



**HESTORE.HU**

elektronikai alkatrész áruház

**EN:** This Datasheet is presented by the manufacturer.

Please visit our website for pricing and availability at [www.hestore.hu](http://www.hestore.hu).

## Acinput Type Photocoupler

LTV814/LTV824/LTV844

LTV814S/LTV824S/LTV844S

LTV814M/LTV824M/LTV844M

### Features

- AC input response
- High input-output isolation voltage :  
( Viso : 5,000V<sub>rms</sub> )
- Low collector dark current  
( I<sub>CEO</sub> : MAX. 10<sup>-7</sup>A at V<sub>CE</sub> = 20V )
- Current transfer ratio  
( CTR : MIN. 20% at I<sub>F</sub> = ± 1mA, V<sub>CE</sub> = 5V )
- Compact dual-in-line package  
LTV814 : 1-channel type  
LTV824 : 2-channel type  
LTV844 : 4-channel type
- UL approved ( No. E113898 )
- TUV approved ( No. R9653630 )
- CSA approved ( No. LR91533 )
- FIMKO approved ( No. 193422 )
- NEMKO approved ( No. P96103013 )
- DEMKO approved ( No. 303986 )
- SEMKO approved ( No. 9646047/01-30 )
- VDE approved ( No. 94722 Thailand )
- Options Available :
  - Leads with 0.4" (10.16mm) Spacing (M Type)
  - Lead Bends for Surface Mounting (S Type)
  - Tape and Reel of Type I for SMD(Add"-TA"Suffix)
  - Tape and Reel of Type II for SMD(Add"-TA1" Suffix)
  - VDE 0884 Approvals (Add "-V" Suffix)

### Applications

1. Telephone sets, telephone exchangers.
2. Sequence controllers.
3. System appliances, measuring instruments.
4. Signal transmission between circuits of different potentials and impedances.

### Package Dimensions

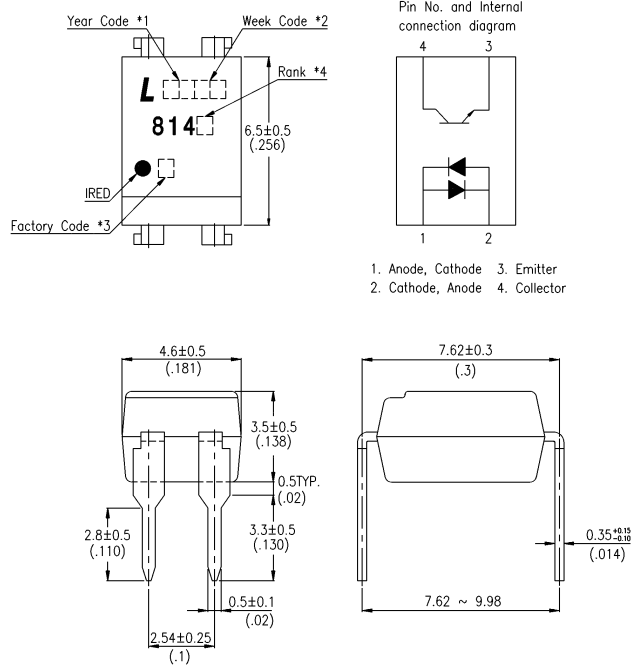

#### Notes :

1. Year date code.
2. 2-digit work week.
3. Factory code shall be marked (Z : Taiwan, Y : Thailand).
4. All dimensions are in millimeters (inches).
5. Tolerance is ± 0.25mm (.010") unless otherwise noted.
6. Specifications are subject to change without notice.

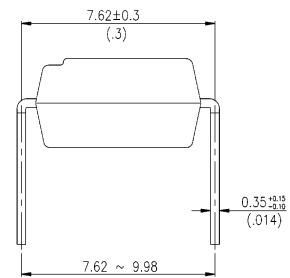
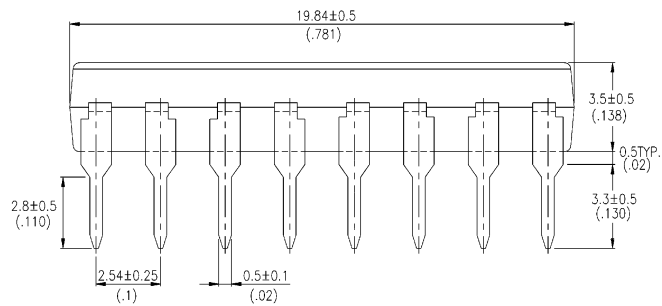
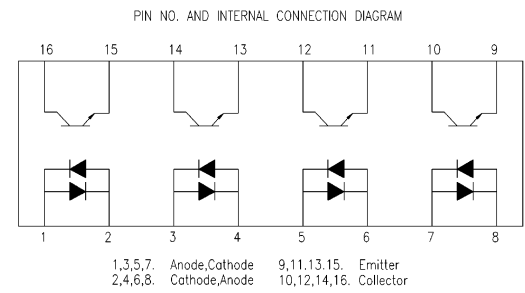
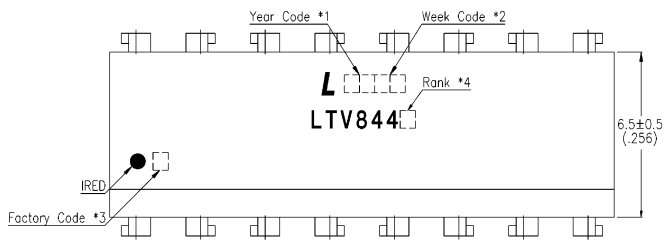
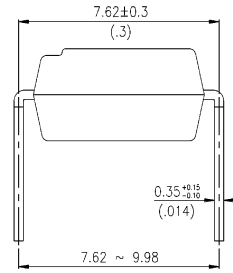
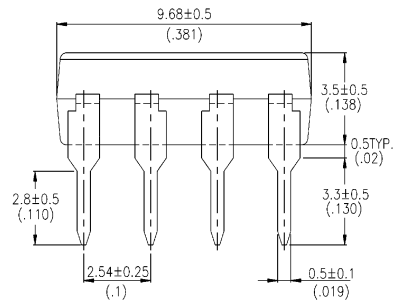
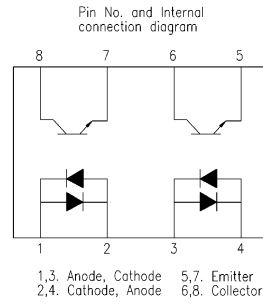
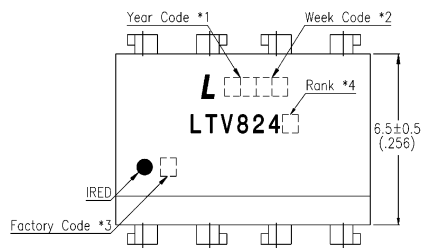

## Absolute Maximum Ratings

(Ta=25 °C)

Parameter		Symbol	Rating	Unit
Input	Forward Current	I <sub>F</sub>	± 50	mA
	Power Dissipation	P	70	mW
Output	Collector-Emitter Voltage	V <sub>CEO</sub>	35	V
	Emitter-Collector Voltage	V <sub>ECO</sub>	6	V
	Collector Current	I <sub>C</sub>	50	mA
	Collector Power Dissipation	P <sub>C</sub>	150	mW
Total Power Dissipation		P <sub>tot</sub>	200	mW
Operating Temperature		T <sub>opr</sub>	-30~+100	°C
Storage Temperature		T <sub>stg</sub>	-55~+125	°C
* 1. Isolation Voltage		V <sub>iso</sub>	5	KV <sub>rms</sub>
* 2. Soldering Temperature		T <sub>sol</sub>	260	°C

PHOTOCOUPPLERS

\* 1. AC for 1 minute, 40 ~ 60%R.H.

• Isolation voltage shall be measured using the following method.

(1) Short between anode and cathode on the primary side and between collector, emitter and base on the secondary side.

(2) The isolation voltage tester with zero-cross circuit shall be used.

(3) The waveform of applied voltage shall be a sine wave.

\* 2. For 10 seconds.

# Electrical/Optical Characteristics

(Ta=25 °C)

Parameter		Symbol	Min.	Typ.	Max.	Unit	Conditions
Input	Forward Voltage	V <sub>F</sub>	—	1.2	1.4	V	I <sub>F</sub> = ± 20mA
	Terminal Capacitance	C <sub>t</sub>	—	50	250	pF	V=0, f=1KHz
Output	Collector Dark Current	I <sub>CEO</sub>	—	—	100	nA	V <sub>CE</sub> =20V
	Collector-Emitter Breakdown Voltage	BV <sub>CEO</sub>	35	—	—	V	I <sub>C</sub> =0.1mA
	Emitter-Collector Breakdown Voltage	BV <sub>ECO</sub>	6	—	—	V	I <sub>E</sub> =10μA
Transfer Characteristics	Collector Current	I <sub>C</sub>	0.2	—	3	mA	I <sub>F</sub> = ± 1mA, V <sub>CE</sub> =5V
	* Current Transfer Ratio	CTR	20	—	300	%	I <sub>F</sub> = ± 1mA, V <sub>CE</sub> =5V
	Collector-Emitter Saturation Voltage	V <sub>CE(sat)</sub>	—	0.1	0.2	V	I <sub>F</sub> = ± 20mA, V <sub>CE</sub> =1V
	Isolation Resistance	R <sub>ISO</sub>	5 × 10 <sup>10</sup>	10 <sup>11</sup>	—	Ω	DC500V, 40~60% R.H.
	Floating Capacitance	C <sub>f</sub>	—	0.6	1.0	pF	V=0, f=1MHz
	Cut-off Frequency	f <sub>c</sub>	15	80	—	KHz	V <sub>CE</sub> =5V, I <sub>F</sub> =2mA R <sub>L</sub> =100 Ω, -3dB
	Response Time (Rise)	t <sub>r</sub>	—	4	18	μs	V <sub>CE</sub> =2V, I <sub>F</sub> =2mA R <sub>L</sub> =100 Ω
	Response Time (Fall)	t <sub>f</sub>	—	3	18	μs	

\* CTR =  $\frac{I_C}{I_F} \times 100\%$

## Typical Electrical/Optical Characteristic Curves (25 °C Ambient Temperature Unless Otherwise Noted)

Fig. 1 Forward Current vs. Ambient Temperature

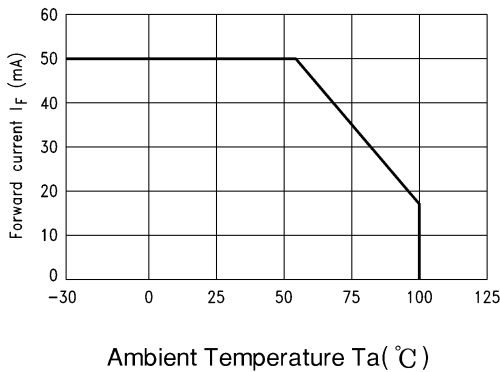
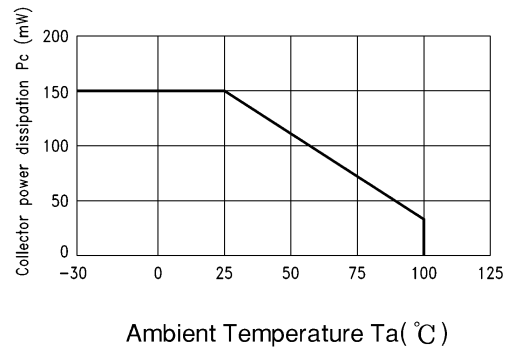
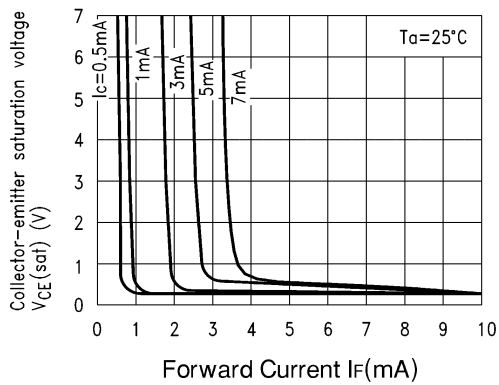

Fig. 2 Collector Power Dissipation Vs. Ambient Temperature



**Fig. 3** Collector-emitter Saturation Voltage Vs. Forward Current



**Fig. 4** Forward Current Vs. Forward Voltage

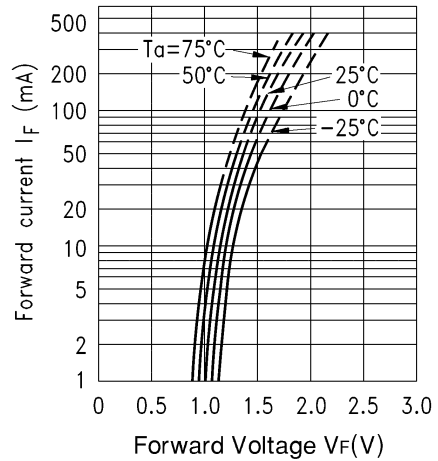

**Fig. 5** Current Transfer Ratio Vs. Forward Current

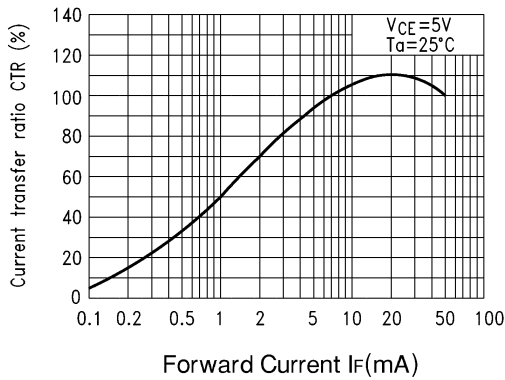

**Fig. 6** Collector Current Vs. Collector-emitter Voltage

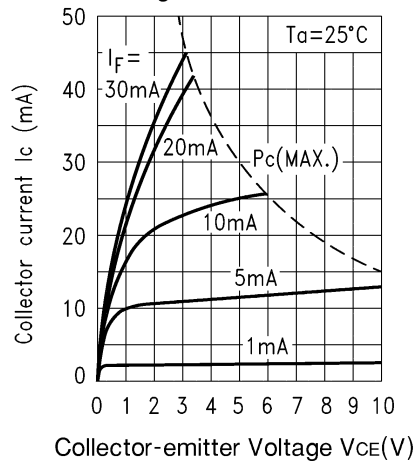

**Fig. 7** Relative Current Transfer Ratio Vs. Ambient Temperature

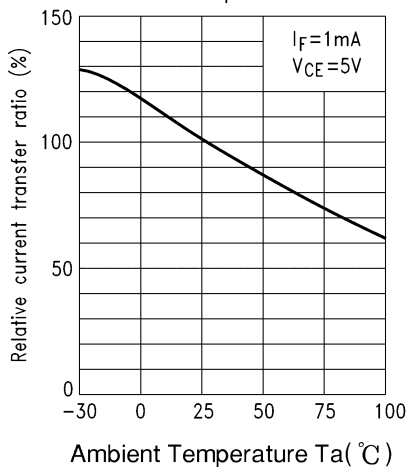

**Fig. 8** Collector-emitter Saturation Voltage Vs. Ambient Temperature

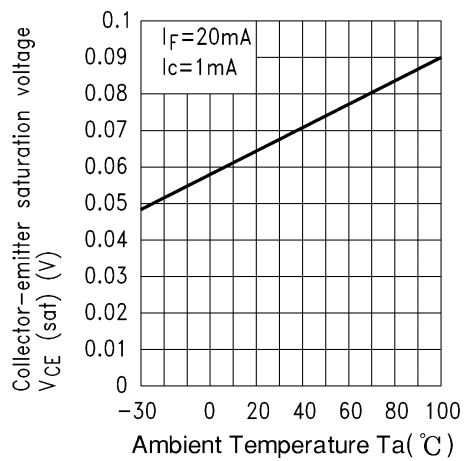

**Fig. 9** Collector Dark Current Vs. Ambient Temperature

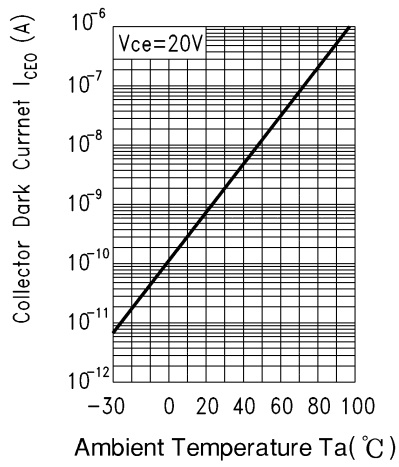

**Fig. 10** Response Time Vs. Load Resistance

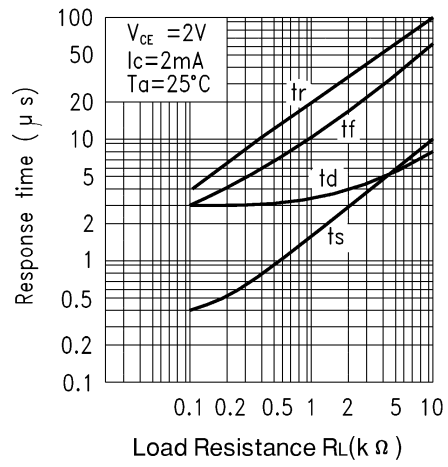

**Fig. 11** Frequency Response

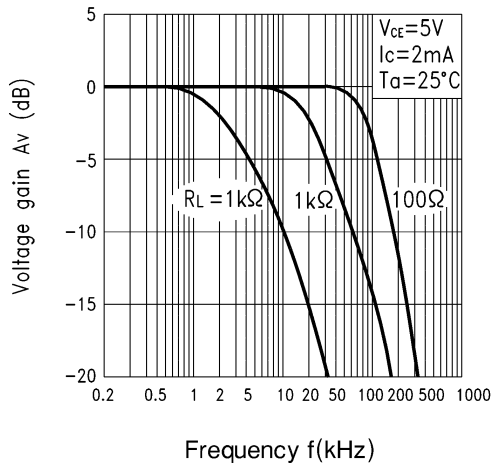

Test Circuit For Response Time

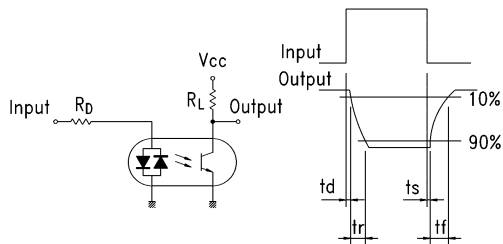

Test Circuit For Frequency Response

