



**HESTORE.HU**

elektronikai alkatrész áruház

**EN:** This Datasheet is presented by the manufacturer.

Please visit our website for pricing and availability at [www.hestore.hu](http://www.hestore.hu).

# 374/375/376

Clamp Meter

**Users Manual**

PN 3608883  
July 2010

© 2010 Fluke Corporation. All rights reserved. Printed in China. Specifications are subject to change without notice.  
All product names are trademarks of their respective companies.

## LIMITED WARRANTY AND LIMITATION OF LIABILITY

This Fluke product will be free from defects in material and workmanship for three years from the date of purchase. This warranty does not cover fuses, disposable batteries, or damage from accident, neglect, misuse, alteration, contamination, or abnormal conditions of operation or handling. Resellers are not authorized to extend any other warranty on Fluke's behalf. To obtain service during the warranty period, contact your nearest Fluke authorized service center to obtain return authorization information, then send the product to that Service Center with a description of the problem.

THIS WARRANTY IS YOUR ONLY REMEDY. NO OTHER WARRANTIES, SUCH AS FITNESS FOR A PARTICULAR PURPOSE, ARE EXPRESSED OR IMPLIED. FLUKE IS NOT LIABLE FOR ANY SPECIAL, INDIRECT, INCIDENTAL OR CONSEQUENTIAL DAMAGES OR LOSSES, ARISING FROM ANY CAUSE OR THEORY. Since some states or countries do not allow the exclusion or limitation of an implied warranty or of incidental or consequential damages, this limitation of liability may not apply to you.

Fluke Corporation  
P.O. Box 9090  
Everett, WA 98206-9090  
U.S.A.

Fluke Europe B.V.  
P.O. Box 1186  
5602 BD Eindhoven  
The Netherlands

# Table of Contents

Title	Page
Introduction.....	1
How to Contact Fluke .....	2
Safety Information .....	3
The Meter .....	9
Specifications .....	19
Electrical Specifications.....	19
Mechanical Specifications .....	26
Environmental Specifications .....	27



## ***Introduction***

### **⚠⚠ Warning**

**Read "Safety Information" before you use the Meter.**

The Fluke 374, 375, and 376 (the Meter) measure true-rms ac current and voltage, dc current and voltage, inrush current, resistance, and capacitance. The 375 and 376 also measure frequency and dc millivolts. The detachable iFlex (Flexible Current Probe) that is included with the 376 (optional with the 374 and 375) expands the measurement range to 2500 A ac. The Flexible Current Probe provides increased display flexibility and allows measurements of awkward sized conductors and improved wire access. The illustrations in this manual show the 376.

## **How to Contact Fluke**

To contact Fluke, call one of the following telephone numbers:

- Technical Support USA: 1-800-44-FLUKE (1-800-443-5853)
- Calibration/Repair USA: 1-888-99-FLUKE (1-888-993-5853)
- Canada: 1-800-36-FLUKE (1-800-363-5853)
- Europe: +31 402-675-200
- Japan: +81-3-3434-0181
- Singapore: +65-738-5655
- Anywhere in the world: +1-425-446-5500

Or, visit Fluke's website at [www.fluke.com](http://www.fluke.com).

To register your product, visit <http://register.fluke.com>.

To see, print, or download the latest manual supplement, visit <http://us.fluke.com/user/support/manuals>.

## **Safety Information**

A **Warning** identifies conditions and actions that pose hazard(s) to the user. A **Caution** identifies conditions and procedures that could cause Meter damage, equipment under test damage, or permanent loss of data.

Symbols used on the Meter and in this manual are explained in Table 1.

### **⚠ ⚠ Warning**

To prevent possible electrical shock or personal injury, follow these guidelines:

- Use the Meter only as specified in this manual or the protection provided by the Meter can be compromised.
- Examine the case before you use the Meter. Look for cracks or missing plastic. Carefully look at the insulation around the connectors.
- Never measure current while the test leads are inserted into the input jacks.
- Make sure the battery door is closed and latched before operating the Meter.
- Remove the test leads from the Meter before the battery door is opened.
- Examine the test leads for damaged insulation or exposed metal. Check test lead continuity. Replace damaged test leads before using the Meter.
- Do not use the Meter if it operates incorrectly. Protection can be compromised. When in doubt, have the Meter serviced.



- Do not use the Meter around explosive gas, vapor or in damp or wet environments.
- Use only type AA batteries, properly installed in the Meter case, to power the Meter.
- When measuring current with the Jaw, keep fingers behind the Tactile Barrier. See "The Meter" ①.
- To avoid false readings that can lead to electrical shock and injury, replace the batteries as soon as the low battery indicator () appears.
- When servicing the Meter, use only specified replacement parts.
- Have the Meter serviced only by qualified service personnel.
- Be careful around voltages > 30 V ac rms, 42 V ac peak, or 60 V dc. Such voltages pose a shock hazard.
- Do not apply more than the rated voltage, as marked on the Meter, between the terminals or between any terminal and earth ground.
- When using the probes, keep fingers behind the finger guards on the probes.
- Connect the common test lead before connecting the live test lead. When disconnecting test leads, disconnect the live test lead first.
- Do not work alone so assistance can be rendered in an emergency.
- Use extreme caution when working around bare conductors or bus bars. Contact with the conductor could result in electric shock.







- **Adhere to local and national safety codes. Individual protective equipment must be used to prevent shock and arc blast injury where hazardous live conductors are exposed.**
- **Disconnect circuit power and discharge all high-voltage capacitors before you measure resistance, continuity, or capacitance.**
- **For the 374 and 375, do not measure ac/dc current in circuits carrying more than 1000 V or 600 A with the Meter Jaw.**
- **For the 376, do not measure ac/dc current in circuits carrying more than 1000 V or 1000 A with the Meter Jaw.**
- **Never operate the Meter with the back cover removed or the case open.**
- **Do not measure ac current in circuits carrying more than 1000 V or 2500 A with the Flexible Current Probe.**
- **Do not apply the Flexible Current Probe around or remove from HAZARDOUS LIVE conductors.**
- **Do not use the flexible current sensor if the inner contrasting insulation color is showing.**
- **Take special care during fitting and removal of the Flexible Current Probe. De-energize the installation under test or wear suitable protective clothing.**

**⚠ Caution**









To avoid possible damage to the Meter or to equipment under test:

- Use the proper jacks, function, and range for the measurement application.
- Clean the case and accessories with a damp cloth and mild detergent only. Do not use abrasives or solvents.

**Table 1. Symbols**

<b>Symbol</b>	<b>Meaning</b>	<b>Symbol</b>	<b>Meaning</b>
	AC (Alternating Current)		Earth ground
	DC (Direct Current)		Do not dispose of this product as unsorted municipal waste. Go to Fluke's website for recycling information.
	Hazardous voltage		Conforms to European Union directives.

## Clamp Meters Safety Information

Symbol	Meaning	Symbol	Meaning
	Risk of Danger. Important information. See Manual.		Conforms to relevant North American Safety Standards.
	Battery. Low battery when shown on display.		Double insulated
	Examined and licensed by TÜV Product Services.		Conforms to relevant Australian standards.
	Do not apply to or remove from HAZARDOUS LIVE conductors.		Application around and removal from HAZARDOUS LIVE conductors is permitted.

<b>Symbol</b>	<b>Meaning</b>	<b>Symbol</b>	<b>Meaning</b>
CAT III	IEC Measurement Category III CAT III equipment has protection against transients in equipment in fixed-equipment installations, such as distribution panels, feeders and short branch circuits, and lighting systems in large buildings.	CAT IV	IEC Measurement Category IV CAT IV equipment has protection against transients from the primary supply level, such as an electricity Meter or an overhead or underground utility service.

*Note*

*The Measurement Category (CAT) and voltage rating of any combination of test probe, test probe accessory, current clamp accessory, and the Meter is the LOWEST rating of any individual component.*

## The Meter

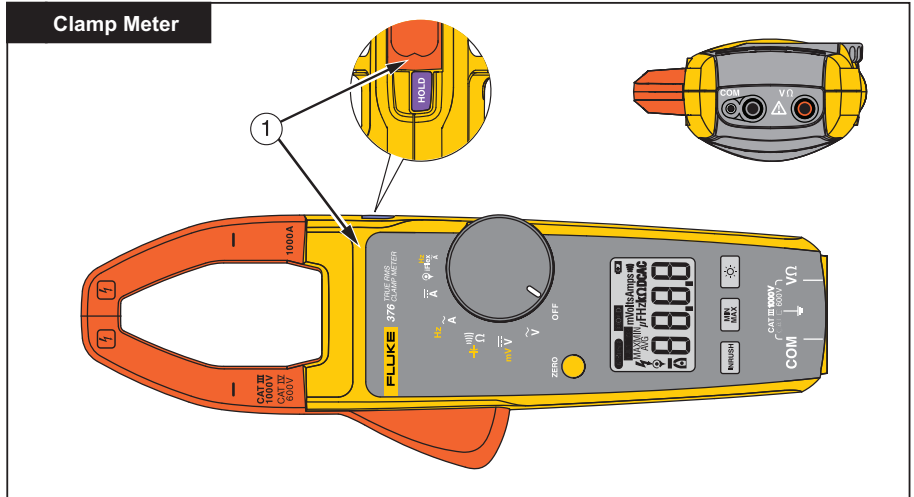

fig01.eps

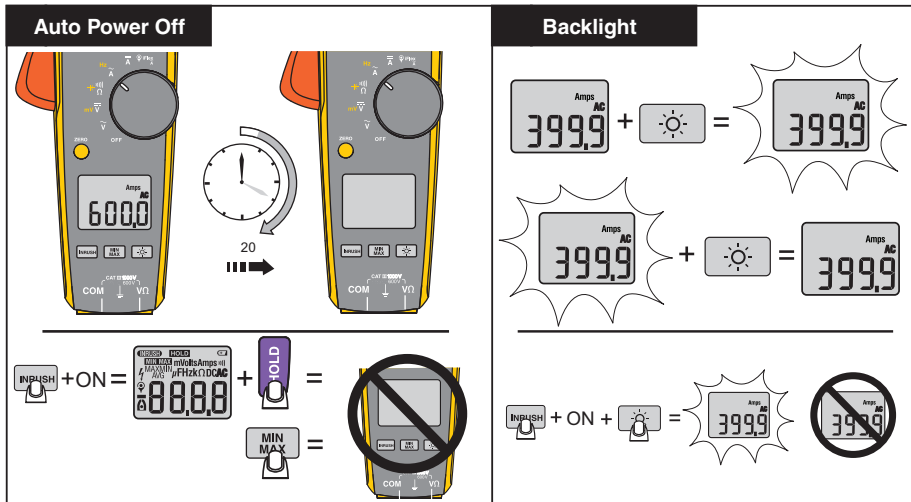
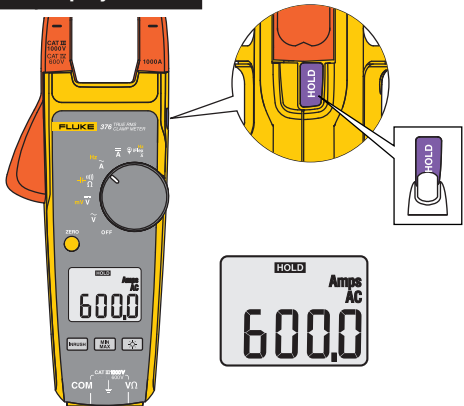

fig02\_3.eps

### Display Hold



The diagram shows a yellow and orange Fluke 376 clamp meter. The display shows '600.0' with 'Amps AC' and '6000' above it. A callout bubble points to a purple 'HOLD' button on the top of the meter. Below the meter, a separate display shows 'HOLD' and '600.0'.

### MIN MAX AVG

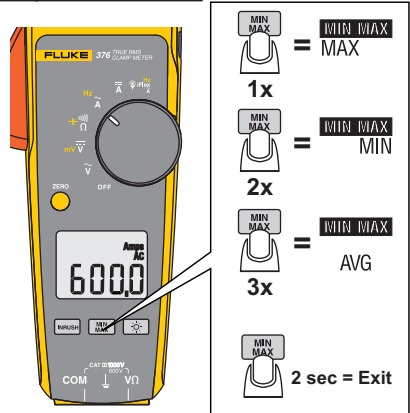

The diagram shows the same Fluke 376 clamp meter. The display shows '600.0' with 'Amps AC' and '6000' above it. A callout bubble points to a 'MIN MAX' button on the bottom of the meter. To the right, a legend explains the button's functions:







-  =  = MAX
- 1x**
-  =  = MIN
- 2x**
-  =  = AVG
- 3x**
-  **2 sec = Exit**

fig04\_5.eps



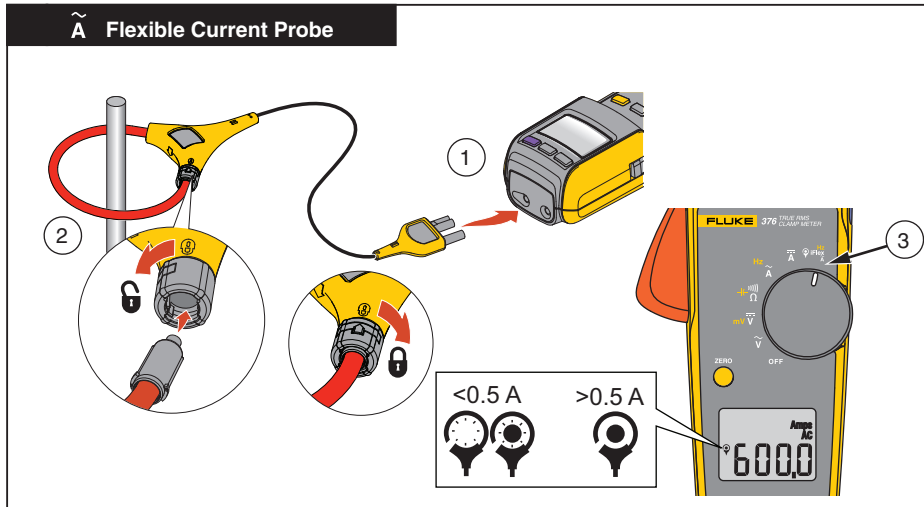

fig06.eps

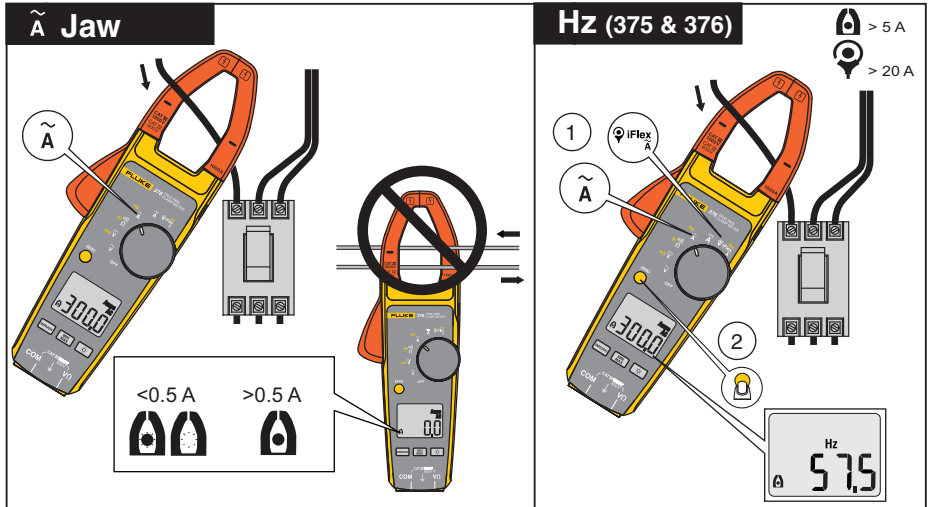

Fig07.eps

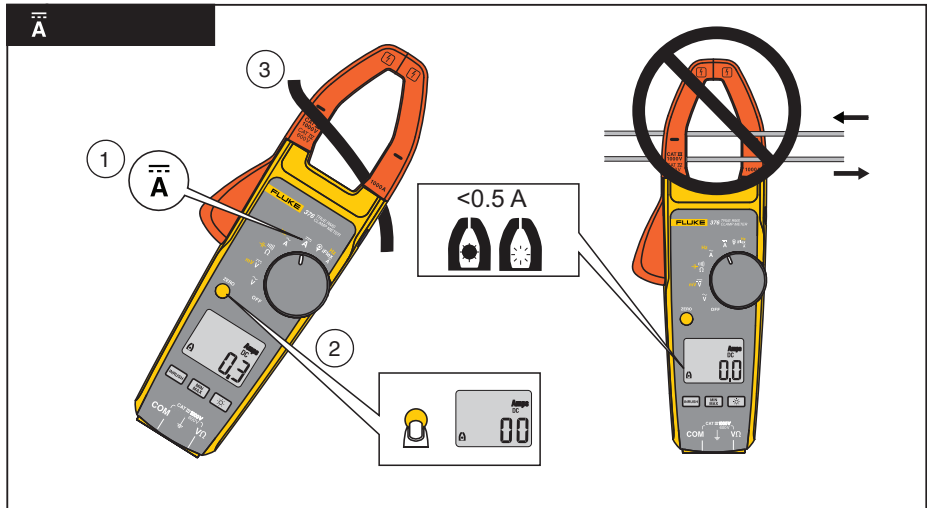

Fig08.eps



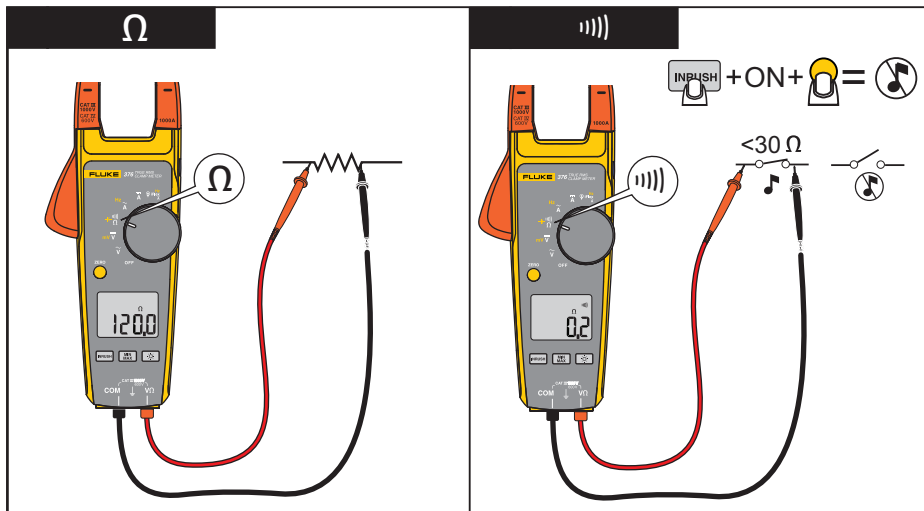

Fig15.eps

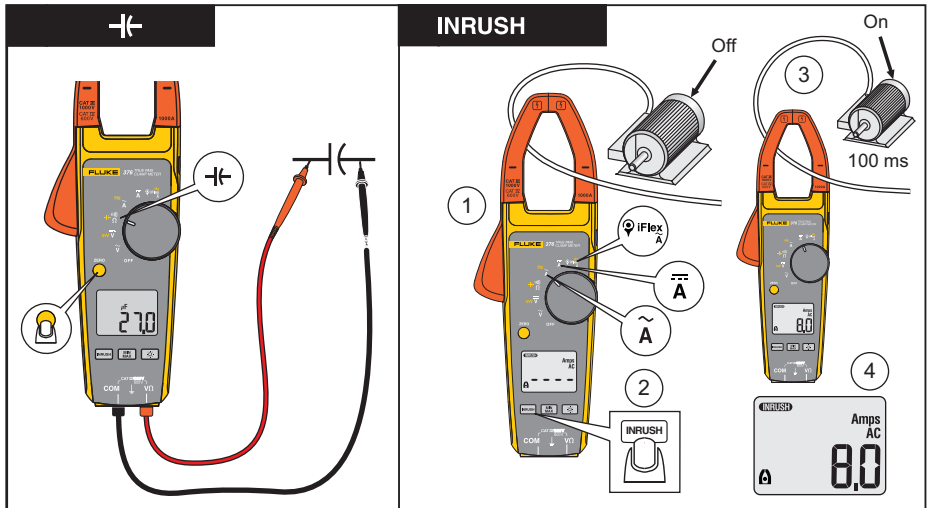

fig13\_14.eps

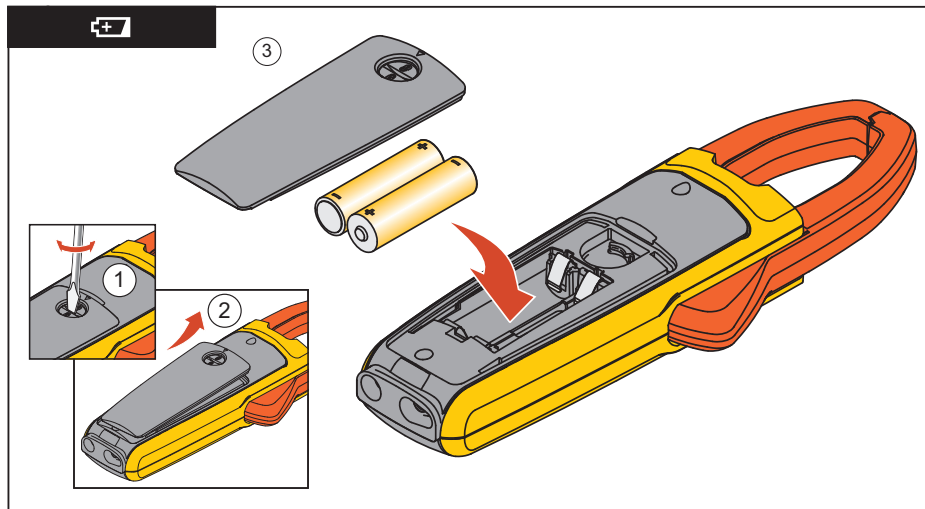

fig11\_12.eps

## **Specifications**

### **Electrical Specifications**

#### *AC Current via Jaw*

##### Range

374 and 375 ..... 600.0 A

376..... 999.9 A

Resolution ..... 0.1 A

Accuracy ..... 2 %  $\pm$  5 digits (10-100 Hz)

2.5 %  $\pm$  5 digits (100-500 Hz)

Crest Factor (50/60 Hz) ..... 3 @ 500 A (375 and 376 only)

2.5 @ 600 A

1.42 @ 1000 A (376 only)

Add 2 % for C.F. > 2



*AC Current via Flexible Current Probe*

Range .....	2500 A
Resolution	
374 and 375 .....	0.1 A ( $\leq 600$ A)
	1 A ( $\leq 2500$ A)
376 .....	0.1 A ( $\leq 999.9$ A)
	1 A ( $\leq 2500$ A)
Accuracy .....	3 % $\pm 5$ digits (5 – 500 Hz)
Crest Factor (50/60Hz) .....	3.0 at 1100 A (375 and 376 only)
	2.5 at 1400 A
	1.42 at 2500 A
	Add 2 % for C.F. > 2

*Position Sensitivity*

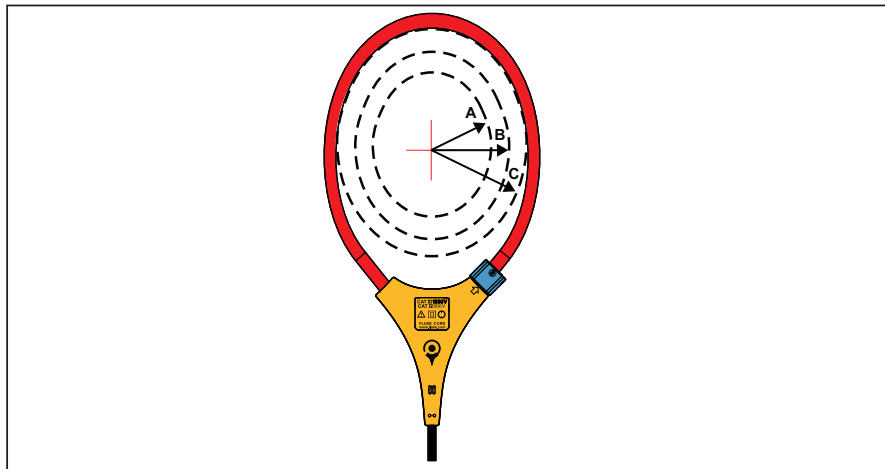

ghn12.eps

**Figure 1. Position Sensitivity**

**374, 375, 376**  
*Users Manual*

<b>Distance from Optimum</b>	<b>i2500-10 Flex</b>	<b>i2500-18 Flex</b>	<b>Error</b>
A	0.5 in (12.7 mm)	1.4 in (35.6 mm)	± 0.5 %
B	0.8 in (20.3 mm)	2.0 in (50.8 mm)	± 1.0 %
C	1.4 in (35.6 mm)	2.5 in (63.5 mm)	± 2.0 %

Measurement uncertainty assumes centralized primary conductor at optimum position, no external electrical or magnetic field, and within operating temperature range.

**DC Current**

Range

374 and 375 ..... 600.0 A

376..... 999.9 A

Resolution ..... 0.1 A

Accuracy ..... 2 % ± 5 digits

**AC Voltage**

Range

374 and 375 ..... 600.0 V

376 ..... 1000 V

Resolution

374 and 375 ..... 0.1 V

376 ..... 0.1 V ( $\leq 600.0$  V)

1 V ( $\leq 1000$  V)

Accuracy ..... 1.5 %  $\pm$  5 digits (20 – 500 Hz)

*DC Voltage*

Range

374 and 375 ..... 600.0 V

376 ..... 1000 V

## 374, 375, 376

### Users Manual

---

#### Resolution

374 and 375 .....	0.1 V
376 .....	0.1 V ( $\leq 600.0$ V)
	1 V ( $\leq 1000$ V)

Accuracy ..... 1 %  $\pm$  5 digits

#### *mV dc*

#### Range

375 and 376..... 500.0 mV

Resolution ..... 0.1 mV

Accuracy ..... 1 %  $\pm$  5 digits

#### *Frequency via Jaw*

#### Range

375 and 376..... 5.0 - 500.0 Hz

Resolution ..... 0.1 Hz

Accuracy ..... 0.5 %  $\pm$  5 digits

Trigger Level .....	5 – 10 Hz, $\geq 10$ A
	10 – 100 Hz, $\geq 5$ A
	100 – 500 Hz, $\geq 10$ A

*Frequency via Flexible Current Probe*

Range

375 and 376 .....	5.0 – 500.0 Hz
Resolution .....	0.1 Hz
Accuracy .....	0.5 % $\pm$ 5 digits
Trigger Level .....	5 – 20 Hz, $\geq 25$ A
	20 – 100 Hz, $\geq 20$ A
	100 – 500 Hz, $\geq 25$ A

*Resistance*

Range

374.....	6000 $\Omega$
375 and 376.....	60 k $\Omega$

Resolution

374..... 0.1  $\Omega$  ( $\leq$  600  $\Omega$ )

1  $\Omega$  ( $\leq$  6000  $\Omega$ )

375 and 376..... 0.1  $\Omega$  ( $\leq$  600  $\Omega$ )

1  $\Omega$  ( $\leq$  6000  $\Omega$ )

10  $\Omega$  ( $\leq$  60 k $\Omega$ )

Accuracy ..... 1 %  $\pm$  5 digits

**Capacitance**

Range ..... 1000  $\mu$ F

Resolution..... 0.1  $\mu$ F ( $\leq$  100  $\mu$ F)

1  $\mu$  F ( $\leq$  1000  $\mu$ F)

Accuracy ..... 1 %  $\pm$  4 digits

**Mechanical Specifications**

Size (L x W x H) ..... 246 mm x 83 mm x 43 mm

Weight..... 388 g

Jaw Opening..... 34 mm

Flexible Current Probe Diameter ..... 7.5 mm

Flexible Current Probe Cable Length

(head to electronics connector)..... 1.8 m

***Environmental Specifications***

Operating Temperature..... -10 °C – +50 °C

Storage Temp ..... -40 °C – +60 °C

Operating Humidity ..... Non condensing (< 10 – °C)  
≤ 90 % RH (at 10 °C – 30 °C)  
≤ 75 % RH (at 30 °C – 40 °C)  
≤ 45 % RH (at 40 °C – 50 °C)

Operating Altitude ..... 3000 meters

Storage Altitude ..... 12,000 meters

EMC ..... EN 61326-1:2006

Temperature Coefficients..... Add 0.1 x specified accuracy for each degree C above  
28 °C or below 18 °C



**Safety Specifications**

Safety Compliance..... CAN/CSA-C22.2 No. 61010-1-04  
ANSI/UL 61010-1:2004  
ANSI/ISA-61010-1 (82.02.01):2004  
EN/IEC 61010-1:2001 to  
1000V Measurement Category (CAT) III  
600V Measurement Category (CAT) IV  
Pollution Degree 2  
EN/IEC 61010-2-032:2002  
EN/IEC 61010-031:2002+A1:2008



Agency Approvals.....



Batteries..... 2 AA, NEDA 15A, IEC LR6