



HESTORE.HU

elektronikai alkatrész áruház

EN: This Datasheet is presented by the manufacturer.

Please visit our website for pricing and availability at www.hestore.hu.



Features

- SMD Single-Turn / Cermet / Industrial Open Frame
- Cross slot rotor designs suitable for automatic adjustment equipment
- Supplied in 12 mm embossed tape, compatible with automatic pick-and-place assembly equipment
- Recommended for reflow solder processing only
- RoHS compliant* - see [processing information](#) on lead free surface mount trimmers

3364 - 4 mm Square Trimming Potentiometer

Electrical Characteristics

Standard Resistance Range
100 ohms to 1 megohm
 (see standard resistance table)
 Resistance Tolerance±25 % std.
 End Resistance
 <1K20 ohms max.
 >1K2 %
 Contact Resistance Variation
 (Voltage Divider)5 % max.
 ResolutionInfinite
 Adjustment Angle260 °±20 °

Environmental Characteristics

Power Rating (50 volts max.)
 70 °C0.2 watt
 Temperature Range-40 °C to +100 °C
 Temperature Coefficient±250 ppm/°C
 Humidity500 hours (5 % ΔTR)
 Load Life500 hours
 0.2 watt @ 70 °C (5 % ΔTR)
 Rotational Life20 cycles (15% ΔTR)

Physical Characteristics

Torque20 to 200 g-cm
 Mechanical AngleContinuous
 MarkingResistance code,
 manufacturer's full part number
 and date code on packaging
 TerminalsSolder coated
 Standard Packaging
1000 pcs./7 " reel
 Adjustment ToolH-90
 Reflow solder processing recommended

How To Order

3364 X - 1 - 103 E

Model _____
 Style _____
 Orientation of parts in tape:
 Styles W,A
 Terminals toward sprocket holes
 Styles X,B
 Terminals away from sprocket holes
 Standard Product _____
 Resistance Code _____
 Embossed Tape Designator _____
 E = 1000 pcs./7 " reel (-1 standard)
 G = 5000 pcs./14.5 " reel (-1 optional)
 Consult factory for other available options.

Common Dimensions 3364W, X 3-Terminal

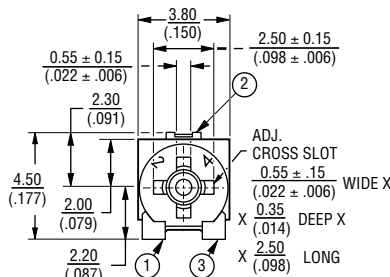

3364A, B 3-Terminal

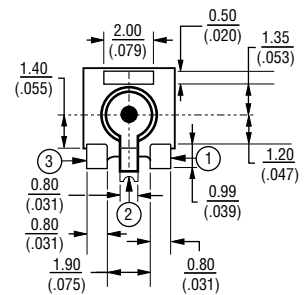
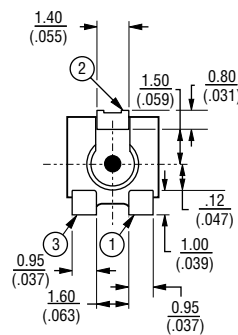
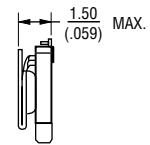
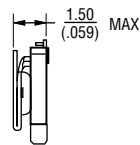
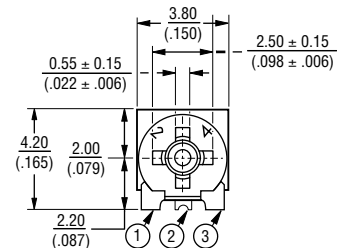

SUGGESTED PWB LAYOUT

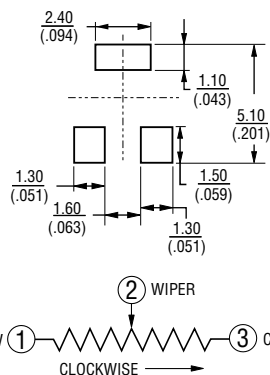

SUGGESTED PWB LAYOUT

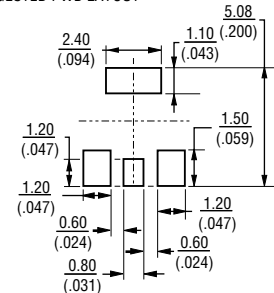

TOLERANCES: ± 0.25 (.010) EXCEPT WHERE NOTED

DIMENSIONS ARE: $\frac{\text{MM}}{\text{(INCHES)}}$

*RoHS Directive 2002/95/EC Jan 27 2003 including Annex.
 Specifications are subject to change without notice.
 Customers should verify actual device performance in their specific applications.

3364 - 4 mm Square Trimming Potentiometer

BOURNS®

Packaging Specifications

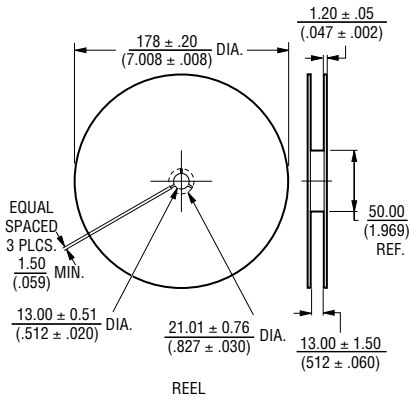
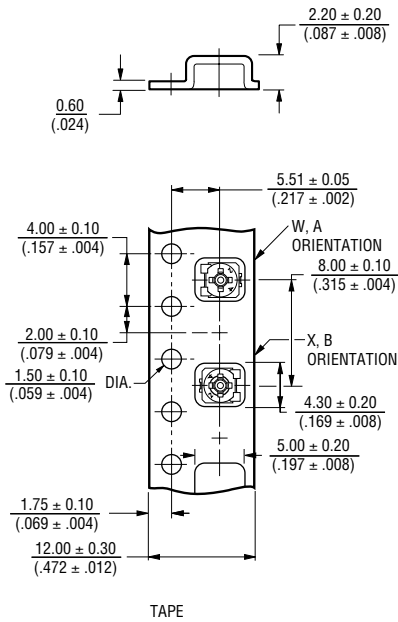

Conforms with EIA specification RS-481.

Standard Resistance Table

Resistance (Ohms)	Resistance Code	Part Marking
100	101	12
200	201	22
500	501	52
1,000	102	13
2,000	202	23
5,000	502	53
10,000	103	14
20,000	203	24
50,000	503	54
100,000	104	15
200,000	204	25
500,000	504	55
1,000,000	105	16

Popular distribution resistance values listed in boldface.