



**HESTORE.HU**

elektronikai alkatrész áruház

**EN:** This Datasheet is presented by the manufacturer.

Please visit our website for pricing and availability at [www.hestore.hu](http://www.hestore.hu).



# FTR-B4 Series

## ■ PART NUMBERS

Standard type

Ordering Part Number	Series	Terminal Type	Operation	Coil Voltage	Contact Material
FTR-B4CA1.5Z	FTR-B4	C: through hole	A: mono-stable (standard type)	1.5	Z: Au-Ag-Ni P: Au-Ag-Pd
FTR-B4CA003Z				3	
FTR-B4CA4.5Z				4.5	
FTR-B4CA006Z				6	
FTR-B4CA009Z				9	
FTR-B4CA012Z				12	
FTR-B4CA024Z				24	
FTR-B4GA1.5Z		G: surface mount		1.5	
FTR-B4GA003Z				3	
FTR-B4GA4.5Z				4.5	
FTR-B4GA006Z				6	
FTR-B4GA009Z				9	
FTR-B4GA012Z				12	
FTR-B4GA024Z				24	
FTR-B4SA1.5Z		S: space saving surface mount		1.5	
FTR-B4SA003Z				3	
FTR-B4SA4.5Z				4.5	
FTR-B4SA006Z				6	
FTR-B4SA009Z	9				
FTR-B4SA012Z	12				
FTR-B4SA024Z	24				

# FTR-B4 Series

Latching type (1 coil)

Ordering Part Number	Series	Terminal Type	Operation	Coil Voltage	Contact Material		
FTR-B4CB1.5Z	FTR-B4	C: through hole	B: latching	1.5	Z: Au-Ag-Ni P: Au-Ag-Pd		
FTR-B4CB003Z				3			
FTR-B4CB4.5Z				4.5			
FTR-B4CB006Z				6			
FTR-B4CB009Z				9			
FTR-B4CB012Z				12			
FTR-B4CB024Z				24			
FTR-B4GB1.5Z		G: surface mount		B: latching		1.5	
FTR-B4GB003Z						3	
FTR-B4GB4.5Z						4.5	
FTR-B4GB006Z						6	
FTR-B4GB009Z						9	
FTR-B4GB012Z						12	
FTR-B4GB024Z						24	
FTR-B4SB1.5Z		S: space saving surface mount				B: latching	1.5
FTR-B4SB003Z							3
FTR-B4SB4.5Z							4.5
FTR-B4SB006Z							6
FTR-B4SB009Z							9
FTR-B4SB012Z							12
FTR-B4SB024Z							24

## ■ COIL DATA CHART

Standard type

Coil Voltage	Nominal Voltage (VDC)	Max. Coil Voltage* <sup>1</sup>	Coil Resistance (±10%)	Must Operate Voltage* <sup>2</sup>	Must Release Voltage* <sup>2</sup>	Nominal Power (mW)
1.5	1.5	3.53 VDC	16.1 Ω	1.13 VDC	0.15 VDC	140
003	3	7.05 VDC	64.3 Ω	2.25 VDC	0.3 VDC	
4.5	4.5	10.58 VDC	145 Ω	3.38 VDC	0.45 VDC	
006	6	14.10 VDC	257 Ω	4.5 VDC	0.6 VDC	
009	9	21.15 VDC	579 Ω	6.75 VDC	0.9 VDC	
012	12	28.20 VDC	1,028 Ω	9.0 VDC	1.2 VDC	
024	24	56.40 VDC	2,504 Ω	18.0 VDC	2.4 VDC	230

\*1: No contact current at 20°C. Please see 'operating range' data for other conditions.

\*2: Specified values are subject to pulse wave voltage.

# FTR-B4 Series

Latching type (1 coil)

Coil Voltage	Nominal Voltage (VDC)	Max. Coil Voltage* <sup>1</sup>	Coil Resistance (±10%)	Must Operate Voltage* <sup>2</sup>	Must Release Voltage* <sup>2</sup>	Set/Re-set current	Nominal Power (mW)
1.5	1.5	3.53 VDC	22.5 Ω	1.13 VDC	-0.13 VDC	50mA	100
003	3	7.05 VDC	90 Ω	2.25 VDC	-2.25 VDC	25mA	
4.5	4.5	10.58 VDC	203 Ω	3.38 VDC	-3.38 VDC	17mA	
006	6	14.10 VDC	360 Ω	4.5 VDC	-4.5 VDC	13mA	
009	9	21.15 VDC	810 Ω	6.75 VDC	-6.75 VDC	8mA	
012	12	28.20 VDC	1,440 Ω	9.0 VDC	-9.0 VDC	6mA	
024	24	56.40 VDC	4,800 Ω	18.0 VDC	-18.0 VDC	4mA	120

Note: All values in the table are measured at 20°C.

\*1: No contact current at 20°C. Please see 'operating range' data for other conditions.

\*2: Specified values are subject to pulse wave voltage.

## ■ SPECIFICATIONS

		Standard Type	Latching Type
		FTR-B4 ( ) A	FTR-B4 ( ) B
Contact	Arrangement	2 Form C	
	Contact material	Gold overlay silver nickel / Gold overlay silver palladium	
	Contact type	Bifurcated contact (cross-bar)	
	Contact resistance (initial value)	100mΩ maximum at 6VDC 1	
	Contact rating	30 VDC 1A, 125 VAC 0.3 A (resistive)	
	Maximum carrying current	2A	
	Maximum switching power	62.5 VA / 30W	
	Maximum switching voltage	250 VAC/ 220 VDC	
	Minimum switching load*	10m VDC, 0.01mA*	
Coil	Nominal power (at 20°C)	140 mW up to 230 mW	100 mW up to 130 mW
	Operate power (at 20°C)	80 mW up to 130 mW	57 mW up to 68 mW
	Operating temperature (no frost)	-40°C to +85°C	
Time value	Operate (at nominal voltage, without bounce)	3ms maximum	3ms maximum (set)
	Release (at nominal voltage, without bounce)	3ms maximum	3ms maximum (reset)
Life	Mechanical	50 x 10 <sup>6</sup> operations	20 x 10 <sup>6</sup> operations
	Electrical (resistive load)	DC load	100 x 10 <sup>3</sup> ops. min. at 1A, 30 VDC (at 0.5 Hz)
		AC load	100 x 10 <sup>3</sup> ops. min. at 0.3A, 125VAC (at 0.5 Hz)
Vibration resistance	Misoperation	10 to 55 Hz at double amplitude of 3 mm	
	Endurance	10 to 55 Hz at double amplitude of 5 mm	
Shock resistance	Misoperation	Min. 750 m/s <sup>2</sup>	
	Endurance	Min. 1,000 m/s <sup>2</sup>	
Weight	Approximately 1.0 g		
US/CSA	Contact rating	0.5A, 125 VAC; 1A, 30 VDC; 0.3A, 110 VDC	

\*1 Minimum switching loads mentioned above are reference values. Please perform the confirmation test with the actual load before production since reference values may vary according to switching frequencies, environmental conditions and expected reliability levels.

## CHARACTERISTIC DATA

### Standard type

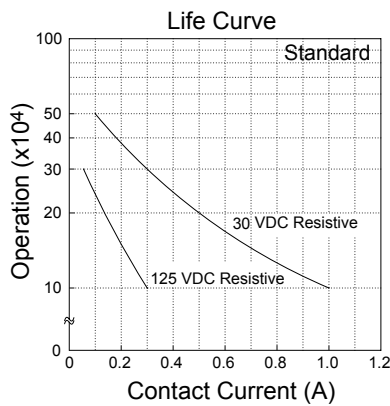
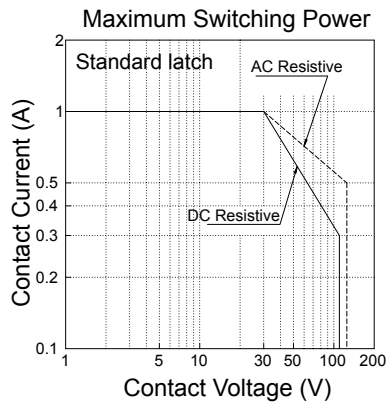
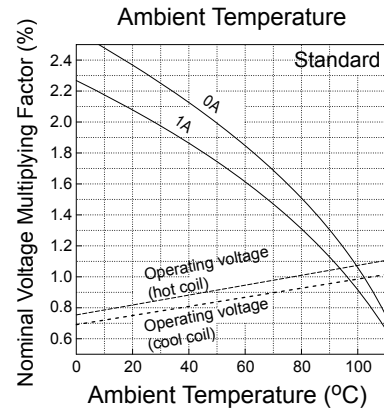
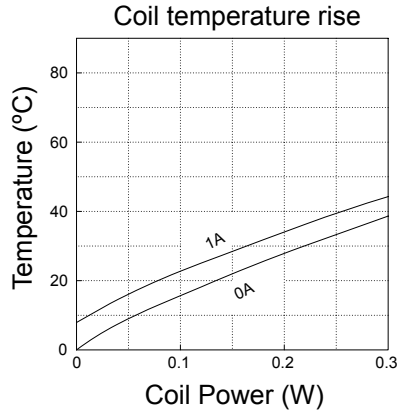
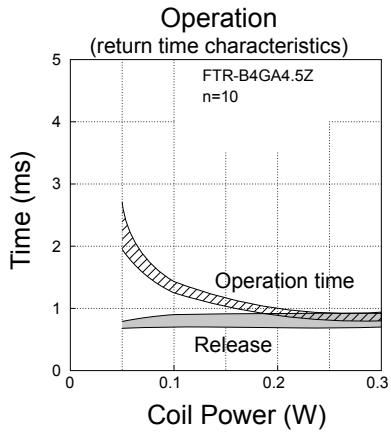

### Latching type

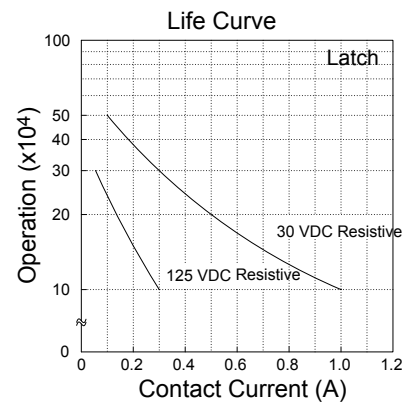
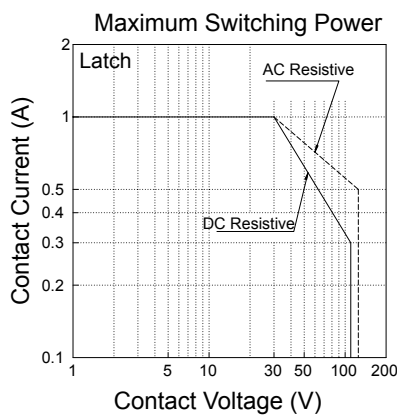
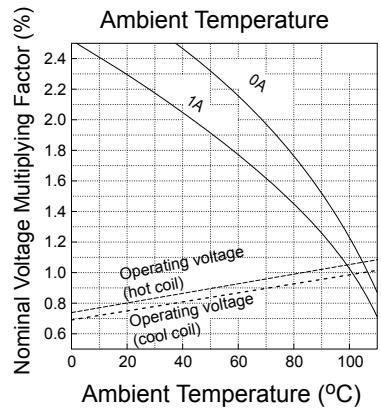
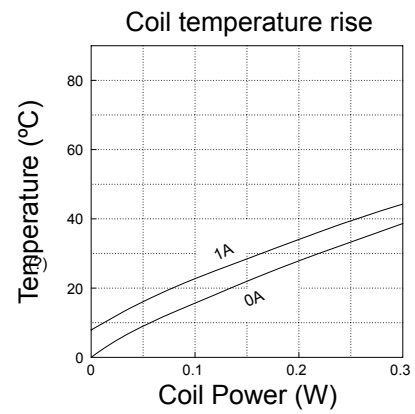
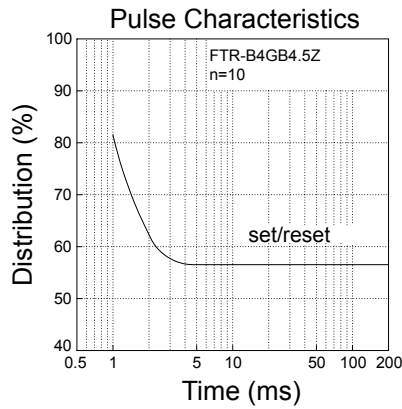
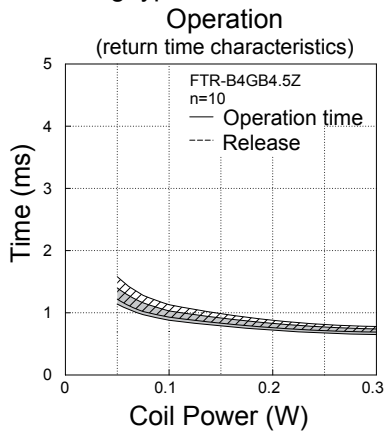

# FTR-B4 Series

## ■ REFERENCE DATA

- Standard type

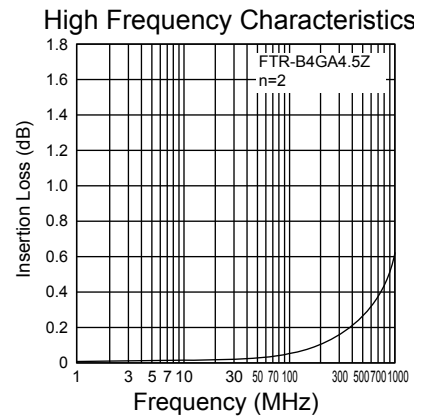
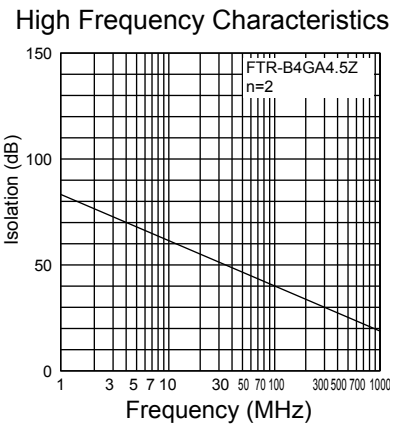
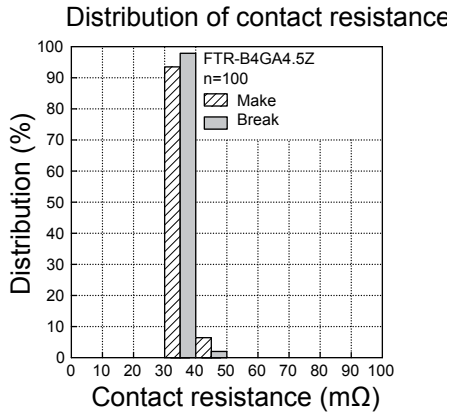
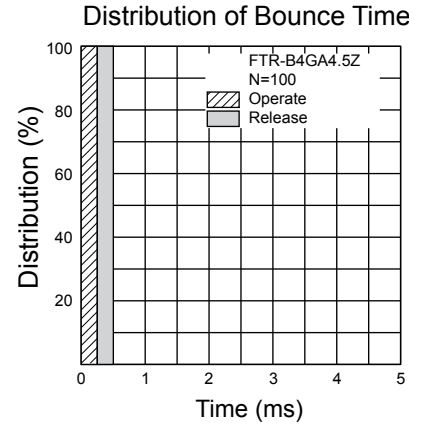
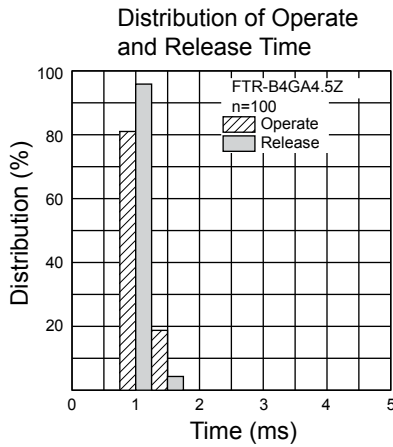
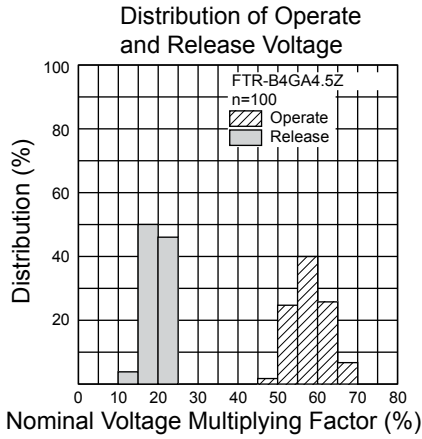

- Latching type

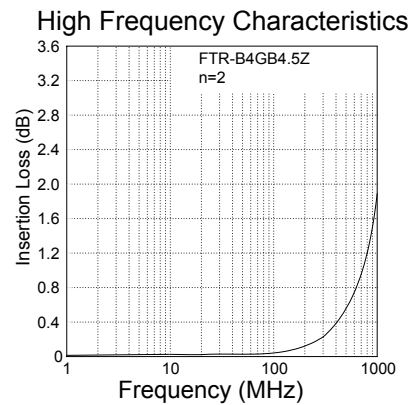
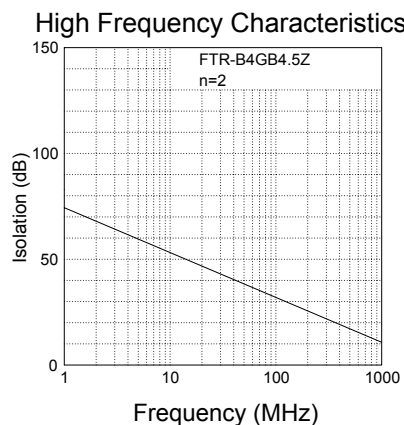
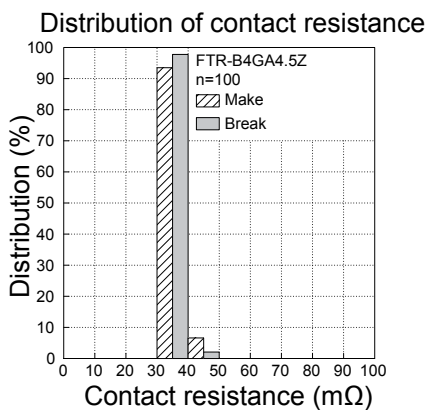
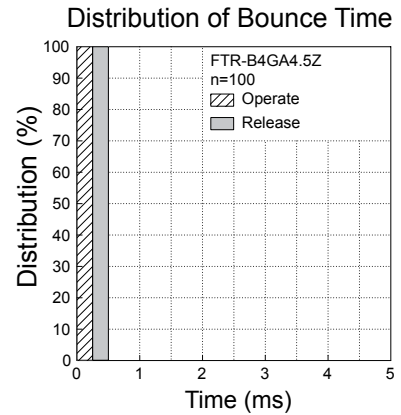
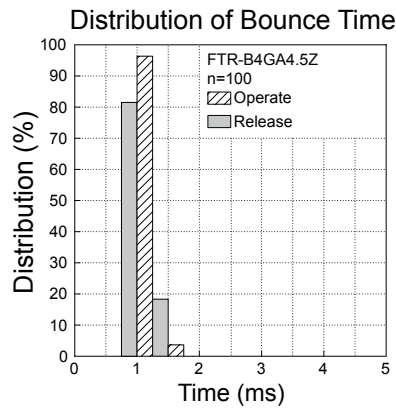
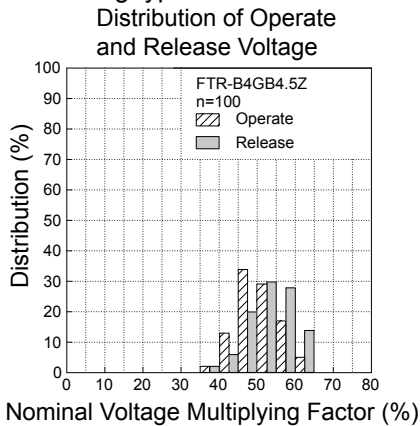

# FTR-B4 Series

## ■ DIMENSIONS AND SCHEMATICS

Through hole type

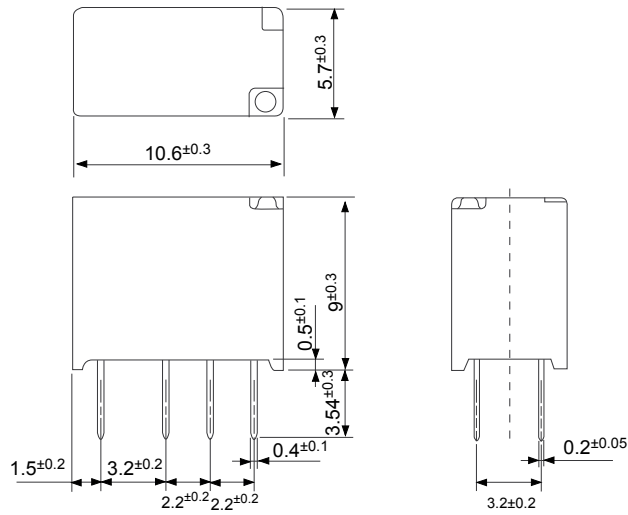

Recommended mounting pad  
(Tolerance:  $\pm 0.1\text{mm}$ )

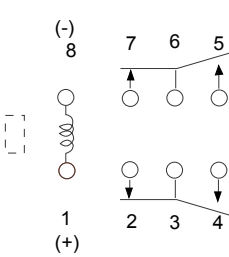

Terminal designations  
(Top view de-energized position)

Surface mount type (standard)

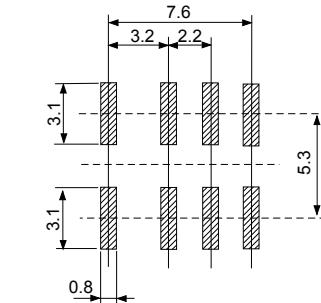
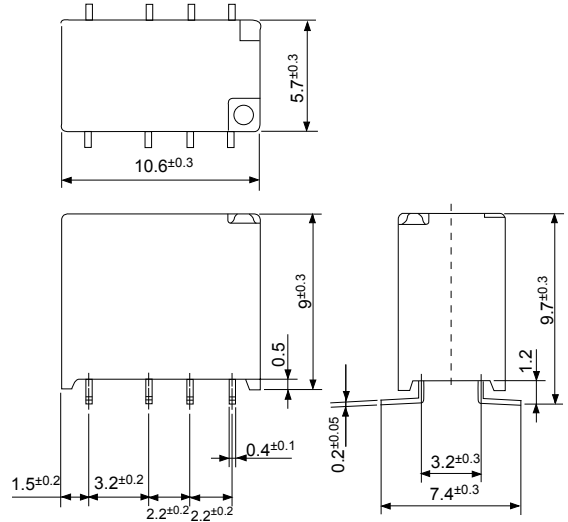

Recommended mounting pad  
(Tolerance:  $\pm 0.1\text{mm}$ )

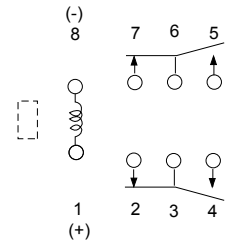

Terminal designations  
(Top view de-energized position)



## ■ DIMENSIONS AND SCHEMATICS

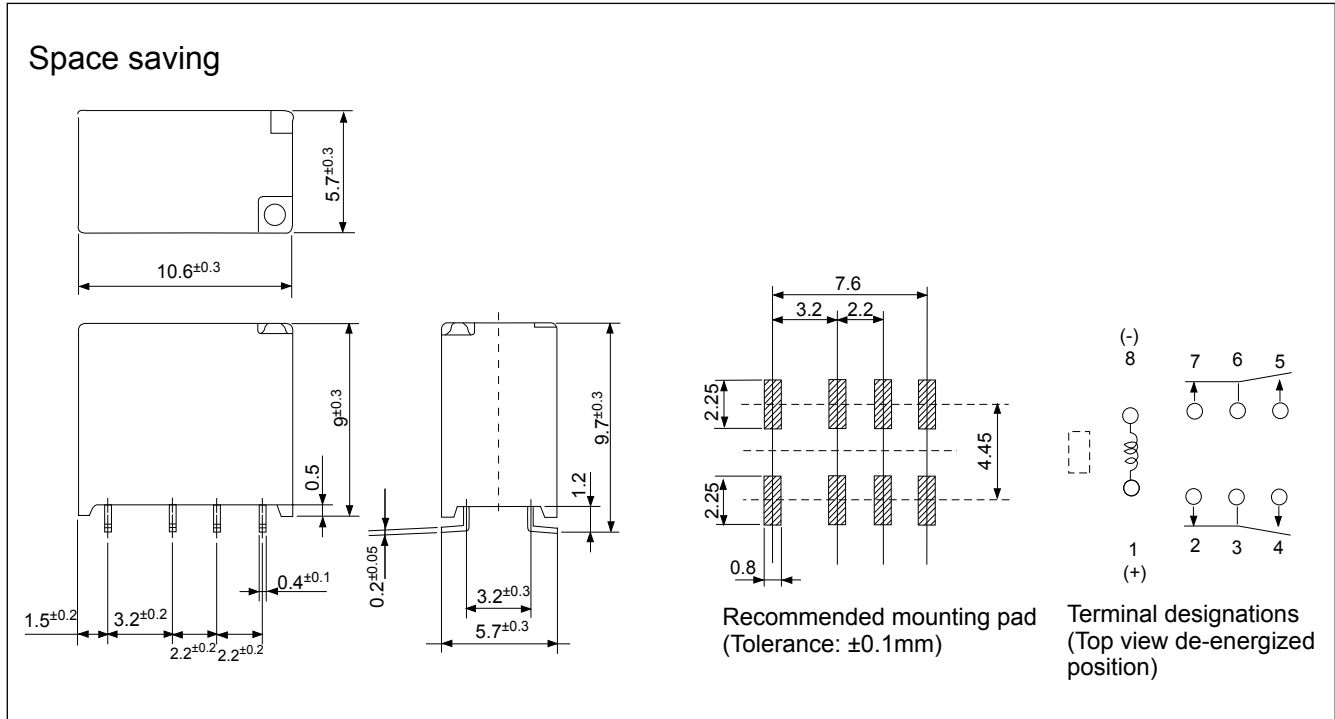

## ■ RECOMMENDED SOLDERING CONDITIONS FOR SMT (TEMPERATURE PROFILE)

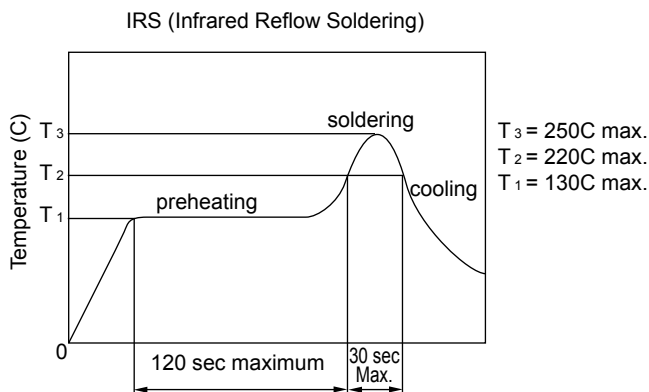

- Note:
1. Temperature profiles show the temperature of PC board surface.
  2. Please perform soldering test with your actual PC board before mass production, since the temperatures of PC board surfaces vary according to the size of PC board, status of parts mounting and heating method.

## ■ PRECAUTIONS

- For details on general precautions, refer to the section on technical descriptions.
- Since this is a polarized relay, follow the instructions of the internal wiring diagram for the +/- connections of the coil.
- Note that the terminal layout and internal wiring of the surface mount relay are a top view.
- SMT versions of the FTR-B4 relays have moisture sensitivity level 3, acc. JEDEC-J-STD-020D
- SMT versions of the FTR-B4 relays will be shipped in "Dry Pack". Relays have an "Out of Bag" storage time of 192h.

## RoHS Compliance and Lead Free Relay Information

### 1. General Information

- If applicable, relays produced after the specific date code that is indicated on each data sheet are lead-free now. All of our signal and power relays are lead-free. Please refer to Lead-Free Status Info. (<http://www.fujitsu.com/us/downloads/MICRO/fcai/relays/lead-free-letter.pdf>)
  - Lead free solder plating currently used in relays is Sn-3.0Ag-0.5Cu. From February 2005 forward Sn-3.0Cu-Ni will be used for the FTR-B3 and FTR-B4 series relays.
  - All signal and power relays also comply with RoHS. Please refer to individual data sheets. Relays that are RoHS compliant do not contain the 5 hazardous materials that are restricted by RoHS directive (lead, mercury, chromium IV, PBB, PBDE, decaBDE and PFOS).
  - It has been verified that using lead-free relays in leaded assembly process will not cause any problems (compatible).
  - "LF" is marked on each outer and inner carton. (No marking on individual relays).
  - To avoid lead containing relays (for lead-free sample, etc.) please consult with area sales office.
  - We will ship lead containing relays as long as the lead containing relay inventory exists.
- Note: Cadmium was exempted from RoHS on October 21, 2005. (Amendment to Directive 2002/95/EC)

### 2. Recommended Lead Free Solder Profile

- Recommended solder paste Sn-3.0Ag-0.5Cu or Sn-3.0 Cu-Ni (only FTR-B3 and FTR-B4 from February 2005).

#### Reflow Solder condition

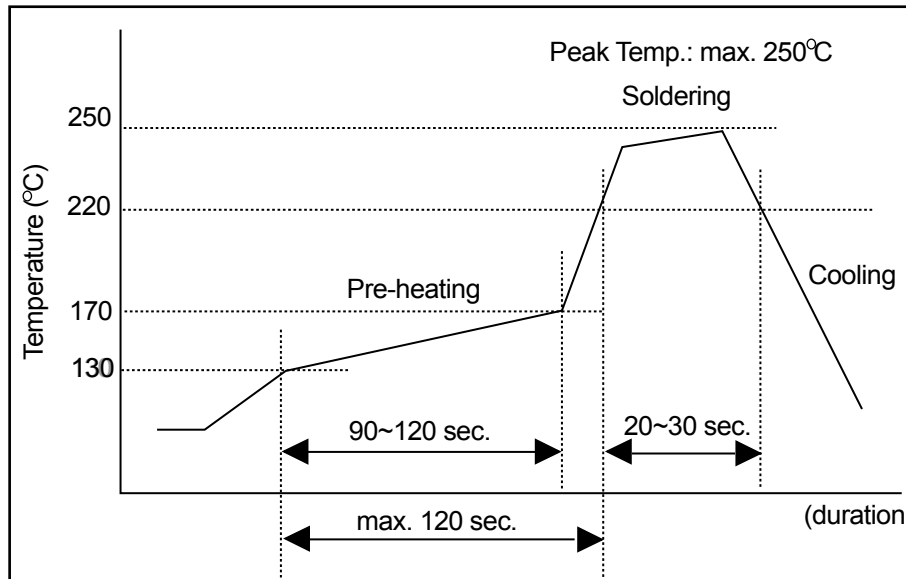

#### Flow Solder condition:

Pre-heating: maximum 120°C  
Soldering: dip within 5 sec. at 260°C solder bath

#### Solder by Soldering Iron:

Soldering Iron  
Temperature: maximum 360°C  
Duration: maximum 3 sec.

We highly recommend that you confirm your actual solder conditions

### 3. Moisture Sensitivity

- Moisture Sensitivity Level is not applicable to electromechanical relays.

### 4. Tin Whisker

- SnAgCu and SnCuNi solder are known as low risk of tin whisker. No considerable whisker length was found by our in-house test.

## Fujitsu Components International Headquarter Offices

### Japan

Fujitsu Component Limited  
Gotanda-Chuo Building  
3-5, Higashigotanda 2-chome, Shinagawa-ku  
Tokyo 141, Japan  
Tel: (81-3) 5449-7010  
Fax: (81-3) 5449-2626  
Email: [promothq@ft.ed.fujitsu.com](mailto:promothq@ft.ed.fujitsu.com)  
Web: [www.fcl.fujitsu.com](http://www.fcl.fujitsu.com)

### North and South America

Fujitsu Components America, Inc.  
250 E. Caribbean Drive  
Sunnyvale, CA 94089 U.S.A.  
Tel: (1-408) 745-4900  
Fax: (1-408) 745-4970  
Email: [components@us.fujitsu.com](mailto:components@us.fujitsu.com)  
Web: <http://us.fujitsu.com/relays/>

### Europe

Fujitsu Components Europe B.V.  
Diamantlaan 25  
2132 WV Hoofddorp  
Netherlands  
Tel: (31-23) 5560910  
Fax: (31-23) 5560950  
Email: [info@fceu.fujitsu.com](mailto:info@fceu.fujitsu.com)  
Web: [emea.fujitsu.com/components/](http://emea.fujitsu.com/components/)

### Asia Pacific

Fujitsu Components Asia Ltd.  
102E Pasir Panjang Road  
#01-01 Citilink Warehouse Complex  
Singapore 118529  
Tel: (65) 6375-8560  
Fax: (65) 6273-3021  
Email: [fcac@fcac.fujitsu.com](mailto:fcac@fcac.fujitsu.com)  
Web: <http://www.fujitsu.com/sg/services/micro/components/>

©2009 Fujitsu Components America, Inc. All rights reserved. All trademarks or registered trademarks are the property of their respective owners.

Fujitsu Components America or its affiliates do not warrant that the content of datasheet is error free. In a continuing effort to improve our products Fujitsu Components America, Inc. or its affiliates reserve the right to change specifications/datasheets without prior notice.  
Rev. March 5, 2009.