



HESTORE.HU

elektronikai alkatrész áruház

EN: This Datasheet is presented by the manufacturer.

Please visit our website for pricing and availability at www.hestore.hu.



OF-SMD5060RGB



Features:

- Extremely wide viewing angle
- Suitable for all SMT assembly and solder process
- Available on tape and reel
- Moisture sensitivity level: Level 4
- Package: 1000pcs/reel
- RoHS compliant



Description:

The Green source color devices are made with InGaN on Substrate Light Emitting Diode

The Blue source color devices are made with InGaN on Substrate Light Emitting Diode

The Red source color devices are made with AlGaInP on

Applications:

- Optical indicator
- Indoor display
- Interior automotive lighting
- Backlight for LCD, switch and Symbol, display
- Light pipe application
- General use



Package Dimensions

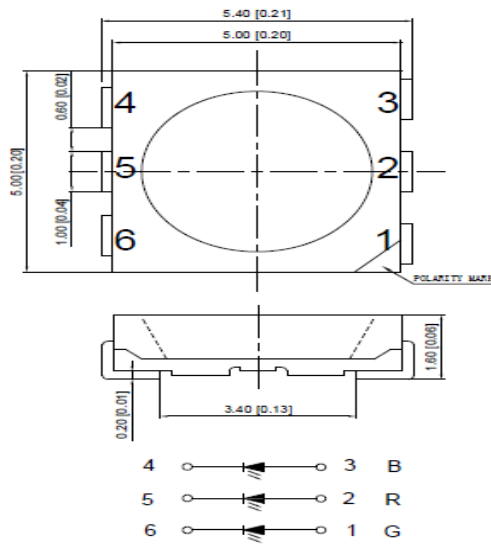

Recommended Soldering Pattern

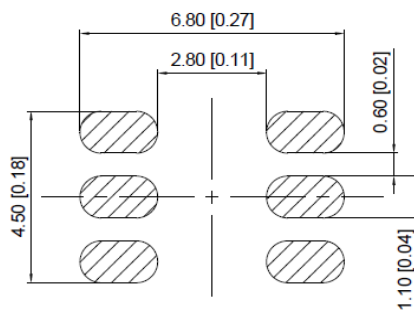

Notes:

1. All dimension units are millimeters.
2. All dimension tolerance is ± 0.15 mm unless otherwise



Selection Guide

Part No.	Dice	Lens Type	Luminous intensity(mcd) @ 20mA		Viewing Angle
			Min.	TYP	2θ1/2
OF-SMD5060RGB	Red(AIGalnP)	Water Clear	276	400	120°
	Blue(InGaN)	Water Clear	150	200	
	Green(InGaN)	Water Clear	600	800	

Note:

1. $\phi 1/2$ is the angle from optical centerline where the luminous intensity is 1/2 the optical centerline value.
2. the above luminous intensity measurement allowance tolerance $\pm 10\%$.

Electrical / Optical Characteristics at Ta=25°C

Parameter	Symbol	Red			Green			Blue			Units	Test Conditions
		Min.	Typ.	Max	Min.	Typ.	Max	Min.	Typ.	Max		
Forward Voltage	V _F	1.8	--	2.4	2.8	--	3.4	2.8	--	3.4	V	I _F =20mA
Reverse Current	I _R	--	--	10	--	--	10	--	--	10	uA	V _R = 5V
Dominate Wavelength	λ_d	618	--	628	515	--	525	464	--	474	nm	I _F =20mA

Absolute Maximum Ratings at Ta=25°C

Parameter	Symbol	Value (Red)	Value (Green)	Value (Blue)	Units
Power dissipation	P _d	75	105	105	mW
DC Forward Current	I _F	30	30	30	mA
Peak Forward Current [1]	I _{FP}	140	100	100	mA
Reverse Voltage	V _R	5	5	5	V
Electrostatic Discharge (HBM)	ESD	2000	1000	1000	V
Operating Temperature	T _{opr}	-40 ~ +85			°C
Storage Temperature	T _{stg}	-40 ~ +100			°C

Note:

1. 1/10 Duty Cycle, 0.1ms Pulse Width.
2. The above forward voltage measurement allowance tolerance $\pm 0.1V$



Typical optical characteristics curves:

Ambient Temperature VS. Forward Current

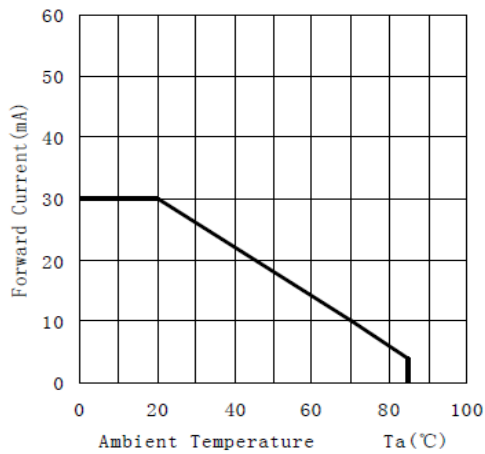

Forward Current VS. Relative Intensity

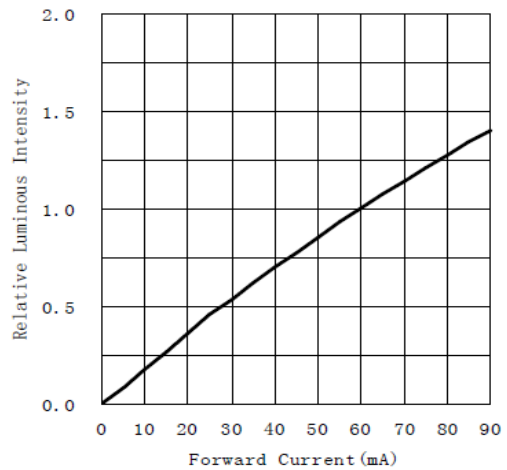

Forward Voltage VS. Forward Current

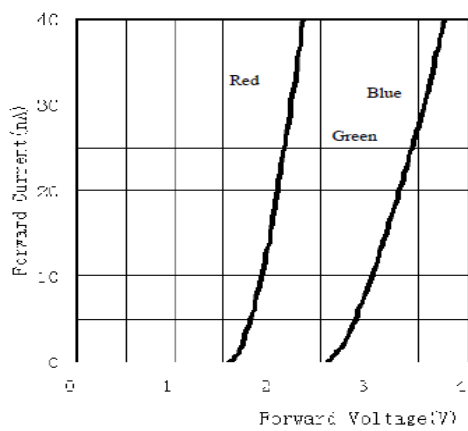

Ambient Temperature VS. Relative Intensity

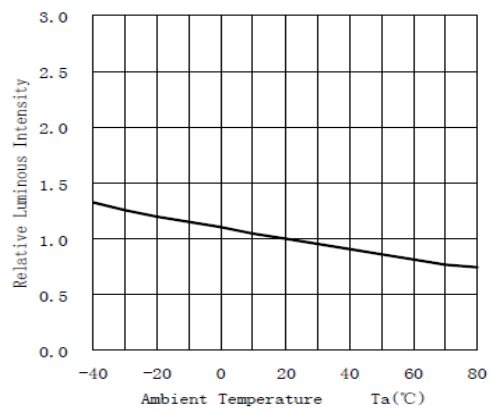

Relative spectral emission

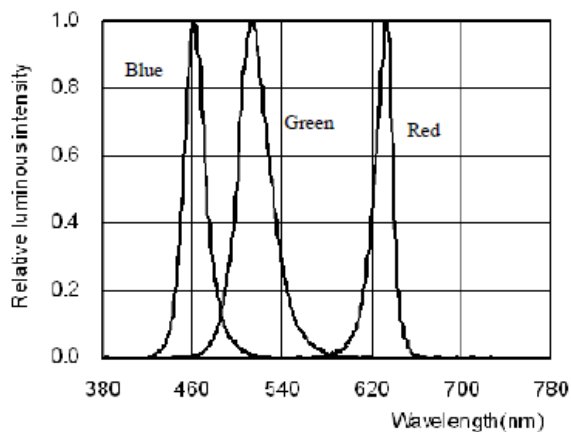
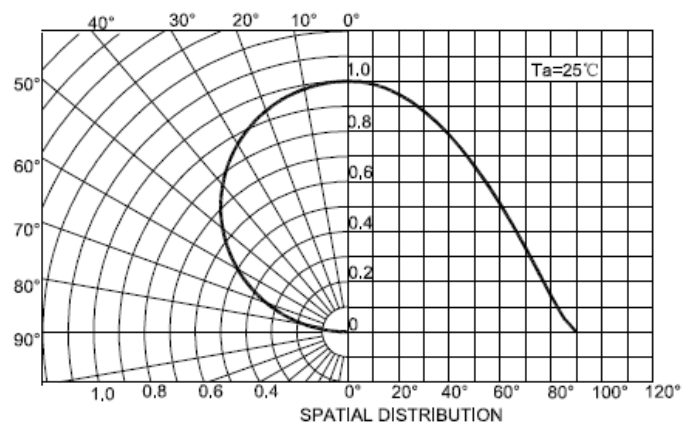

Diagram characteristics of radiation





Reliability Test Items And Conditions:

The reliability of products shall be satisfied with items listed below.

Confidence level :90%

LTPD :10%

No.	Items	Ref.Standard	Test Condition	Test Hours/ Cycles	Sample Size	Ac/Re
1	Reflow	JESD22-B106	Temp:260°Cmax T=10 sec	3 times.	22Pcs.	0/1
2	Temperature Cycle	JESD22-A104	100°C±5°C 30 min. ↑↓5 min -40°C±5°C 30 min.	100 Cycles	22Pcs.	0/1
3	Thermal Shock	JESD22-A106	100°C±5°C 5 min. ↑↓ -40°C±5°C 5 min.	100 Cycles	22Pcs.	0/1
4	High Temperature Storage	JESD22-A103	Temp:100°C±5°C	1000Hrs.	22Pcs.	0/1
5	Low Temperature Storage	JESD22-A119	Temp:-40°C±5°C	1000Hrs.	22Pcs.	0/1
6	DC Operating Life	JESD22-A108	Ta=25°C±5°C IF=20mA*3	1000Hrs.	22Pcs.	0/1
7	High Temperature High Humidity	JESD22-A101	85°C±5°C/ 85%RH IF=5mA*3	1000Hrs.	22Pcs.	0/1

*The technical information shown in the data sheets are limited to the typical characteristics and circuit examples of the referenced products. It does not constitute the warranting of industrial property nor the granting of any license.



SMT Reflow Soldering Instructions:

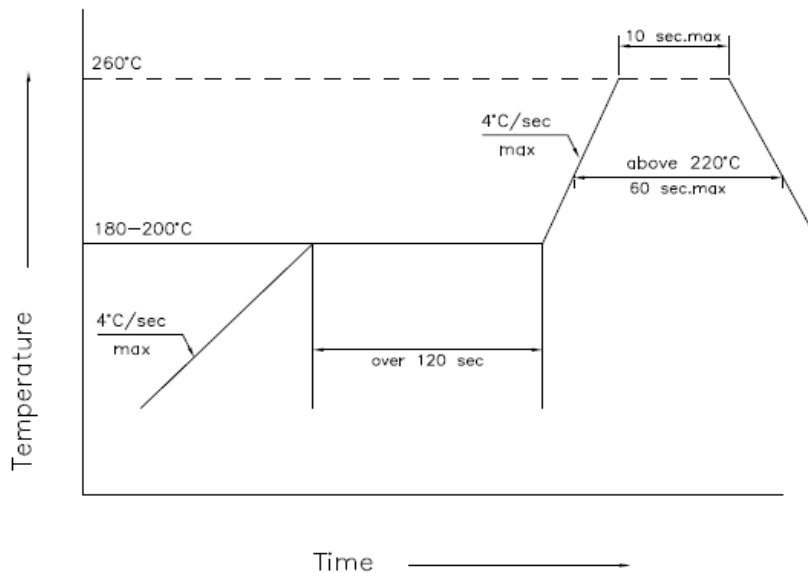

- 1.Reflow soldering should not be done more than two times OF-SMD5060RGB
- 2.When soldering , do not put stress on the LEDs during heating

Soldering iron:

- 1.When hand soldering, the temperature of the iron must less than 300°C for 3 seconds
- 2.The hand solder should be done only one times

Repairing:

Repair should not be done after the LEDs have been soldered. When repairing is unavoidable, a double-head soldering iron should be used (as below figure). It should be confirmed beforehand whether the characteristics of LEDs will or will not be damaged by repairing.

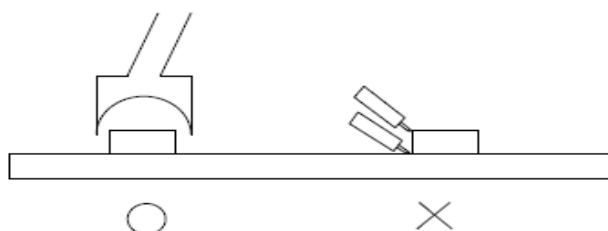



Handling Precautions:

Compare to epoxy encapsulant that is hard and brittle, silicone is softer and flexible. Although its characteristic significantly reduces thermal stress, it is more susceptible to damage by external mechanical force. As a result, Special handling precautions need to be observed during assemble using silicone encapsulated LED products, Failure to comply might leads to damage and premature failure of the LED.

1.Handle the component along the side surface by using forceps or appropriate tools

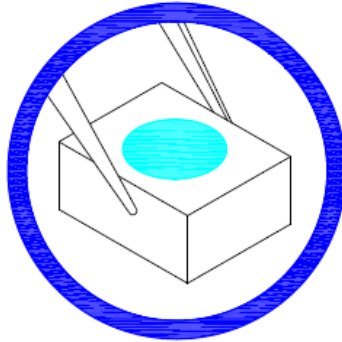

2.Do not directly touch or handle the silicone lens surface. It may damage the internal circuitry

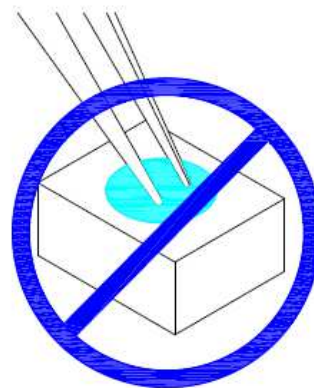
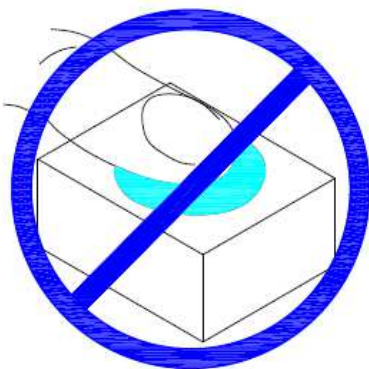



3. Do not stack together assembled PCBs containing LEDs. Impact may scratch the silicone lens or damage the internal circuitry

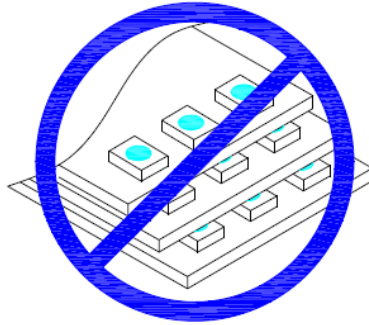

4. Not available in the situation of acidity for PH



5. LED operating environment and sulfur element composition cannot be over 100PPM in the LED mating usage material

Label

IV: Luminous intensity rank

λ D: Dominate Wavelength

VF: Forward voltage rank

RoHS		
Part No:	XXXXXXXXXXXXXXXXXXXXXX	
IV:	VF:	WD:
Quantity:		
Sealing date:	XXXXXXXXXXXXXXXXXXXXXX	
		



Tape Specifications (Units : mm)

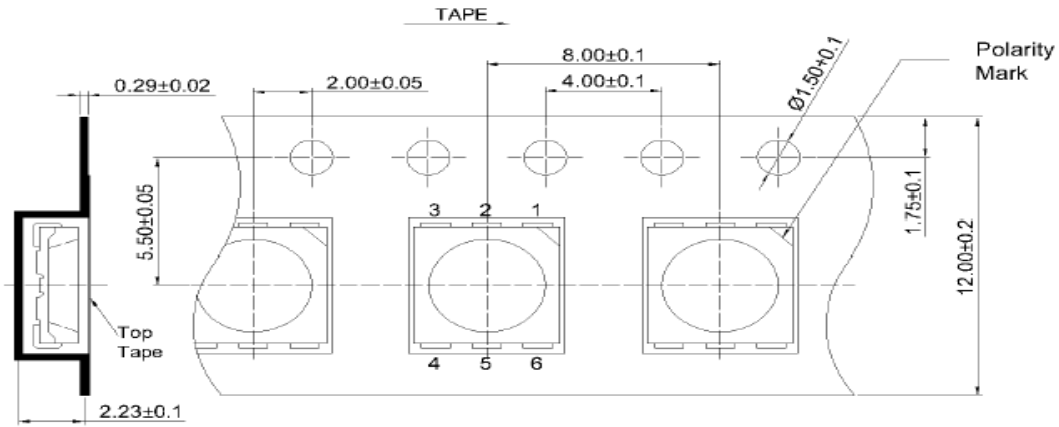

Reel Dimensions

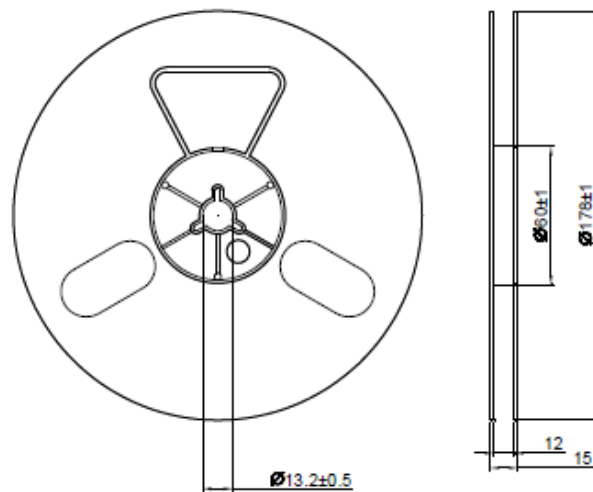

Moisture Resistant Packaging

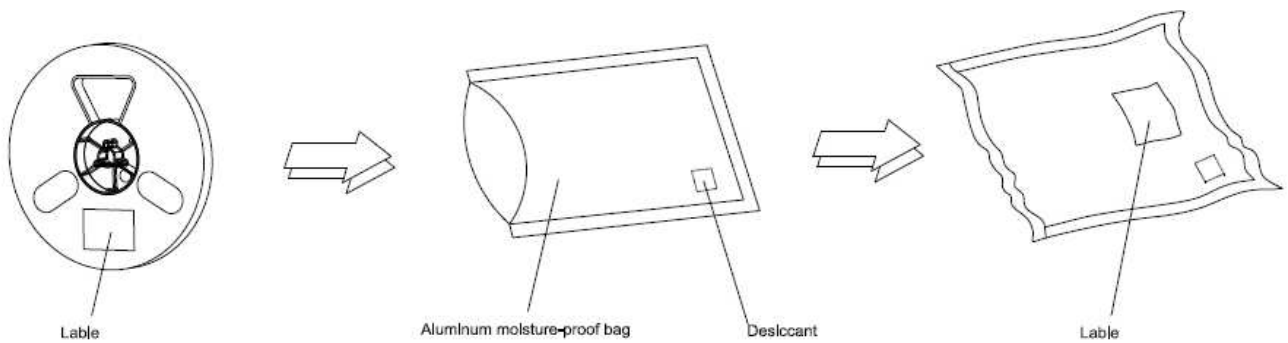

Note: The tolerances unless mentioned is ± 0.1 mm , Unit: mm

