



**HESTORE.HU**

elektronikai alkatrész áruház

**EN:** This Datasheet is presented by the manufacturer.

Please visit our website for pricing and availability at [www.hestore.hu](http://www.hestore.hu).

# RM699B



## miniature relays

version (V)



version (H)



- Cover width only 5 mm
- Sealed for soldering and cleaning
- **Terminals arrangement: vertical version (V) and horizontal version (H)**
- Applications: for PLC's, industrial machinery, time relays, counters, temperature adjusters, measurement instruments, office equipment, etc.
- Recognitions, certifications, directives: RoHS,   

### Contact data

Number and type of contacts	1 CO, 1 NO	
Contact material	<b>AgSnO<sub>2</sub></b> , AgNi	AgSnO <sub>2</sub> /Au hard gold plating ① AgNi/Au hard gold plating ①
Max. switching voltage	400 V AC / 250 V DC	
Min. switching voltage	10 V	
Rated load (capacity)	AC1	6 A / 250 V AC
	AC15	3 A / 120 V; 1,5 A / 240 V (B300)
	DC1	6 A / 30 V DC; 0,15 A / 250 V DC
	DC13	0,22 A / 120 V; 0,1 A / 250 V (R300)
Motor load	acc. to UL 508	1/4 HP 240 V AC ②
	AC3 acc. to IEC 60947-4-1	0,186 kW 240 V AC ②
Min. switching current	100 mA	
Max. inrush current	10 A 20 ms	
Rated current	6 A	
Max. breaking capacity	AC1	1 500 VA
Min. breaking capacity	1 W	
Contact resistance	≤ 100 mΩ 100 mA, 24 V	
Max. operating frequency	AC1	• at rated load
		• no load
		360 cycles/hour
		72 000 cycles/hour

### Coil data

Rated voltage	DC	5, 6, 9, 12, 24, 48, 60 V
Must release voltage	DC: ≥ 0,05 U <sub>n</sub>	
Range of supply voltage	see Table 1	
Rated power consumption	DC	0,17 W 5 ... 24 V      0,21 W 48, 60 V

### Insulation according to EN 60664-1

Insulation rated voltage	250 V AC	
Rated surge voltage	6 000 V 1,2 / 50 μs	
Overvoltage category	III	
Dielectric strength	• between coil and contacts	4 000 V AC      type of insulation: reinforced
	• contact clearance	1 000 V AC      type of clearance: micro-disconnection
Contact - coil distance	• clearance	≥ 6 mm
	• creepage	≥ 8 mm

### General data

Operating / release time (typical values)	8 ms / 4 ms	
Electrical life (number of cycles)	• resistive AC1	the NO and NC contact loaded (bilateral load): see Fig. 1 the NO contact loaded: > 3 x 10 <sup>4</sup> 6 A, 250 V AC
	• inductive AC3	6 x 10 <sup>3</sup> 186 W (single-phase motor), AgNi
Mechanical life (cycles)	> 10 <sup>7</sup>	
Dimensions (L x W x H)	28 x 5 x 15 mm	
Weight	5 g	
Ambient temperature	• storage	-40...+85 °C
	• operating	-40...+85 °C
Cover protection category	IP 67	EN 60529
Environmental protection	RTIII	EN 61810-7
Relative humidity	5...85%	
Shock resistance	5 g	
Vibration resistance	5 g 10...55 Hz	
Solder bath temperature	max. 260 °C	
Soldering time	max. 5 s	

The data in bold type relate to the standard versions of the relays. ① For gold-plated contacts - when the maximum values given have been exceeded, the gold layer is destroyed. Then, the advantages of gold-plating disappear and the values are as for AgSnO<sub>2</sub>, AgNi contacts (see beside), and electrical life of these contacts may be shorter than of normal contacts. ② Contact 1 NO, single-phase motor.

# RM699B

miniature relays

## Dimensions

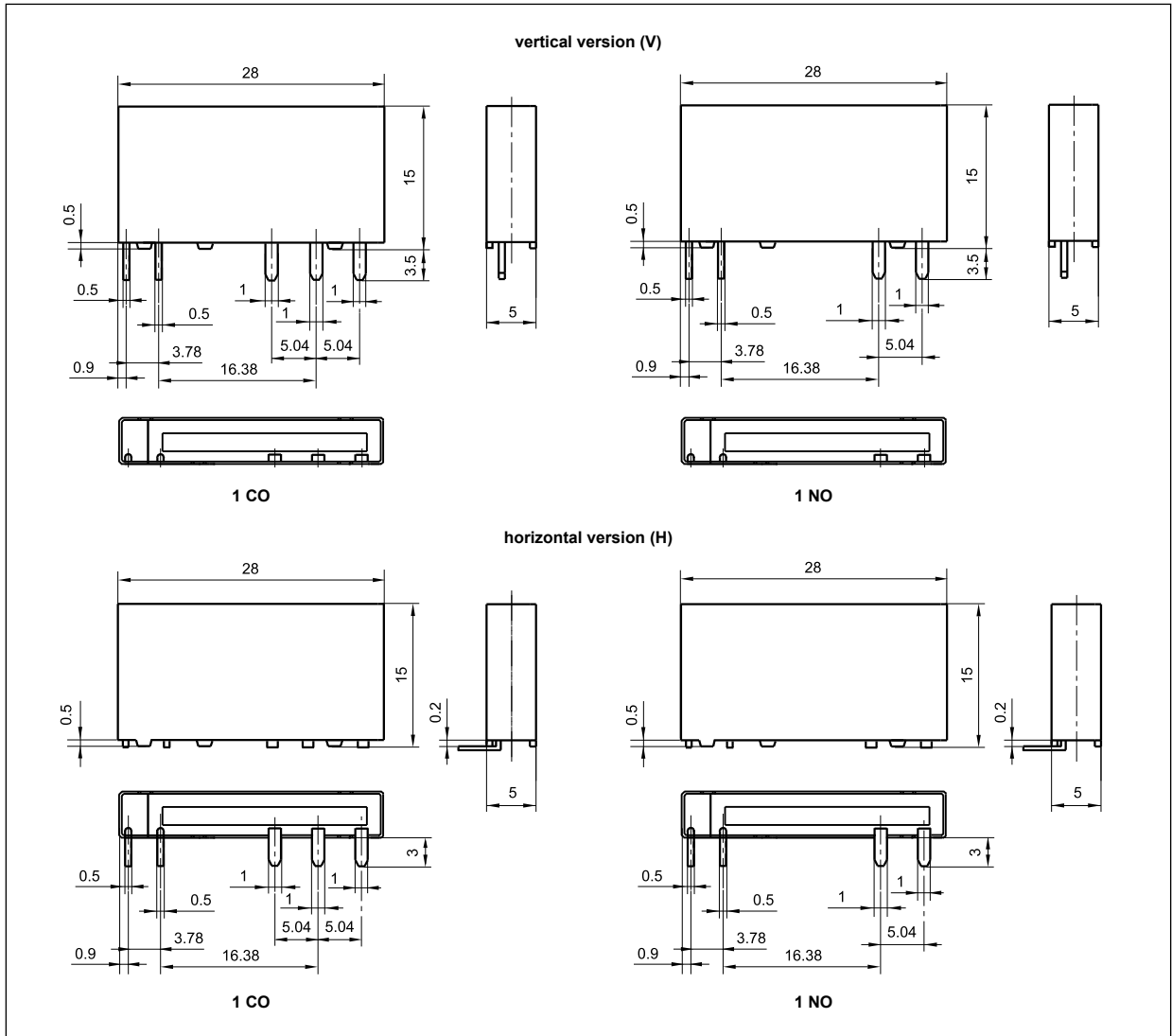

## Pinout (solder side view)

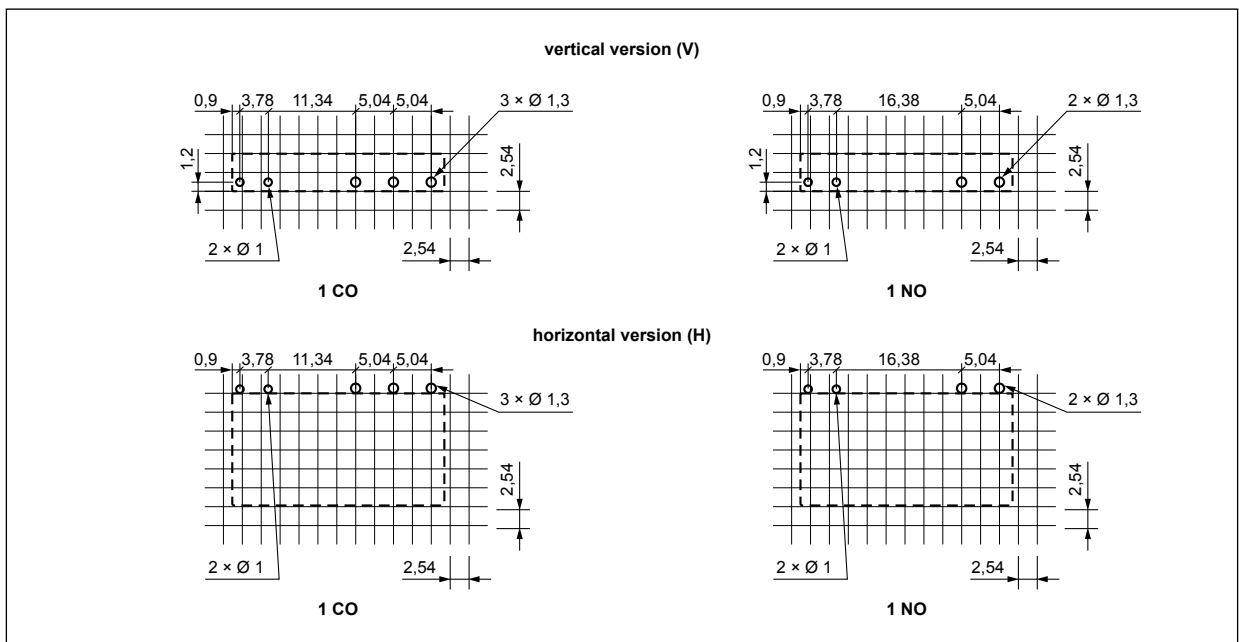

## Connection diagrams (pin side view)

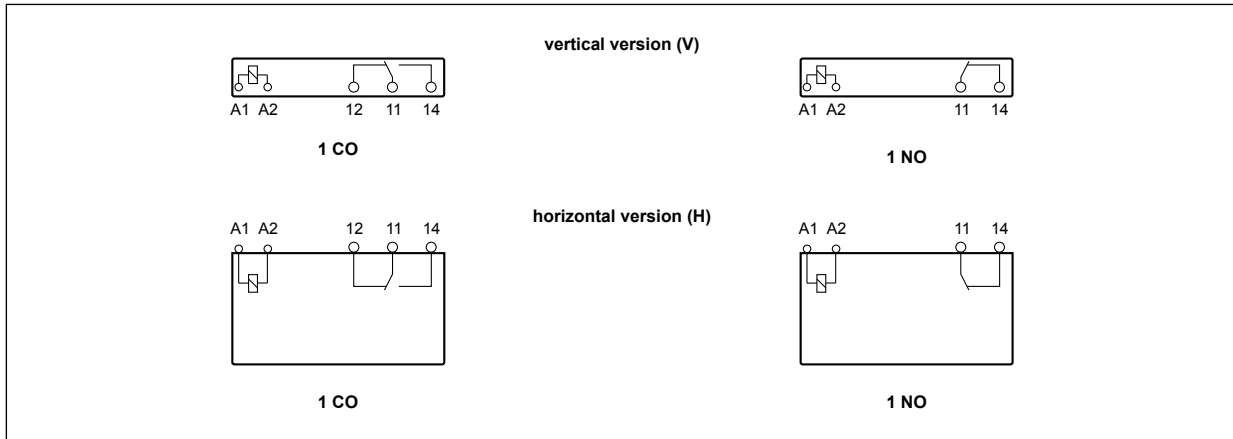

**Electrical life at AC resistive current.**  
Switching frequency: 360 cycles/hour

Fig. 1

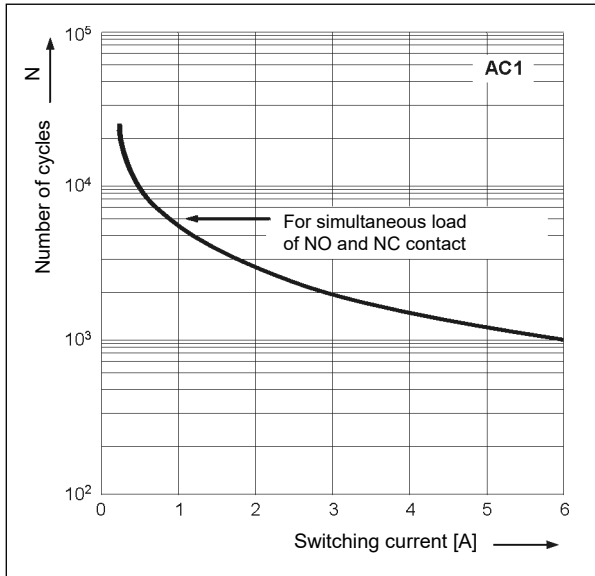

**Max. DC resistive load breaking capacity**

Fig. 2

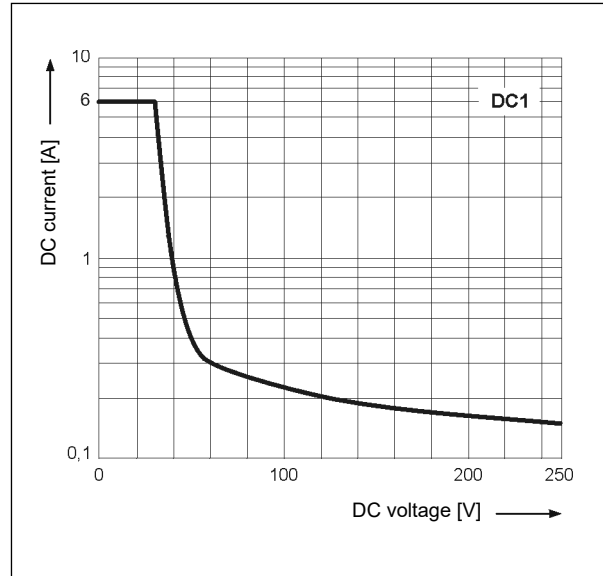

## Mounting

Relays **RM699B horizontal version (H)** are designed for direct PCB mounting.

Relays **RM699B vertical version (V)** are designed for: • direct PCB mounting • plug-in sockets.

Sockets for RM699BV	Accessories		
	Description plates	Interconnection strips	Separators
<b>Screw terminals sockets, 35 mm rail mount (EN 60715)</b>			
PI6W ⑤	PI6W-1246	ZG20 ⑥	—
6W ⑤	MP6-C ④	JB20 ⑥	6W-SEP
<b>Spring terminals sockets, 35 mm rail mount (EN 60715)</b>			
PI6WB ⑤	PI6W-1246	ZG20 ⑥	—
6WB ⑤	MP6-C ④	JB20 ⑥	6W-SEP
<b>Sockets for PCB</b>			
GD699	MP6-C ④	—	—

⑤ Sockets with electronic PI6W., 6W.: version codes and selection of relays for sockets can be found in the data sheets of interface relays PIR6W., SIR6W. - see [www.repol.com.pl](http://www.repol.com.pl) ④ Cards MP6-C: for automatic printing, containing 64 description plates. ⑥ Colours of strips: ZG20-1, JB20-1 red; ZG20-2, JB20-2 black; ZG20-3, JB20-3 blue.

# RM699B

## miniature relays

Coil data - DC voltage version

Table 1

Coil code	Rated voltage V DC	Coil resistance at 20 °C Ω	Acceptable resistance	Coil range V DC ⑥	
				min. (at 20 °C)	max. (at 20 °C)
1005	5	147	± 10%	3,75	7,5
1006	6	212	± 10%	4,5	9,0
1009	9	476	± 10%	6,75	13,0
1012	12	848	± 10%	9,0	18,0
1024	24	3 390	± 15%	18,0	36,0
1048	48 ⑦	10 600	± 15%	36,0	72,0
1060	60 ⑦	16 600	± 15%	45,0	90,0

⑥ The maximum value of the supply voltage is the value that may occur on the coil of the relay for a short while. Permanent supply of RM699B relay with the maximum voltage may damage the relay coil. ⑦ For relays with the rated voltage of coils 48 V DC and 60 V DC, it is necessary to stabilize the supply voltage at the level of the rated voltage in order to protect the coils of relays from damage.

### Ordering codes

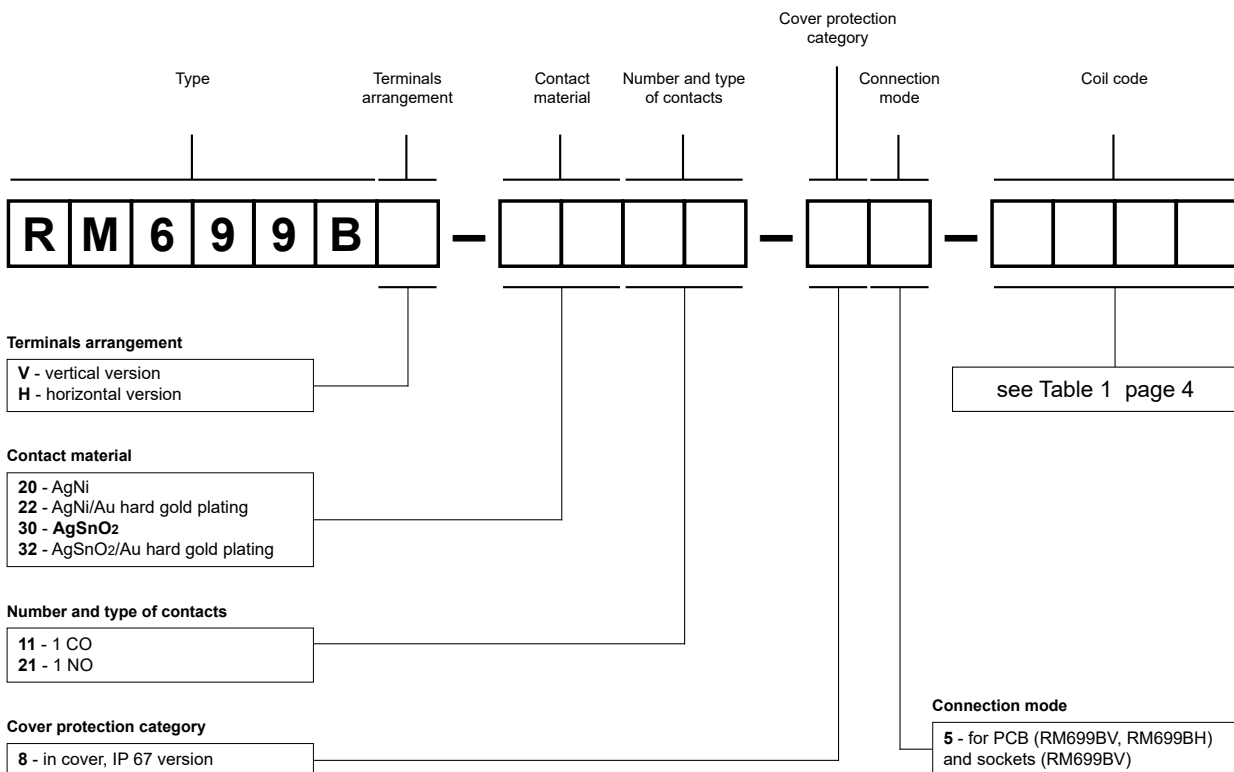

Examples of ordering code:

**RM699BV-3011-85-1012**

relay **RM699B**, vertical version, for PCB and sockets, one changeover contact, contact material AgSnO<sub>2</sub>, coil voltage 12 V DC, in cover IP 67

**RM699BH-2021-85-1005**

relay **RM699B**, horizontal version, for PCB, one normally open contact, contact material AgNi, coil voltage 5 V DC, in cover IP 67

# Sockets and accessories

## PI6W-1P ①

For RM699BV, RSR30 ③

Screw terminals  
Max. tightening moment  
for the terminal: 0,3 Nm  
35 mm rail mount  
acc. to EN 60715  
98,5 x 6,2 x 85,5 mm  
One pole  
6 A, 250 V AC

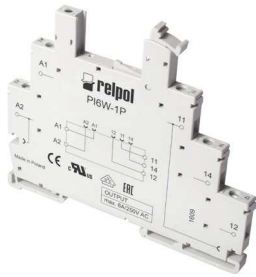

### Connection diagram

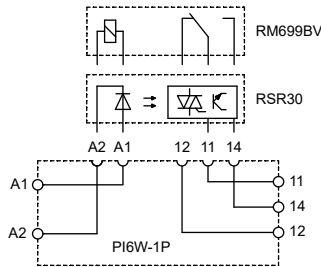

### Dimensions

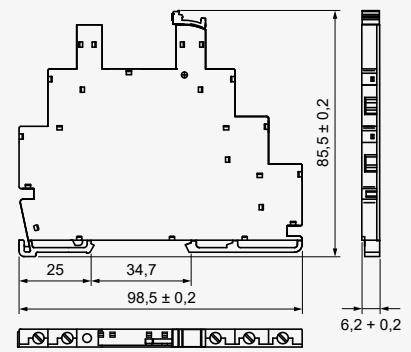

### Accessories ④

## PI6W-1P ②

For RM699BV

Screw terminals  
Max. tightening moment  
for the terminal: 0,3 Nm  
35 mm rail mount  
acc. to EN 60715  
98,5 x 6,2 x 85,5 mm  
One pole  
6 A, 250 V AC



### Connection diagram

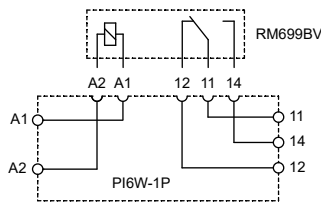

### Dimensions

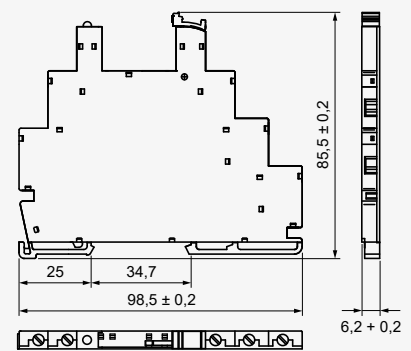

### Accessories ④

## PI6W-1PS ②

For RM699BV, RSR30 ③

Screw terminals  
Max. tightening moment  
for the terminal: 0,3 Nm  
35 mm rail mount  
acc. to EN 60715  
98,5 x 6,2 x 85,5 mm  
One pole  
6 A, 250 V AC

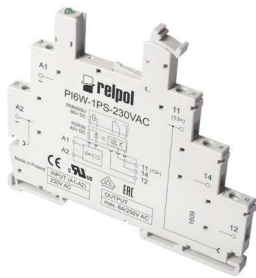

### Connection diagram

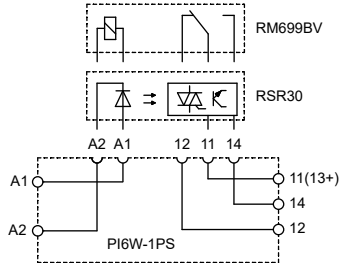

### Dimensions

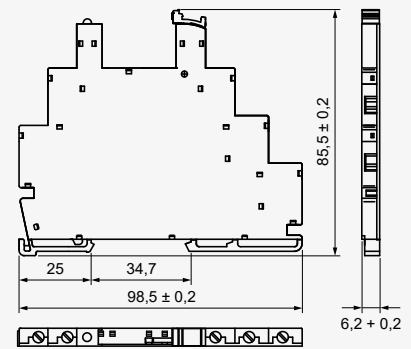

### Accessories ④

## PI6WB-1PS ②

For RM699BV, RSR30 ③

Spring terminals  
35 mm rail mount  
acc. to EN 60715  
98,3 x 6,2 x 84,6 mm  
One pole  
6 A, 250 V AC



### Connection diagram

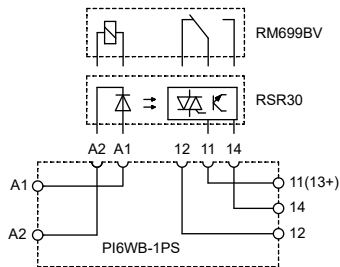

### Dimensions

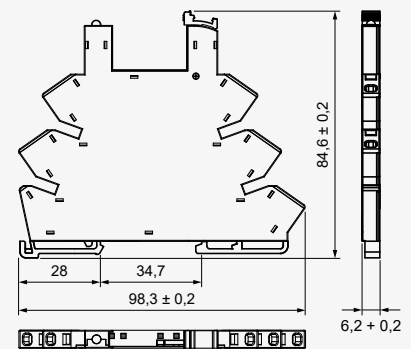

### Accessories ④

① Sockets without electronic. ② Sockets with electronic PI6W., 6W.: version codes and selection of relays for sockets can be found in the data sheets of interface relays PIR6W., SIR6W. - see [www.repol.com.pl](http://www.repol.com.pl) ③ Solid state relays RSR30 - see [www.repol.com.pl](http://www.repol.com.pl) ④ Colours of strips: ZG20-1, JB20-1 red; ZG20-2, JB20-2 black; ZG20-3, JB20-3 blue.

# Sockets and accessories

## 6W <sup>2</sup>

For RM699BV, RSR30 <sup>3</sup>

Screw terminals; Max. cross section of the cables:  
 1 x 2,5 mm<sup>2</sup> / 2 x 1,5 mm<sup>2</sup>  
 Stripping length: 7 mm  
 Max. tightening moment for the terminal: 0,5 Nm

35 mm rail mount acc. to EN 60715  
 88,6 x 6,2 x 76 mm  
 One pole  
 6 A, 250 V AC

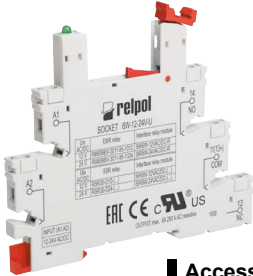

### Accessories <sup>4</sup>

### Connection diagram

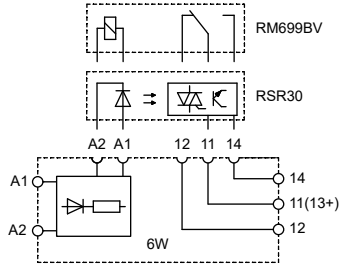

MP6-C

JB20



6W-SEP

### Dimensions

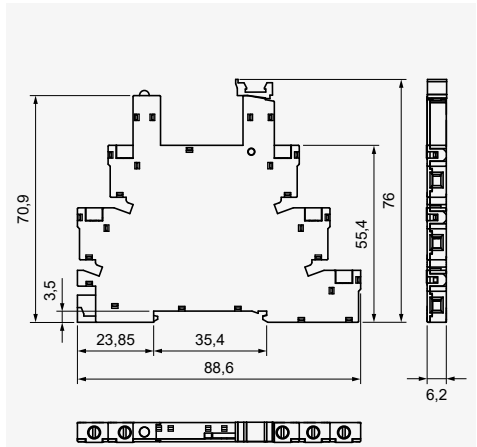

## 6WB <sup>2</sup>

For RM699BV, RSR30 <sup>3</sup>

Spring terminals  
 Max. cross section of the cables: 1 x 2,5 mm<sup>2</sup>  
 Stripping length: 7 mm

35 mm rail mount acc. to EN 60715  
 95 x 6,2 x 76,6 mm  
 One pole  
 6 A, 250 V AC

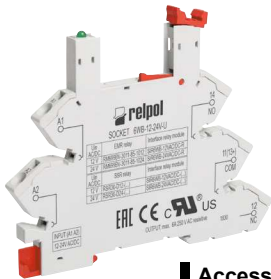

### Accessories <sup>4</sup>

### Connection diagram

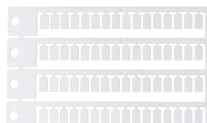
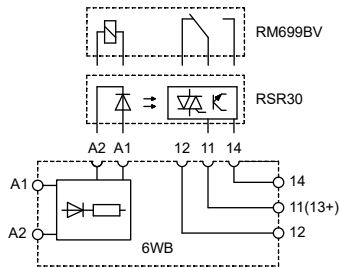

MP6-C

JB20



6W-SEP

### Dimensions

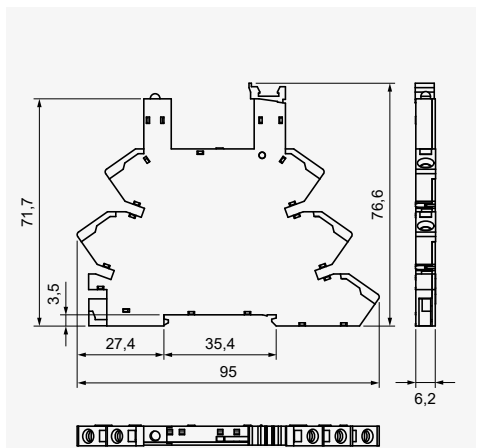

<sup>2</sup> Sockets with electronic PI6W., 6W.: version codes and selection of relays for sockets can be found in the data sheets of interface relays PIR6W., SIR6W. - see [www.repol.com.pl](http://www.repol.com.pl) <sup>3</sup> Solid state relays **RSR30** - see [www.repol.com.pl](http://www.repol.com.pl) <sup>4</sup> Colours of strips: ZG20-1, JB20-1 red; ZG20-2, JB20-2 black; ZG20-3, JB20-3 blue.

# Sockets and accessories

## GD699

For RM699BV, RSR30

For PCB  
33 x 6 x 37,21 mm  
One pole, 5 mm pinout  
6 A, 250 V AC



## Rozstaw otworów w obwodzie drukowanym

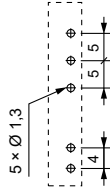

## Accessories

MP6-C

## Dimensions

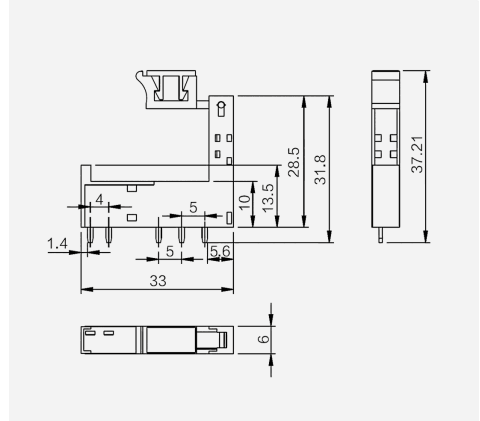

Ⓢ Solid state relays **RSR30** - see [www.repol.com.pl](http://www.repol.com.pl)

## Mounting and sub-assemblies of the relay and accessories in the socket

Solid state relay

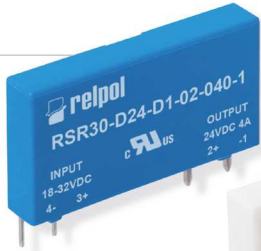

Electromagnetic relay



Plug-in socket for PCB



Description plate

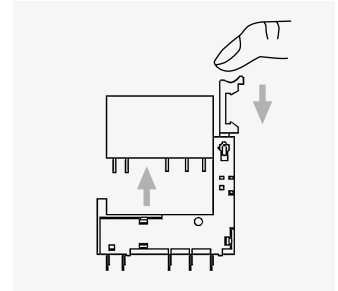

Removing the relay from the socket with a retractor / retractor clip

### PRECAUTIONS:

1. Ensure that the parameters of the product described in its specification provide a safety margin for the appropriate operation of the device or system and never use the product in circumstances which exceed the parameters of the product. 2. Never touch any live parts of the device. 3. Ensure that the product has been connected correctly. An incorrect connection may cause malfunction, excessive heating or risk of fire. 4. In case of any risk of any serious material loss or death or injuries of humans or animals, the devices or systems shall be designed so to equip them with double safety system to guarantee their reliable operation.