



**HESTORE.HU**

elektronikai alkatrész áruház

**EN:** This Datasheet is presented by the manufacturer.

Please visit our website for pricing and availability at [www.hestore.hu](http://www.hestore.hu).

IEC Appliance Inlet C6, insert Mounting, Front or Rear Side, Solder, PCB or Quick-connect Terminal



Frontside



from rear side



See below:

**Approvals and Compliances**

**Description**

- Drop-in type
- Appliance Inlet , Pin temperature 70 °C Protection class I
- Solder / Quick Connect / PCB Terminal

**Characteristics**

- Contact pins are turned from solid material

**Weblinks**

[pdf data sheet](#), [html datasheet](#), [General Product Information](#), [Approvals](#), [Distributor-Stock-Check](#), [Accessories](#), [Detailed request for product](#)

**Technical Data**

Ratings IEC	2.5 A / 250VAC; 50Hz	Appliance inlet/-outlet	C6 acc. to IEC 60320-1
Ratings UL/CSA	7 A / 125VAC; 60Hz		UL 60320-1, CSA C22.2 no. 60320-1-11 (for cold conditions) pin-temperature 70 °C, 2.5A, Protection Class I
Dielectric Strength	> 4 kVAC between L-N > 2 kVAC between L/N-PE (1 min/50Hz)		
Allowable Operation Temperature	-25 °C to 70 °C		
IP-Protection	front side IP20 acc. to IEC 60529		
Protection against electric shock	Suitable for appliances with protection class I acc. to IEC 61140		
Material: Housing	PA6, black, UL 94V-0		

**Approvals and Compliances**

Detailed information on product approvals, code requirements, usage instructions and detailed test conditions can be looked up in [Details about Approvals](#)

SCHURTER products are designed for use in industrial environments. They have approvals from independent testing bodies according to national and international standards. Products with specific characteristics and requirements such as required in the automotive sector according to IATF 16949, medical technology according to ISO 13485 or in the aerospace industry can be offered exclusively with customer-specific, individual agreements by SCHURTER.

**Approvals**

The approval mark is used by the testing authorities to certify compliance with the safety requirements placed on electronic products.

Approval Reference Type: 2563

Approval Logo	Certificates	Certification Body	Description
	<a href="#">VDE Approvals</a>	VDE	VDE Certificate Number: 40002273
	<a href="#">UL Approvals</a>	UL	UR File Number: E96454

**Product standards**

Product standards that are referenced

Organization	Design	Standard	Description
	Designed according to	IEC 60320-1	Appliance couplers for household and similar general purposes
	Designed according to	UL 60320-1	Standard for Attachment Plugs and Receptacles
	Designed according to	CSA C22.2 no. 60320-1-11	General Use Receptacles, Attachment Plugs, and Similar Wiring Devices





**Application standards**

Application standards where the product can be used

Organization	Design	Standard	Description
	Suitable for applications acc.	IEC/UL 62368-1	Audio/video, information and communication technology equipment - Part 1: Safety requirements

**Compliances**

The product complies with following Guide Lines

Identification	Details	Initiator	Description
	<a href="#">CE declaration of conformity</a>	SCHURTER AG	The CE marking declares that the product complies with the applicable requirements laid down in the harmonisation of Community legislation on its affixing in accordance with EU Regulation 765/2008.
	<a href="#">UKCA declaration of conformity</a>	SCHURTER AG	The UKCA marking declares that the product complies with the applicable requirements laid down in the British Amendment of Regulation (EC) 765/2008.
	RoHS	SCHURTER AG	Directive RoHS 2011/65/EU, Amendment (EU) 2015/863
	China RoHS	SCHURTER AG	The law SJ / T 11363-2006 (China RoHS) has been in force since 1 March 2007. It is similar to the EU directive RoHS.
	REACH	SCHURTER AG	On 1 June 2007, Regulation (EC) No 1907/2006 on the Registration, Evaluation, Authorization and Restriction of Chemicals 1 (abbreviated as "REACH") entered into force.

**Dimensions [mm]**

Solder/quick connect terminals

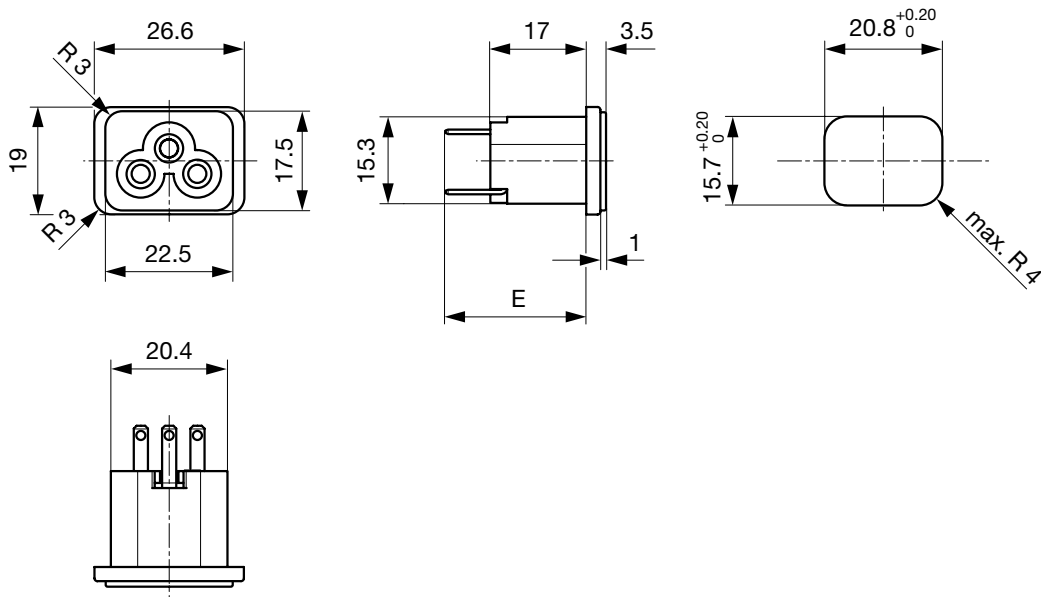

- E: Solder terminals short: 18.9 mm
- E: Solder terminals long: 22.6 mm
- E: Quick connect terminals 2.8x0.8 mm: 24.9 mm

PCB

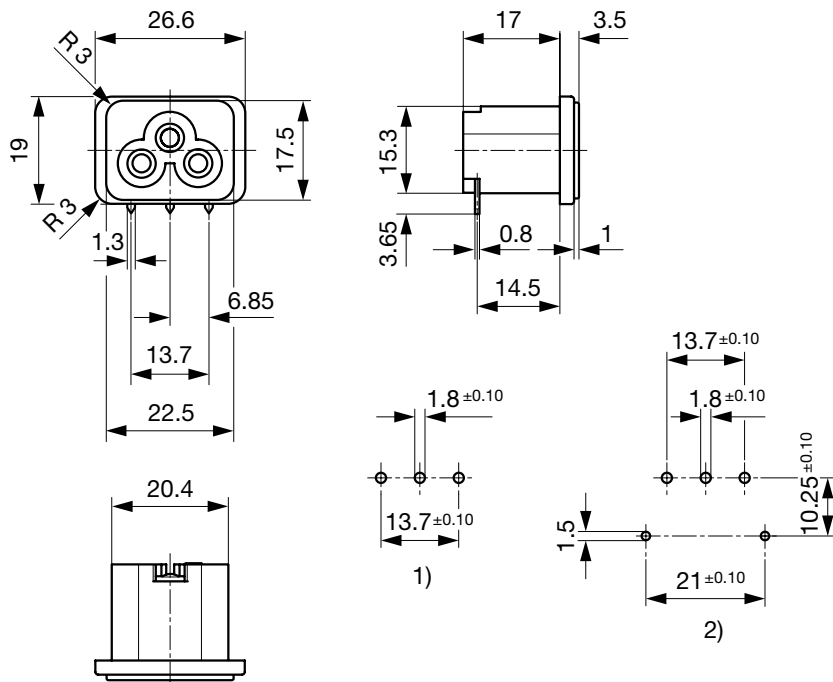

- 1) without retaining bracket
- 2) with retaining bracket

## Order number key

2	5	6	3	-	X	-	4	4	4	0	-	A	-	5	00
					1		2	3	4		5			6	7

**Version**  1

Application inlet C6 = X

**Terminal L**  2

Solder, L= 4.8mm = 2

PCB = 4

Quick connect 2.8x0.8 = 7

**Terminal N**  3

Solder, L= 4.8mm = 2

PCB = 4

Quick connect 2.8x0.8 = 7

**Terminal PE**  4

Solder, L= 4.8mm = 2

PCB = 4

Quick connect 2.8x0.8 = 7

**Colour**  5

black = A

**Mounting**  6

Insert = 5

**Customer spec. Types**  7

Standard = 00

## Variants

Terminals L / N	Terminal Ground	Config. Code	Order Number
PCB-terminal standard (additional solder terminal)	PCB-terminal standard (additional solder terminal)	2563-X-4440-A-500	6160.0003

The listed variants should be available from stock. Other versions on request [www.schurter.com/contact](https://www.schurter.com/contact)Availability for all products can be searched real-time: <https://www.schurter.com/en/info-center/support-tools/stock-check-distributors>

## Packaging unit

100 Pcs