



**HESTORE.HU**

elektronikai alkatrész áruház

**EN:** This Datasheet is presented by the manufacturer.

Please visit our website for pricing and availability at [www.hestore.hu](http://www.hestore.hu).

## Common Dimensions

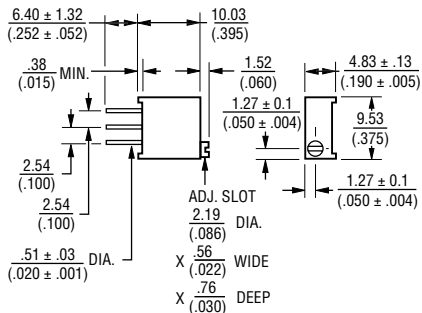

## 3296P

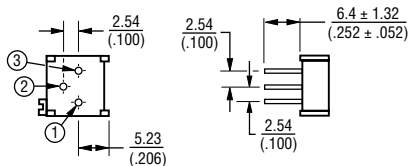

## 3296W

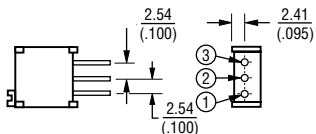

## 3296X

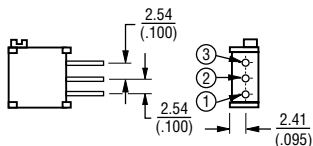

## 3296Y

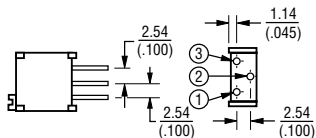

## 3296Z

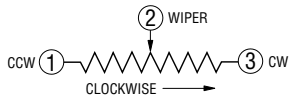
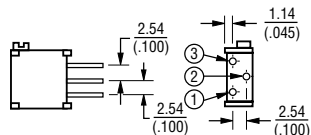

DIMENSIONS:  $\frac{\text{MM}}{(\text{INCHES})}$

TOLERANCES:  $\pm \frac{0.25}{(.010)}$  EXCEPT WHERE NOTED