



HESTORE.HU

elektronikai alkatrész áruház

EN: This Datasheet is presented by the manufacturer.

Please visit our website for pricing and availability at www.hestore.hu.

SPECIFICATION

- Electrical Rating: bakelite: 10A 250V AC (Resistive Load)
ceramic: 16A 250V AC (Resistive Load)
- Operating Temp: 50 ~ 175°C (UL CUL 205 °C)
- Differential: 10~30K (15K Standard)
- Temp. Tolerance: Operating Temp. 3±K 5±K
- Heat Durability: 220°C Max. (PPS)
- Circuit Resistance: 50mΩ Max.
- Insulation Resistance: 100MΩ Min. at DC500V
- Dielectric Strength: AC 1000V for One Minute.
or AC 1800V for One Second.
- Operating Life: 100000 Cycles (16A 125V/10A 250V AC)
10000 Cycles (16A 250V AC)



HOW TO ORDER

MODEL CODE (FULL CODE)

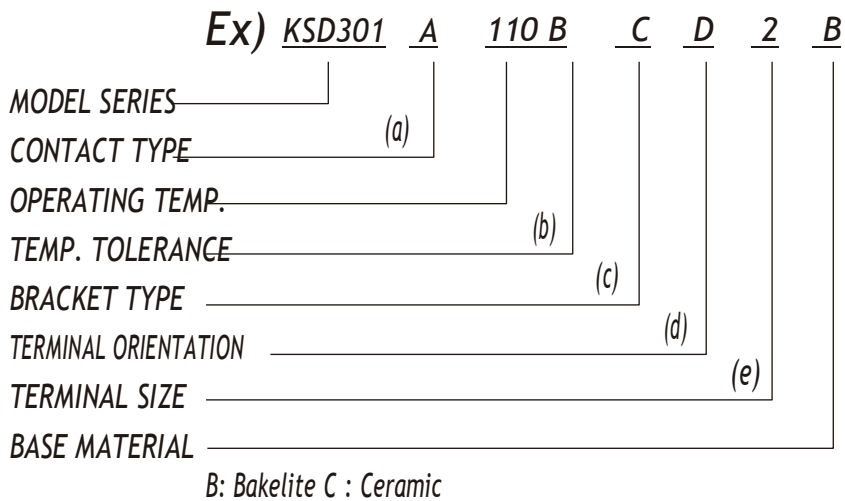

(a) CONTACT TYPE :

A = Contact Opens When Temperature Rises to Set Point (Normally Closed)



B = Contact Closes When Temperature Rises to Set Point (Normally Open)



M = Manual Reset

(b) TEMP. TOLERANCE :

(*=STANDARD)

Grade	A	*B
Action ± °C	3	5
Reset ± °C	4	8

- The Grade of Temp. Tolerance is "A", When The Operating Temp. is Less Than 105°C.

- The Grade of Temp. Tolerance is "B", When The Operating Temp. is Over 106°C.

(c) BRACKET TYPE :

● FIXED BRACKET

* STAINLESS STEEL CAP : D,DL,V,T TYPE

SCREW TYPE : M4x0.7 L:6mm (STD)
M5x0.8 L:6mm (STD)
#6-32UNC
#8-32UNC

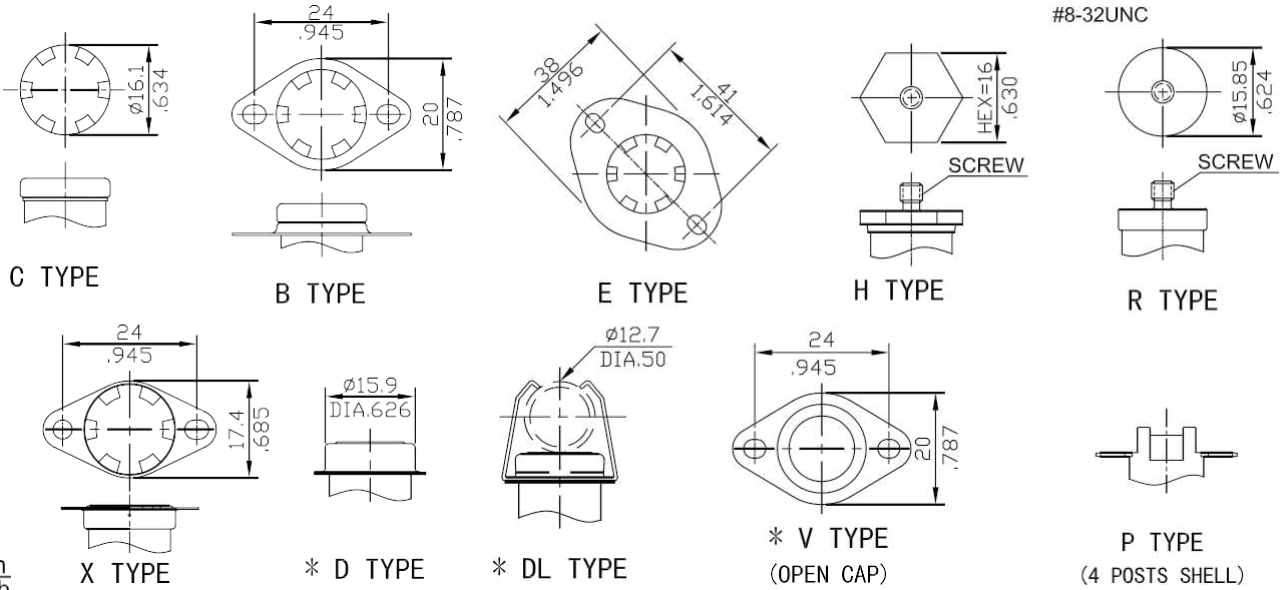

● LOOSE BRACKET

* STAINLESS STEEL CAP : U TYPE

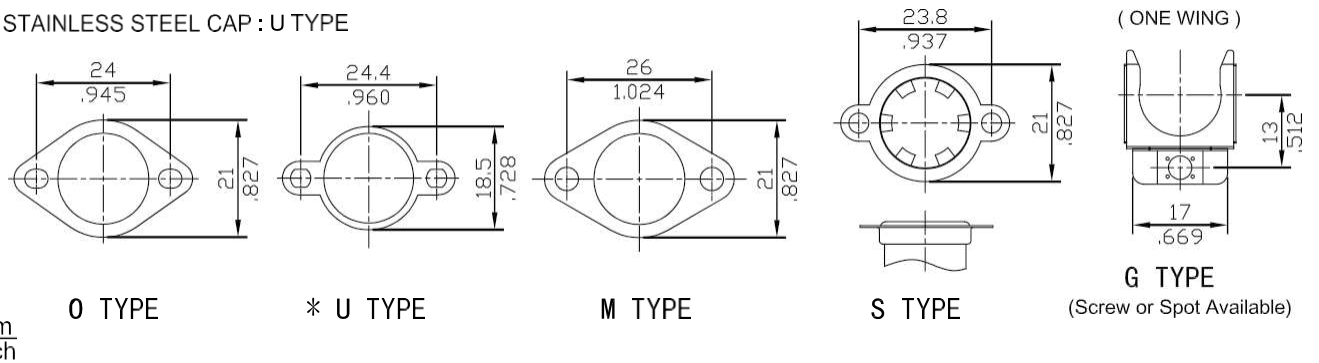

(d) TERMINAL ORIENTATION:

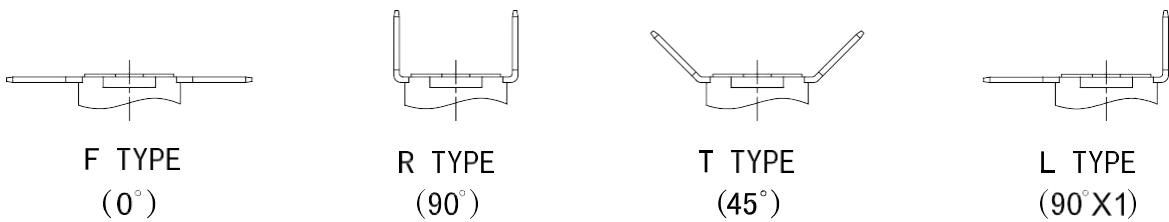

(e) TERMINAL SIZE:

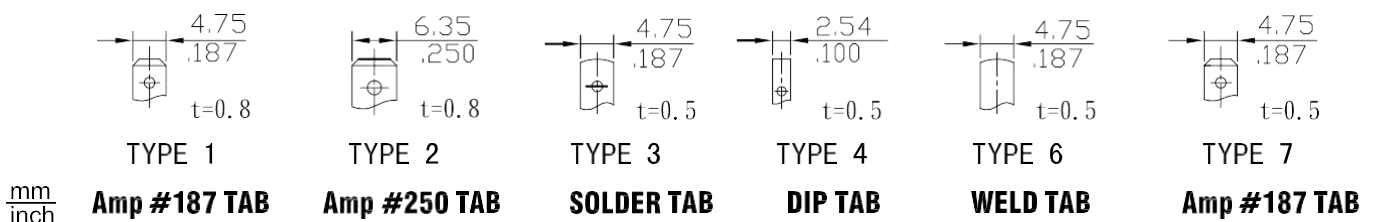

KSD301A-CF2

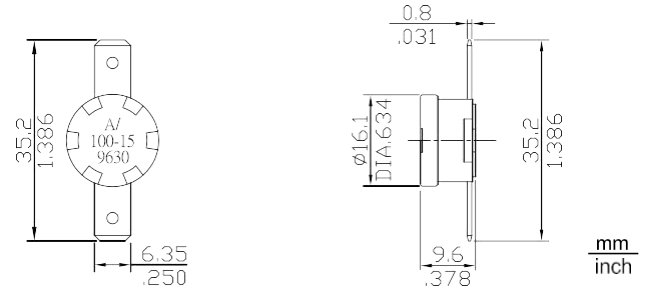

KSD301A-CR1-OS(ONE SHOT)

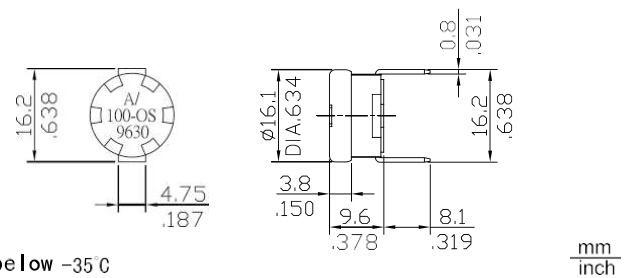

Reset below -35°C

KSD301A-SF2(LOOSE BRACKET)

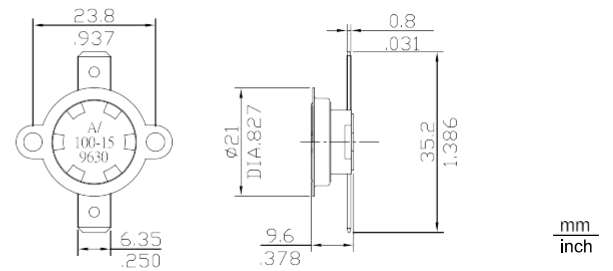

KSD301A-PF2(4-POST)

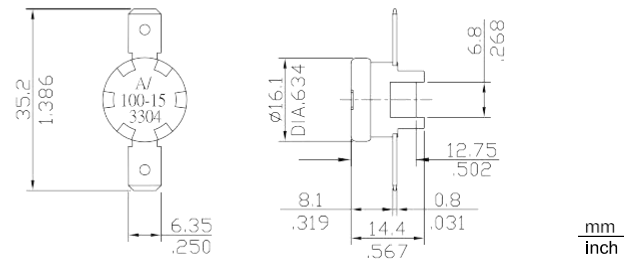

KSD301A-XF2(FIX BRACKET)

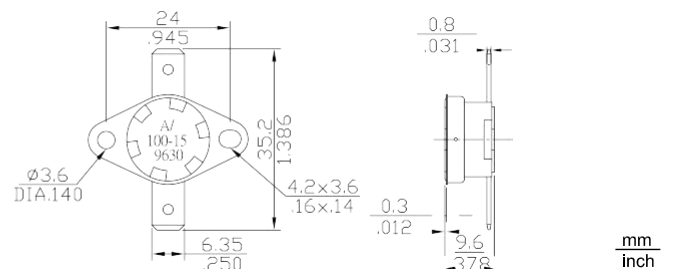

Thermostat KSD301



KSD301M-RF2

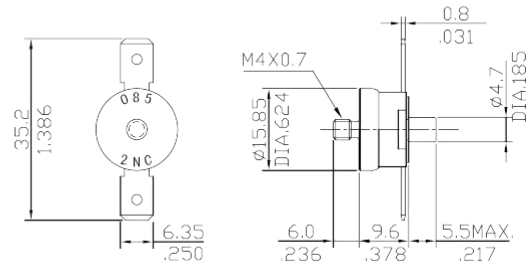

mm
inch

KSD301A-HF1

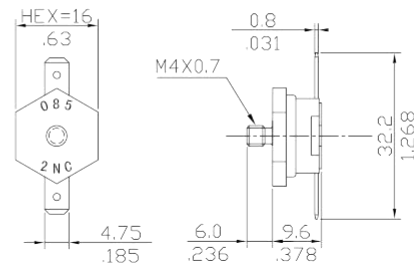

mm
inch

KSD301A-HR1

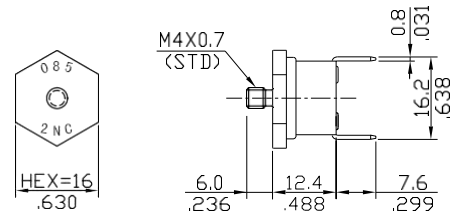

mm
inch

KSD301A-RF2-A

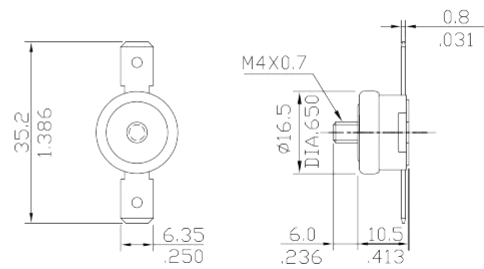

mm
inch

KSD301A-RF2-A

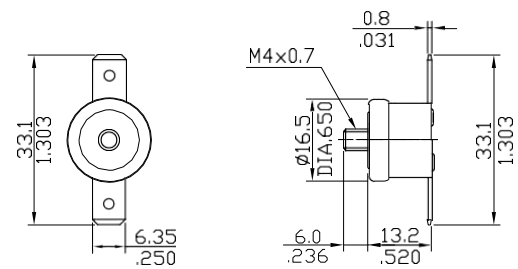

mm
inch

KSD301A-BF2

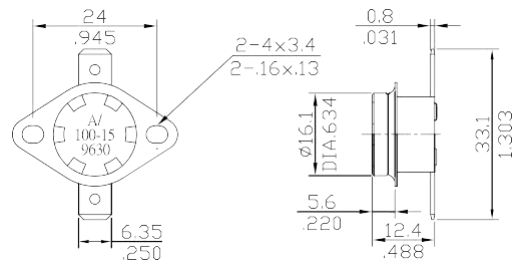

mm
inch

KSD301B-CF2

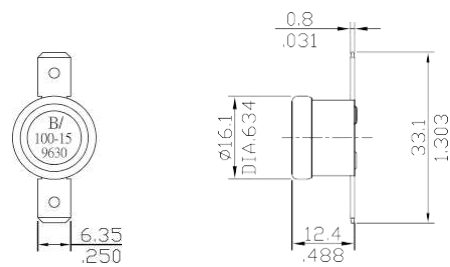

mm
inch

KSD301M-DF2

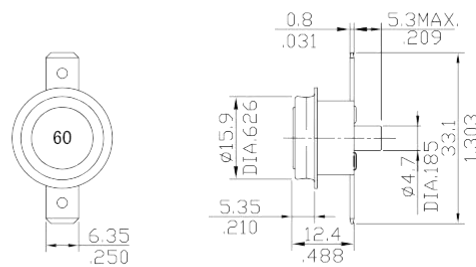

mm
inch

KSD301A-CR4



(FOR PCB)

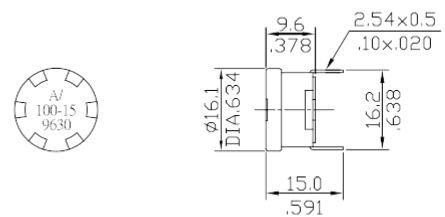

mm
inch

KSD301A-DR2-E

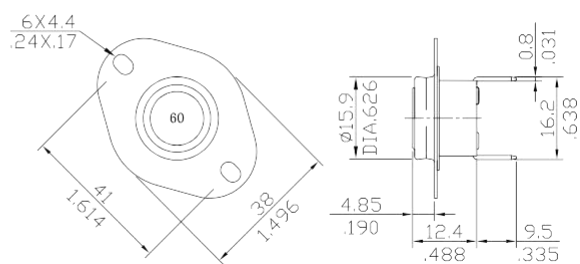

mm
inch

Thermostat KSD301



KSD301A-SF2-U

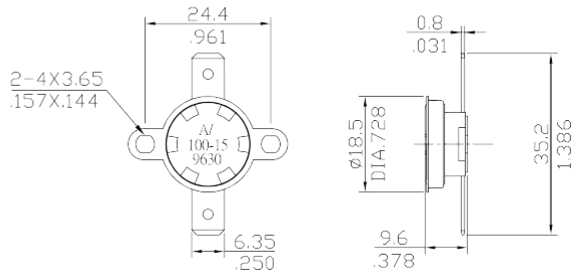

mm
inch

KSD301A-SF2(LOOSE BRACKET)

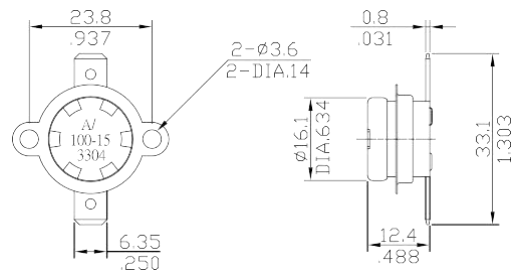

mm
inch

KSD301A-XF1(FIX BRACKET)

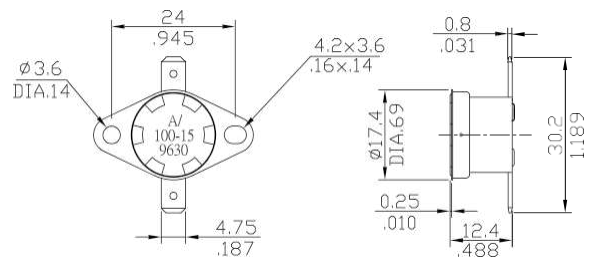

mm
inch

KSD301A-BF2-V(OPEN CAP)

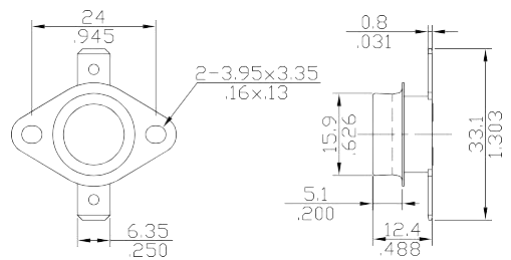

mm
inch