



HESTORE.HU

elektronikai alkatrész áruház

EN: This Datasheet is presented by the manufacturer.

Please visit our website for pricing and availability at www.hestore.hu.

Lead Type Disc High Voltage Ceramic Capacitors-HV Series (500VDC-6.3KVDC) Data Sheet

Feature

- Wide capacitance range from 100pF to 100000pF
- Operating Temperature: $-25^{\circ}\text{C} \sim 85^{\circ}\text{C}$
- Storage Temperature: $15^{\circ}\text{C} \sim 35^{\circ}\text{C}$
- The high voltage disc ceramic capacitors have feature of withstanding higher voltage

Applications

- These capacitors are used in bypass and coupling circuit, and those capacitors with low dissipation factor are particularly suitable to be used in circuits such as line scanning in Tvset

Part Number Code

N	07	F	1	B	472	M	N0	B	0	S	0	N	0
---	----	---	---	---	-----	---	----	---	---	---	---	---	---

Rated Voltage L: 500VDC N: 1KVDC R: 2KVDC S: 3KVDC T: 4KVDC W: 5KVDC A: 6KVDC	Pitch A:2.5mm B:5.0mm E:7.5mm D:10.0mm	Tolerance C:±0.25pF J±5% :K:±10% M:±20%	Package B: Bulk T:Tape	Inner Management
Core Diameter 04: 4.0mm 05: 5.0mm 16: 16.0mm C0: 5.0mm C4: 5.4mm C6: 5.6mm	Nominal capacitance 10:100pF 100:101pF 222:2200pF 103:10000pF	Environmental Standard 0:RoHS 2:RoHS+Halogen-Free		
Foot Type 1:Long straight 2:Outside Crimped 3:Short Straight 4:Inner Crimped 8:Vertical Crimped	Lead Length S0~S9:1.0~1.9mm X0~X9:2.0~2.9mm A0~A9:3.0~3.9mm B0~B9:4.0~4.9mm C0~C9:5.0~5.9mm D0~D9:6.0~6.9mm E0~E9:7.0~7.9mm	Lead Length F0~F9:8.0~8.9mm G0~G9:9.0~9.9mm H0~H9:10.0~10.9mm J0~J9:11.0~11.9mm K0~K9:12.0~12.9mm L0~L9:13.0~13.9mm M0~M9:14.0~14.9mm	Lead Length M0~M9:14.0~14.9mm N0:16~27.0mm(Bulk) Crimped Lead Taped N0:H0=16.5mm P0:H0=17.0mm Q0:H0=19.0mm Straight Lead Q0:20.0mm	
Temperature Characteristic A:NP0 S:SL B:Y5P E:Y5U F:Y5V				

Specifications

Capacitance and Dissipation factor testing condition	SL/NP0:25℃、1±0.1MHz、1.0Vrms Y5P/Y5U/Y5V:25℃、1±0.1MHz、1.0Vrms
Dissipation Factor(tanδ)	SL/NP0:≤0.15% Y5P/Y5U/Y5V:≤2.5%
Rated Voltage	500VDC、1000VDC、2000VDC、3000VDC、4000VDC、5000VDC、6000VDC
Withstand Voltage	1.5U _R +500V(DC)
Insulation Resistance (I.R.)	SL/NP0:IR≥10000MΩ;Y5P/Y5U/Y5V:IR≥4000MΩ
Temperature Characteristic	SL、NP0、Y5P、Y5U、Y5V

Dimensions (mm)

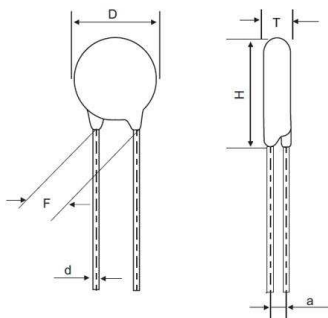

Rated Voltage (VDC)	Temperature Coefficient Group					Dimension (mm)		Lead Size (mm)			
	Y5P (B)	Y5U (E)	Y5V (F)	SL	NP0	D±1	T±1	F	d±0.05		
Nominal Capacitance (pF)											
500	100-1500	1500-2200	3300-4700	20-150	0.5-22	5.5	2.0	5.0±0.8	0.5		
	/	3300-4700	6800	/	/	6.5					
	2200	5600-6800	6800-10000	/	/	7.5					
	3300	10000	/	/	/	9.5					
	4700	/	20000-22000	/	/	10.5	2.5	7.5±0.8	0.6		
	10000	/	/	/	/	14.5					
	/	/	47000	/	/	17.0					
	/	/	100000	/	/	20.0					
1000	100-820	/	/	20-100	0.5-22	5.5	2.5	5.0±0.8	0.5		
	1000	/	/	/	/	6.0					
	/	1500-3300	4700-6800	/	/	6.5					
	1500-1800	4700-5600	/	/	/	7.5					
	2200-2700	/	10000	/	/	8.5					
	/	6800	15000	/	/	9.5					
	3300	10000	/	/	/	10.5					
	4700	/	/	/	/	11.5					
	/	/	20000-22000	/	/	13.0				7.5±0.8	0.6
	/	/	33000	/	/	15.0					
	10000	/	47000	/	/	17.5					
	/	/	100000	/	/	22.5					
2000	100-470	1000	1500-2200	/	/	6.0	2.5/3.0	5.0±0.8	0.5		
	560-820	/	3300	10-120	0.5-10	7.0					
	1000	2200	4700	68	/	8.0					
	1500	4700	6800	/	/	10.0	3.0	7.5±0.8	0.6		
	1800-2200	/	10000	/	/	11.0					
	2700	/	/	/	/	12.0					
	3300	/	/	/	/	13.0					
	2200	/	/	/	/	14.0					
	4700	10000	20000-22000	/	/	14.5					

Rated Voltage (VDC)	Temperature Coefficient Group					Dimension (mm)		Lead Size (mm)	
	Y5P(B)	Y5U(E)	Y5V(F)	SL	NPO	D±1	T±1	F	d±0.05
	Nominal Capacitance (pF)								
3000	100-470	680-1000	1500	27-68	3-22	6.0	3.0/3.5	7.5±0.8	0.6
	270-680	/	2200	/	/	7.0	3.5		
	/	1500	3300	82	/	8.0			
	1000	2200	4700	/	/	9.0			
	/	3300	6800-10000	/	/	11.0		10.0±0.8	0.6/0.7
	/	4700	10000	/	/	13.0			
	/	10000	/	/	/	17.5			
	/	/	20000-22000	/	/	20.5			
3150	100-470	1000	1500	10-39	/	6.0	3.5	7.5±0.8	0.6
	680	/	2200	47-68	/	7.0			
	/	1500	3300	82	/	8.0			
	1000	2200	4700	/	/	9.0			
	1500	3200	/	/	/	11.0	10.0±0.8	0.7	
	2200	4700	/	/	/	13.0			
	/	/	10000	/	/	14.0			
	/	10000	/	/	/	17.5			
4000	100-470	680-1000	1500	10-68	3-22	6.0	3.0/3.5	7.5±0.8	0.6
	270-680	/	2200	/	/	7.0	3.5		
	/	1500	3300	82	/	8.0			
	1000	2200	4700	/	/	9.0			
	/	3300	6800-10000	/	/	11.0		10.0±0.8	0.6/0.7
	/	4700	10000	/	/	13.0			
	/	10000	/	/	/	17.5			
	/	/	20000-22000	/	/	20.5			
5000	100-220	330-470	1000	10-39	/	6.0	3.5/4.5	10.0±0.8	0.6/0.7
	330	560-1000	1500	47-56	/	7.0	4.5		
	470	/	2200	68-82	/	8.0			
	560-680	1500	/	/	/	9.0			
	/	2200	3300	/	/	10.0		13.5	16.5
	1000	/	4700	/	/	11.0			
	/	3300	/	/	/	13.5			
	/	4700	/	/	/	16.5			

Rated Voltage (VDC)	Temperature Coefficient Group					Dimension (mm)		Lead Size (mm)	
	Y5P(B)	Y5U(E)	Y5V(F)	SL	NPO	D±1	T±1	F	d±0.05
Nominal Capacitance (pF)									
6000	100-220	330-470	1000	10-39	/	6.0	3.5/4.5	10.0 ±0.8	0.6/0.7
	330	560-1000	1500	47-56	/	7.0	4.5		
	470	/	2200	68-82	/	8.0			
	560-680	1500	/	/	/	9.0			
	/	2200	3300	/	/	10.0			
	1000	/	4700	/	/	11.0			
	/	3300	/	/	/	13.5			
	/	4700	/	/	/	16.5			
6300	100-220	1000	/	10-39	/	6.0	3.5/4.5	10.0 ±0.8	0.6/0.7
	330	/	/	47-68	/	7.0	4.5		
	470	/	2200	82	/	8.0			
	680	/	/	/	/	9.0			
	1000	2200	3300	/	/	10.0			
	/	/	4700	/	/	11.0			

Lead Configuration

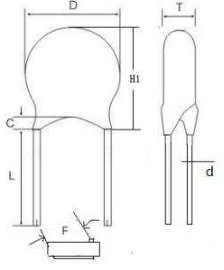
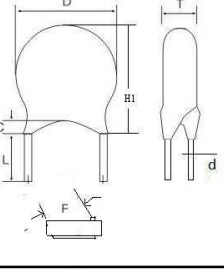
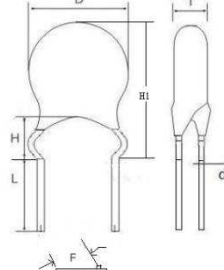
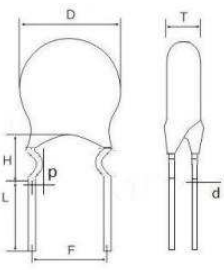
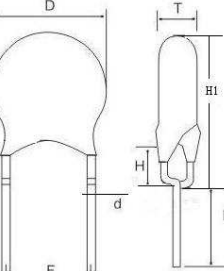
Lead Style	Drawing	Lead Length L (mm)	Coating Lead Length C (mm)
Long Straight		16.0 min	① C ≤ 2.5mm (Product diameter < 12mm) ② C ≤ 3.0mm (Product diameter ≥ 12mm)
Short Straight		① [2.5 ≤ L < 6.0] ± 0.5; ② [6.0 ≤ L ≤ 10] ± 1.0	① C ≤ 2.5mm (Product diameter < 12mm) ② C ≤ 3.0mm (Product diameter ≥ 12mm)
Outside Crimped		① [2.5 ≤ L < 6.0] ± 0.5; ② [6.0 ≤ L ≤ 10] ± 1.0	Not exceed the bend point
Inner Crimped		① [2.5 ≤ L < 6.0] ± 0.5; ② [6.0 ≤ L ≤ 10] ± 1.0	Not exceed the bend point
Vertical Crimped		① [2.5 ≤ L < 6.0] ± 0.5; ② [6.0 ≤ L ≤ 10] ± 1.0	Not exceed the bend point

Taping And Dimensions (mm)

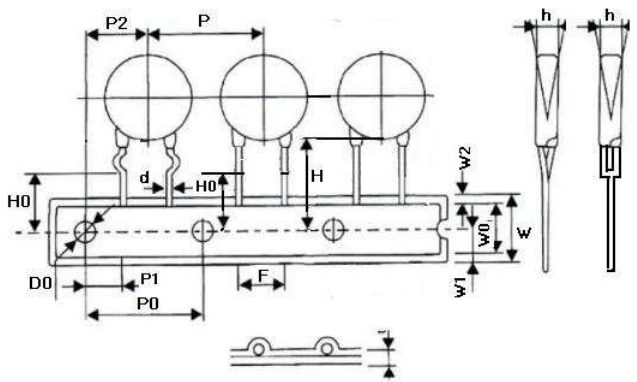
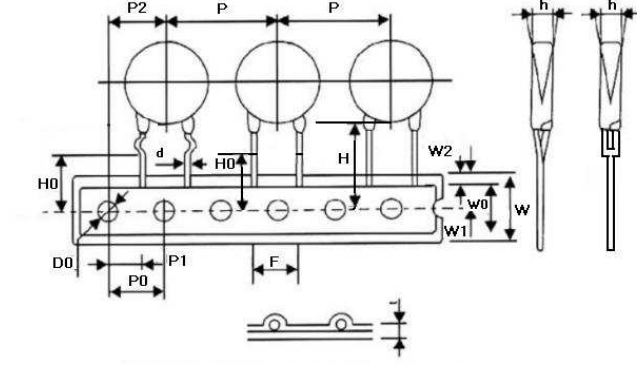
Figure	Fig.1		Fig.2				
	Symbol	P=5.0	P=7.5		P=10.0		
	Po	12.7±0.3	12.7±0.3	12.7±0.3			
	P	12.7±1.0	25.4±1.0	25.4±1.0			
	P1	3.85±0.7	8.95±0.7	7.7±0.7			
	P2	6.35±1.3	12.7±1.3	12.7±1.3			
	F	5±0.8	7.5±0.8	10.0±0.8			
	Δh	0±2.0	0±2.0	0±2.0			
	W	18.0+1.5/-1.0	18.0 +1.5/-1.0	18.0 +1.5/-1.0			
	Wo	10.5 Max	10.5 Max	10.5 Max			
	W1	9.0+0.75/-0.5	9.0+0.75/-0.5	9.0+0.75/-0.5			
	W2	3.0 Max	3.0 Max	3.0 Max			
	Do	4.0±0.2	4.0±0.2	4.0±0.2			
	H	20+1.5/-1.0	20+1.5/-1.0	20+1.5/-1.0			
	Ho	16.5&17.0&19.0 +1.5/-1.0	16.5&17.0&19.0 +1.5/-1.0	16.5&17.0&19.0 +1.5/-1.0			
	L	Straight Lead	Crimped Lead	Straight Lead	Crimped Lead	Straight Lead	Crimped Lead
		11.0 Max	9.0 Max	11.0 Max	9.0 Max	11.0 Max	9.0 Max
	t1	0.5±0.2	0.5±0.2	0.5±0.2			
	t2	1.7 Max	1.7 Max	1.7 Max			