



**HESTORE.HU**

elektronikai alkatrész áruház

**EN:** This Datasheet is presented by the manufacturer.

Please visit our website for pricing and availability at [www.hestore.hu](http://www.hestore.hu).



# Installation contactors

## Installation contactors

Installation contactors are electromagnetic switching devices for switching of all kind of electric loads. They have one position of rest, capable of making, carrying and breaking currents under normal circuit conditions including operating overload conditions.



Installation contactors are the most flexible switching devices for use in all types of applications. In electronic system provide reliable, safe and efficient management of electrical equipment.

### For universal switching

- All kind of motors
- Electric heating
- Lights and lighting
- Electrical and electronic equipment

### Advanced operation

- Remote control
- Manual control

### Other benefits

- Silent hum-free AC/DC version with overvoltage protection
- Available also standard AC version
- Fast switching
- Wide application
- Mounting on 35 mm rail
- Sealing terminal covers
- Control voltages up to 400 V



Installation contactors .....	page 2
Installation contactors with manual control .....	page 6
Installation contactors with manual momentary control.....	page 9
UL/CSA installation contactors .....	page 11
Accessories .....	page 14
Installation switches and installation momentary switches .....	page 16





Ordering data .....	page 5, 8, 10, 13
Technical characteristics .....	page 18
Dimensions .....	page 38

# Installation Contactors

## up to 32 A

AC-1 acc. to IEC/EN 60947-4-1 (2-pole, 1 module)

AC

Type	Rated current I <sub>n</sub>	Control voltage at 50/60 Hz	Wiring diagram	Ordering No.	Weight (g)	Packaging (pcs)
IKA20-20	20 A	230 V		30.046.005	130	6
IKA20-20	20 A	24 V		30.046.021	130	
IKA225-20	25 A	230 V		30.046.714	130	
IKA225-20	25 A	24 V		30.046.711	130	
IKA232-20	32 A	230 V		30.046.833	130	
IKA232-20	32 A	24 V		30.046.834	130	
IKA20-11	20 A	230 V		30.046.009	130	6
IKA20-11	20 A	24 V		30.046.022	130	
IKA225-11	25 A	230 V		30.046.715	130	
IKA225-11	25 A	24 V		30.046.712	130	
IKA232-11	32 A	230 V		30.046.835	130	
IKA232-11	32 A	24 V		30.046.836	130	
IKA20-10	20 A	230 V		30.046.457	125	6
IKA20-10	20 A	24 V		30.046.837	125	
IKA225-10	25 A	230 V		30.046.713	125	
IKA225-10	25 A	24 V		30.046.710	125	
IKA232-10	32 A	230 V		30.046.838	125	
IKA232-10	32 A	24 V		30.046.839	125	
IKA20-01	20 A	230 V		30.046.716	125	6
IKA20-01	20 A	24 V		30.046.840	125	
IKA225-01	25 A	230 V		30.046.841	125	
IKA225-01	25 A	24 V		30.046.842	125	
IKA232-01	32 A	230 V		30.046.843	125	
IKA232-01	32 A	24 V		30.046.844	125	
IKA20-02	20 A	230 V		30.046.010	130	6
IKA20-02	20 A	24 V		30.046.023	130	
IKA225-02	25 A	230 V		30.046.845	130	
IKA225-02	25 A	24 V		30.046.846	130	
IKA232-02	32 A	230 V		30.046.847	130	
IKA232-02	32 A	24 V		30.046.848	130	



AC-1 acc. to IEC/EN 60947-4-1 (4-pole, 2 modules)

AC

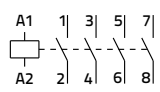
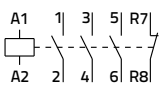
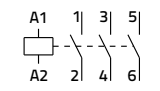
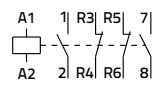
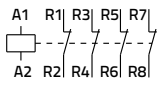
Type	Rated current I <sub>n</sub>	Control voltage at 50/60 Hz	Wiring diagram	Ordering No.	Weight (g)	Packaging (pcs)
IKA25-40	25 A	230 V		30.046.007	230	3
IKA25-40	25 A	24 V		30.046.027	230	
IKA432-40	32 A	230 V		30.046.849	230	
IKA432-40	32 A	24 V		30.046.850	230	
IKA25-31	25 A	230 V		30.046.013	230	3
IKA25-31	25 A	24 V		30.046.028	230	
IKA432-31	32 A	230 V		30.046.851	230	
IKA432-31	32 A	24 V		30.046.852	230	
IKA25-30	25 A	230 V		30.046.282	225	3
IKA25-30	25 A	24 V		30.046.853	225	
IKA432-30	32 A	230 V		30.046.854	225	
IKA432-30	32 A	24 V		30.046.855	225	
IKA25-22	25 A	230 V		30.046.014	230	3
IKA25-22	25 A	24 V		30.046.029	230	
IKA432-22	32 A	230 V		30.046.856	230	
IKA432-22	32 A	24 V		30.046.857	230	
IKA25-04	25 A	230 V		30.046.015	230	3
IKA25-04	25 A	24 V		30.046.030	230	
IKA432-04	32 A	230 V		30.046.858	230	
IKA432-04	32 A	24 V		30.046.859	230	



Other control voltages are on request - define type and voltage

AC-1 acc. to IEC/EN 60947-4-1 (4-pole, 3 modules)

63 A  
AC

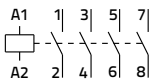
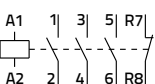
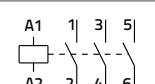
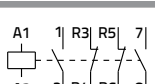
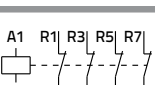
Type	Rated current I <sub>e</sub>	Control voltage at 50/60 Hz	Wiring diagram	Ordering No.	Weight (g)	Packaging (pcs)
IKA40-40	40 A	230 V		30.045.518	350	5
IKA40-40	40 A	24 V		30.045.595	350	
IKA63-40	63 A	230 V		30.045.522	350	
IKA63-40	63 A	24 V		30.045.711	350	
IKA40-31	40 A	230 V		30.045.597	350	5
IKA40-31	40 A	24 V		30.045.598	350	
IKA63-31	63 A	230 V		30.045.533	350	
IKA63-31	63 A	24 V		30.045.599	350	
IKA40-30	40 A	230 V		30.045.517	340	5
IKA40-30	40 A	24 V		30.045.600	340	
IKA63-30	63 A	230 V		30.045.521	340	
IKA63-30	63 A	24 V		30.045.601	340	
IKA40-22	40 A	230 V		30.045.519	350	5
IKA40-22	40 A	24 V		30.045.602	350	
IKA63-22	63 A	230 V		30.045.523	350	
IKA63-22	63 A	24 V		30.045.603	350	
IKA40-04	40 A	230 V		30.045.511	350	5
IKA40-04	40 A	24 V		30.045.604	350	
IKA63-04	63 A	230 V		30.045.605	350	
IKA63-04	63 A	24 V		30.045.606	350	



AC-1 acc. to IEC/EN 60947-4-1 (4-pole, 2 modules)

20 A  
AC

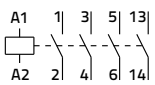
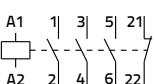
Type	Rated current I <sub>e</sub>	Control voltage at 50/60 Hz	Wiring diagram	Ordering No.	Weight (g)	Packaging (pcs)
IK21-10	20 A	220-240 V		30.041.246	170	10
IK21-10	20 A	24 V		30.041.289	170	
IK21-01	20 A	220-240 V		30.041.245	170	10
IK21-01	20 A	24 V		30.041.249	170	

SLIM CASE



AC-1 acc. to IEC/EN 60947-4-1 (2-pole, 1 module)

32 A  
AC/DC

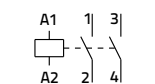
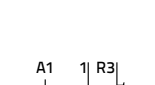
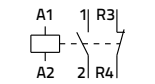
Type	Rated current I <sub>e</sub>	Control voltage at 50/60 Hz	Wiring diagram	Ordering No.	Weight (g)	Packaging (pcs)
IKD20-20	20 A	230 V AC		30.046.006	130	6
IKD20-20	20 A	220 V DC		30.046.024	130	
IKD225-20	25 A	24 V AC/DC		30.046.860	130	
IKD225-20	25 A	230 V AC		30.046.861	130	
IKD232-20	32 A	230 V AC		30.046.862	130	6
IKD232-20	32 A	220 V DC		30.046.863	130	
IKD20-11	20 A	24 V AC/DC		30.046.011	130	
IKD20-11	20 A	230 V AC		30.046.025	130	
IKD225-11	25 A	230 V AC		30.046.864	130	6
IKD225-11	25 A	220 V DC		30.046.865	130	
IKD232-11	32 A	24 V AC/DC		30.046.866	130	
IKD232-11	32 A	230 V AC		30.046.867	130	

HUM-FREE



Other control voltages are on request - define type and voltage



# Installation Contactors

## up to 32 A

AC-1 acc. to IEC/EN 60947-4-1 (2-pole, 1 module)

AC/DC

HUM-FREE

Type	Rated current I <sub>n</sub>	Control voltage at 50/60 Hz	Wiring diagram	Ordering No.	Weight (g)	Packaging (pcs)
IKD20-10	20 A	230 V AC		30.046.868	125	6
		220 V DC		30.046.590	125	
IKD225-10	25 A	230 V AC		30.046.869	125	
		220 V DC		30.046.870	125	
IKD232-10	32 A	230 V AC		30.046.871	125	
		220 V DC		30.046.872	125	
IKD20-01	20 A	230 V AC		30.046.873	125	6
		220 V DC		30.046.874	125	
IKD225-01	25 A	230 V AC		30.046.875	125	
		220 V DC		30.046.876	125	
IKD232-01	32 A	230 V AC		30.046.877	125	
		220 V DC		30.046.878	125	
IKD20-02	20 A	230 V AC		30.046.012	130	6
		220 V DC		30.046.026	130	
IKD225-02	25 A	230 V AC		30.046.879	130	
		220 V DC		30.046.880	130	
IKD232-02	32 A	230 V AC		30.046.881	130	
		220 V DC		30.046.882	130	



AC-1 acc. to IEC/EN 60947-4-1 (4-pole, 2 modules)

AC/DC

HUM-FREE

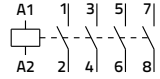
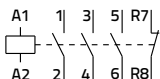
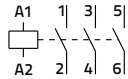
Type	Rated current I <sub>n</sub>	Control voltage at 50/60 Hz	Wiring diagram	Ordering No.	Weight (g)	Packaging (pcs)		
IKD25-40	25 A	230 V AC		30.046.008	250	3		
		220 V DC		30.046.031	250			
IKD432-40	32 A	230 V AC		30.046.883	250			
		220 V DC		30.046.884	250			
IKD25-31	25 A	230 V AC			30.046.016		250	3
		220 V DC			30.046.032		250	
IKD432-31	32 A	230 V AC	30.046.885		250			
		220 V DC	30.046.886		250			
IKD25-30	25 A	230 V AC			30.046.887	245	3	
		220 V DC			30.046.888	245		
IKD432-30	32 A	230 V AC		30.046.889	245			
		220 V DC		30.046.890	245			



Other control voltages are on request - define type and voltage

AC-1 acc. to IEC/EN 60947-4-1 (4-pole, 2 modules)

32 A  
AC/DC

HUM-FREE

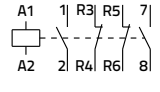
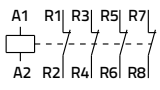
Type	Rated current I <sub>n</sub>	Control voltage at 50/60 Hz	Wiring diagram	Ordering No.	Weight (g)	Packaging (pcs)		
IKD25-22	25 A	230 V AC		30.046.017	250	3		
		220 V DC		30.046.033	250			
IKD432-22	32 A	230 V AC		30.046.891	250			
		220 V DC		30.046.892	250			
IKD25-04	25 A	230 V AC			30.046.018		250	3
		220 V DC			30.046.034		250	
IKD25-04	25 A	24 V AC/DC			30.046.893		250	
		230 V AC			30.046.894		250	
IKD432-04	32 A	230 V AC	30.046.894		250			
		220 V DC						



AC-1 acc. to IEC/EN 60947-4-1 (4-pole, 3 modules)

63 A  
AC/DC

HUM-FREE

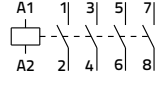
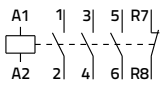
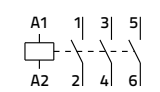
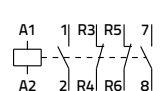
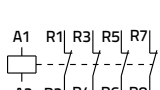
Type	Rated current I <sub>n</sub>	Control voltage at 50/60 Hz	Wiring diagram	Ordering No.	Weight (g)	Packaging (pcs)		
IK40-40	40 A	230 V AC		30.045.010	420	5		
		220 V DC		30.045.022	420			
IK63-40	63 A	230 V AC		30.045.011	420			
		220 V DC		30.045.187	420			
IK40-31	40 A	230 V AC			30.045.086		420	5
		220 V DC			30.045.485		420	
IK40-31	40 A	24 V AC/DC			30.045.087		420	
		230 V AC			30.045.234		420	
IK63-31	63 A	220 V DC	30.045.234		420			
		24 V AC/DC						
IK40-30	40 A	230 V AC			30.045.268	410	5	
		220 V DC			30.045.607	410		
IK40-30	40 A	24 V AC/DC		30.045.608	410			
		230 V AC		30.045.609	410			
IK63-30	63 A	220 V DC		30.045.609	410			
		24 V AC/DC						
IK40-22	40 A	230 V AC			30.045.150	420		5
		220 V DC			30.045.172	420		
IK40-22	40 A	24 V AC/DC	30.045.235		420			
		230 V AC	30.045.233		420			
IK63-22	63 A	220 V DC	30.045.233		420			
		24 V AC/DC						
IK40-04	40 A	230 V AC			30.045.145	420	5	
		220 V DC			30.045.232	420		
IK40-04	40 A	24 V AC/DC		30.045.610	420			
		230 V AC		30.045.611	420			
IK63-04	50 A	220 V DC		30.045.611	420			
		24 V AC/DC						



Other control voltages are on request - define type and voltage

## Ordering data

IKA63 - 40 / 12 V

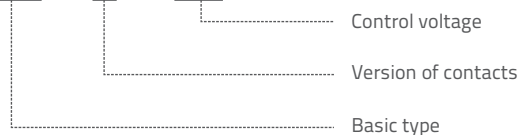

# Installation Contactors with Manual Control

## up to 32 A



IKA\*-R and IKD\*-R are upgraded version of basic types of contactors. Besides basic functions they enable manual control with a handle.

Description of the handle position:





- **A:** the contactor functions as an installation contactor without manual control
- **O:** permanently switched off control voltage
- **I:** at manual shifting the handle from position **A** to **I** causes the contactor to close; when control voltage is applied, the handle is automatically set to position **A**.

Contactor with manual control enable:

- switching depending on tariff (selection of the most convenient tariff)
- switching when control voltage is not applied

AC-1 acc. to IEC/EN 60947-4-1 (2-pole, 1 module)

AC

Type	Rated current I <sub>n</sub>	Control voltage at 50/60 Hz	Wiring diagram	Ordering No.	Weight (g)	Packaging (pcs)
IKA20-20-R	20 A	230 V		30.046.265	130	6
IKA20-20-R	20 A	24 V		30.046.268	130	
IKA225-20-R	25 A	230 V		30.046.895	130	
IKA225-20-R	25 A	24 V		30.046.896	130	
IKA232-20-R	32 A	230 V		30.046.897	130	
IKA232-20-R	32 A	24 V		30.046.898	130	
IKA20-11-R	20 A	230 V		30.046.266	130	6
IKA20-11-R	20 A	24 V		30.046.269	130	
IKA225-11-R	25 A	230 V		30.046.899	130	
IKA225-11-R	25 A	24 V		30.046.900	130	
IKA232-11-R	32 A	230 V		30.046.901	130	
IKA232-11-R	32 A	24 V		30.046.902	130	
IKA20-10-R	20 A	230 V		30.046.496	125	6
IKA20-10-R	20 A	24 V		30.046.903	125	
IKA225-10-R	25 A	230 V		30.046.904	125	
IKA225-10-R	25 A	24 V		30.046.905	125	
IKA232-10-R	32 A	230 V		30.046.906	125	
IKA232-10-R	32 A	24 V		30.046.907	125	
IKA20-01-R	20 A	230 V		30.046.908	125	6
IKA20-01-R	20 A	24 V		30.046.909	125	
IKA225-01-R	25 A	230 V		30.046.910	125	
IKA225-01-R	25 A	24 V		30.046.911	125	
IKA232-01-R	32 A	230 V		30.046.912	125	
IKA232-01-R	32 A	24 V		30.046.913	125	
IKA20-02-R	20 A	230 V		30.046.267	130	6
IKA20-02-R	20 A	24 V		30.046.270	130	
IKA225-02-R	25 A	230 V		30.046.914	130	
IKA225-02-R	25 A	24 V		30.046.915	130	
IKA232-02-R	32 A	230 V		30.046.916	130	
IKA232-02-R	32 A	24 V		30.046.917	130	



Other control voltages are on request - define type and voltage



AC-1 acc. to IEC/EN 60947-4-1 (4-pole, 2 module)

AC

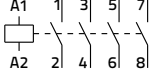
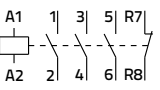
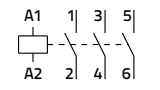
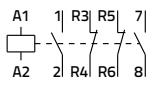
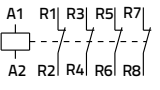

Type	Rated current I <sub>e</sub>	Control voltage at 50/60 Hz	Wiring diagram	Ordering No.	Weight (g)	Packaging (pcs)
IKA25-40-R	25 A	230 V		30.046.271	230	3
IKA25-40-R	25 A	24 V		30.046.275	230	
IKA432-40-R	32 A	230 V		30.046.918	230	
IKA432-40-R	32 A	24 V		30.046.919	230	
IKA25-31-R	25 A	230 V		30.046.272	230	3
IKA25-31-R	25 A	24 V		30.046.276	230	
IKA432-31-R	32 A	230 V		30.046.920	230	
IKA432-31-R	32 A	24 V		30.046.921	230	
IKA25-30-R	25 A	230 V		30.046.922	225	3
IKA25-30-R	25 A	24 V		30.046.923	225	
IKA432-30-R	32 A	230 V		30.046.924	225	
IKA432-30-R	32 A	24 V		30.046.925	225	
IKA25-22-R	25 A	230 V		30.046.273	230	3
IKA25-22-R	25 A	24 V		30.046.277	230	
IKA432-22-R	32 A	230 V		30.046.926	230	
IKA432-22-R	32 A	24 V		30.046.927	230	
IKA25-04-R	25 A	230 V		30.046.274	230	3
IKA25-04-R	25 A	24 V		30.046.278	230	
IKA432-04-R	32 A	230 V		30.046.928	230	
IKA432-04-R	32 A	24 V		30.046.929	230	



AC-1 acc. to IEC/EN 60947-4-1 (2-pole, 1 module)

AC/DC

HUM-FREE

Type	Rated current I <sub>e</sub>	Control voltage at 50/60 Hz	Wiring diagram	Ordering No.	Weight (g)	Packaging (pcs)
IKD20-20-R	20 A	230 V AC		30.046.381	130	6
IKD20-20-R	20 A	220 V DC		30.046.506	130	
IKD225-20-R	25 A	24 V AC/DC		30.046.930	130	
IKD225-20-R	25 A	230 V AC		30.046.931	130	
IKD225-20-R	25 A	220 V DC		30.046.932	130	
IKD225-20-R	25 A	24 V AC/DC		30.046.933	130	
IKD20-11-R	20 A	230 V AC		30.046.507	130	6
IKD20-11-R	20 A	220 V DC		30.046.508	130	
IKD225-11-R	25 A	24 V AC/DC		30.046.934	130	
IKD225-11-R	25 A	230 V AC		30.046.935	130	
IKD225-11-R	25 A	220 V DC		30.046.936	130	
IKD225-11-R	25 A	24 V AC/DC		30.046.937	130	
IKD20-10-R	20 A	230 V AC		30.046.938	125	6
IKD20-10-R	20 A	220 V DC		30.046.939	125	
IKD225-10-R	25 A	24 V AC/DC		30.046.940	125	
IKD225-10-R	25 A	230 V AC		30.046.941	125	
IKD225-10-R	25 A	220 V DC		30.046.942	125	
IKD225-10-R	25 A	24 V AC/DC		30.046.943	125	





Other control voltages are on request - define type and voltage

# Installation Contactors with Manual Control up to 32 A

AC-1 acc. to IEC/EN 60947-4-1 (2-pole, 1 module)

AC/DC

HUM-FREE

Type	Rated current I <sub>n</sub>	Control voltage at 50/60 Hz	Wiring diagram	Ordering No.	Weight (g)	Packaging (pcs)
IKD20-01-R	20 A	230 V AC		30.046.944	125	6
IKD20-01-R	20 A	220 V DC		30.046.945	125	
IKD225-01-R	25 A	230 V AC		30.046.946	125	
IKD225-01-R	25 A	220 V DC		30.046.947	125	
IKD232-01-R	32 A	230 V AC		30.046.948	125	
IKD232-01-R	32 A	220 V DC		30.046.949	125	
IKD20-02-R	20 A	230 V AC		30.046.950	130	6
IKD20-02-R	20 A	220 V DC		30.046.951	130	
IKD225-02-R	25 A	230 V AC		30.046.952	130	
IKD225-02-R	25 A	220 V DC		30.046.953	130	
IKD232-02-R	32 A	230 V AC		30.046.954	130	
IKD232-02-R	32 A	220 V DC		30.046.955	130	



AC-1 acc. to IEC/EN 60947-4-1 (4-pole, 2 modules)

AC/DC

HUM-FREE

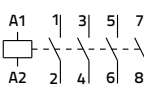
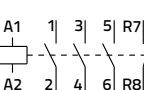
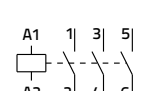
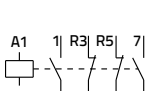
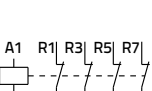
Type	Rated current I <sub>n</sub>	Control voltage at 50/60 Hz	Wiring diagram	Ordering No.	Weight (g)	Packaging (pcs)
IKD25-40-R	25 A	230 V AC		30.046.509	250	3
IKD25-40-R	25 A	220 V DC		30.046.510	250	
IKD432-40-R	32 A	230 V AC		30.046.956	250	
IKD432-40-R	32 A	220 V DC	30.046.957	250		
IKD25-31-R	25 A	230 V AC		30.046.958	250	3
IKD25-31-R	25 A	220 V DC		30.046.959	250	
IKD432-31-R	32 A	230 V AC		30.046.960	250	
IKD432-31-R	32 A	220 V DC	30.046.961	250		
IKD25-30-R	25 A	230 V AC		30.046.962	245	3
IKD25-30-R	25 A	220 V DC		30.046.963	245	
IKD432-30-R	32 A	230 V AC		30.046.964	245	
IKD432-30-R	32 A	220 V DC	30.046.965	245		
IKD25-22-R	25 A	230 V AC		30.046.966	250	3
IKD25-22-R	25 A	220 V DC		30.046.967	250	
IKD432-22-R	32 A	230 V AC		30.046.968	250	
IKD432-22-R	32 A	220 V DC		30.046.969	250	
IKD25-04-R	25 A	230 V AC		30.046.970	250	3
IKD25-04-R	25 A	220 V DC		30.046.971	250	
IKD432-04-R	32 A	230 V AC		30.046.972	250	
IKD432-04-R	32 A	220 V DC		30.046.973	250	



Other control voltages are on request - define type and voltage

## Ordering data

IKA20 - 20 - R / 12 V

- ..... Control voltage
- ..... Manual control
- ..... Version of contacts
- ..... Basic type







IKA\*-T and IKD\*-T are upgraded version of basic types of contactors. Besides basic functions they enable manual control with a handle.

Description of the handle position:

- **A:** the contactor functions as an installation contactor
- **O:** permanently switched off control voltage
- **I:** momentary switch-on depending of manual activation

### AC-1 acc. to IEC/EN 60947-4-1 (2-pole, 1 module)





AC

Type	Rated current I <sub>e</sub>	Control voltage at 50/60 Hz	Wiring diagram	Ordering No.	Weight (g)	Packaging (pcs)
IKA20-20-T	20 A	230 V		30.046.974	130	6
IKA225-20-T	25 A	230 V		30.046.975	130	
IKA232-20-T	32 A	230 V		30.046.976	130	
IKA20-11-T	20 A	230 V		30.046.977	130	6
IKA225-11-T	25 A	230 V		30.046.978	130	
IKA232-11-T	32 A	230 V		30.046.979	130	
IKA20-10-T	20 A	230 V		30.046.980	125	6
IKA225-10-T	25 A	230 V		30.046.981	125	
IKA232-10-T	32 A	230 V		30.046.982	125	
IKA20-01-T	20 A	230 V		30.046.983	125	6
IKA225-01-T	25 A	230 V		30.046.984	125	
IKA232-01-T	32 A	230 V		30.046.985	125	
IKA20-02-T	20 A	230 V		30.046.986	130	6
IKA225-02-T	25 A	230 V		30.046.987	130	
IKA232-02-T	32 A	230 V		30.046.988	130	



### AC-1 acc. to IEC/EN 60947-4-1 (4-pole, 2 modules)

AC

Type	Rated current I <sub>e</sub>	Control voltage at 50/60 Hz	Wiring diagram	Ordering No.	Weight (g)	Packaging (pcs)
IKA25-40-T	25 A	230 V		30.046.989	230	3
IKA432-40-T	32 A	230 V		30.046.990	230	
IKA25-31-T	25 A	230 V		30.046.991	230	3
IKA432-31-T	32 A	230 V		30.046.992	230	
IKA25-30-T	25 A	230 V		30.046.993	225	3
IKA432-30-T	32 A	230 V		30.046.994	225	
IKA25-22-T	25 A	230 V		30.046.995	230	3
IKA432-22-T	32 A	230 V		30.046.996	230	
IKA25-04-T	25 A	230 V		30.046.997	230	3
IKA432-04-T	32 A	230 V		30.046.998	230	



Other control voltages are on request - define type and voltage

# Installation Contactors with Manual Momentary Control up to 32 A

AC-1 acc. to IEC/EN 60947-4-1 (2-pole, 1 module)

HUM-FREE

AC/DC

Type	Rated current I <sub>n</sub>	Control voltage at 50 Hz	Wiring diagram	Ordering No.	Weight (g)	Packaging (pcs)
IKD20-20-T	20 A	230 V AC 220 V DC		30.046.999	130	6
IKD225-20-T	25 A	230 V AC 220 V DC		30.047.000	130	
IKD232-20-T	32 A	230 V AC 220 V DC		30.047.001	130	
IKD20-11-T	20 A	230 V AC 220 V DC		30.047.002	130	6
IKD225-11-T	25 A	230 V AC 220 V DC		30.047.003	130	
IKD232-11-T	32 A	230 V AC 220 V DC		30.047.004	130	
IKD20-10-T	20 A	230 V AC 220 V DC		30.047.005	125	6
IKD225-10-T	25 A	230 V AC 220 V DC		30.047.006	125	
IKD232-10-T	32 A	230 V AC 220 V DC		30.047.007	125	
IKD20-01-T	20 A	230 V AC 220 V DC		30.047.008	125	6
IKD225-01-T	25 A	230 V AC 220 V DC		30.047.009	125	
IKD232-01-T	32 A	230 V AC 220 V DC		30.047.010	125	
IKD20-02-T	20 A	230 V AC 220 V DC		30.047.011	130	6
IKD225-02-T	25 A	230 V AC 220 V DC		30.047.012	130	
IKD232-02-T	32 A	230 V AC 220 V DC		30.047.013	130	



AC-1 acc. to IEC/EN 60947-4-1 (4-pole, 2 modules)

HUM-FREE

AC/DC

Type	Rated current I <sub>n</sub>	Control voltage at 50/60 Hz	Wiring diagram	Ordering No.	Weight (g)	Packaging (pcs)
IKD25-40-T	25 A	230 V AC 220 V DC		30.047.014	250	3
IKD432-40-T	32 A	230 V AC 220 V DC		30.047.015	250	
IKD25-31-T	25 A	230 V AC 220 V DC		30.047.016	250	3
IKD432-31-T	32 A	230 V AC 220 V DC		30.047.017	250	
IKD25-30-T	25 A	230 V AC 220 V DC		30.047.018	245	3
IKD432-30-T	32 A	230 V AC 220 V DC		30.047.019	245	
IKD25-22-T	25 A	230 V AC 220 V DC		30.047.020	250	3
IKD432-22-T	32 A	230 V AC 220 V DC		30.047.021	250	
IKD25-04-T	25 A	230 V AC 220 V DC		30.047.022	250	3
IKD432-04-T	32 A	230 V AC 220 V DC		30.047.023	250	



Other control voltages are on request - define type and voltage

## Ordering data

**IKA20 - 20 - T / 12 V**

- Control voltage
- Manual momentary control
- Version of contacts
- Basic type







Special designed installation contactors for markets who required UL and CSA approval.



General Use acc. to UL 60947-4-1 (2-pole, 1 module)





20 A  
AC

Type	Rated current I <sub>e</sub>	Control voltage at 50/60 Hz	Wiring diagram	Ordering No.	Weight (g)	Packaging (pcs)
IKA220-20	20 A	230 V		30.046.825	130	6
IKA220-20		120 V		30.047.024	130	
IKA220-20		24 V		30.047.025	130	
IKA220-11	20 A	230 V		30.047.289	130	6
IKA220-11		120 V		30.047.026	130	
IKA220-11		24 V		30.047.027	130	
IKA220-10	20 A	230 V		30.047.290	130	6
IKA220-10		120 V		30.047.028	125	
IKA220-10		24 V		30.047.029	125	
IKA220-01	20 A	230 V		30.047.291	130	6
IKA220-01		120 V		30.047.030	125	
IKA220-01		24 V		30.047.031	125	
IKA220-02	20 A	230 V		30.047.291	130	6
IKA220-02		120 V		30.047.032	130	
IKA220-02		24 V		30.047.033	130	



General Use acc. to UL 60947-4-1 (4-pole, 2 modules)

25 A  
AC

Type	Rated current I <sub>e</sub>	Control voltage at 50/60 Hz	Wiring diagram	Ordering No.	Weight (g)	Packaging (pcs)
IKA425-40	25 A	230 V		30.046.827	230	3
IKA425-40		120 V		30.047.034	230	
IKA425-40		24 V		30.047.035	230	
IKA425-31	25 A	230 V		30.047.293	230	3
IKA425-31		120 V		30.047.036	230	
IKA425-31		24 V		30.047.037	230	
IKA425-30	25 A	230 V		30.047.294	225	3
IKA425-30		120 V		30.047.038	225	
IKA425-30		24 V		30.047.039	225	
IKA425-22	25 A	230 V		30.047.295	230	3
IKA425-22		120 V		30.047.040	230	
IKA425-22		24 V		30.047.041	230	
IKA425-04	25 A	230 V		30.047.296	230	3
IKA425-04		120 V		30.047.042	230	
IKA425-04		24 V		30.047.043	230	



Other control voltages are on request - define type and voltage

# UL/CSA Installation Contactors

## from 20 A up to 63 A



General Use acc. to UL 60947-4-1 (4-pole, 3 modules)

63 A  
AC

Type	Rated current I <sub>n</sub>	Control voltage at 50/60 Hz	Wiring diagram	Ordering No.	Weight (g)	Packaging (pcs)
IKA440-40	40 A	230 V		30.045.700	350	5
IKA440-40	40 A	120 V		30.045.612	350	
IKA440-40	40 A	24 V		30.045.613	350	
IKA463-40	63 A	230 V		30.045.592	350	
IKA463-40	63 A	120 V		30.045.614	350	
IKA463-40	63 A	24 V		30.045.615	350	
IKA440-31	40 A	230 V		30.045.701	350	5
IKA440-31	40 A	120 V		30.045.616	350	
IKA463-31	40 A	24 V		30.045.617	350	
IKA463-31	63 A	230 V		30.045.702	350	
IKA463-31	63 A	120 V		30.045.618	350	
IKA463-31	63 A	24 V		30.045.619	350	
IKA440-30	40 A	230 V		30.045.703	340	5
IKA440-30	40 A	120 V		30.045.620	340	
IKA463-30	40 A	24 V		30.045.621	340	
IKA463-30	63 A	230 V		30.045.704	340	
IKA463-30	63 A	120 V		30.045.622	340	
IKA463-30	63 A	24 V		30.045.623	340	
IKA440-22	40 A	230 V		30.045.705	350	5
IKA440-22	40 A	120 V		30.045.624	350	
IKA463-22	40 A	24 V		30.045.625	350	
IKA463-22	63 A	230 V		30.045.706	350	
IKA463-22	63 A	120 V		30.045.626	350	
IKA463-22	63 A	24 V		30.045.627	350	
IKA440-04	40 A	230 V		30.045.707	350	5
IKA440-04	40 A	120 V		30.045.628	350	
IKA463-04	40 A	24 V		30.045.629	350	
IKA463-04	63 A	230 V		30.045.708	350	
IKA463-04	63 A	120 V		30.045.630	350	
IKA463-04	63 A	24 V		30.045.631	350	



General Use acc. to UL 60947-4-1 (2-pole, 1 module)

20 A  
AC/DC

Type	Rated current I <sub>n</sub>	Control voltage at 50/60 Hz	Wiring diagram	Ordering No.	Weight (g)	Packaging (pcs)
IKD220-20	20 A	230 V AC		30.046.826	130	6
		220 V DC		30.047.044		
		120 V AC		30.047.045		
IKD220-11	20 A	24 V AC/DC		30.047.297	130	6
		230 V AC		30.047.046		
		220 V DC		30.047.047		
IKD220-10	20 A	120 V AC		30.047.298	125	6
		230 V AC		30.047.048		
		110 V DC		30.047.049		
IKD220-01	20 A	24 V AC/DC		30.047.299	125	6
		230 V AC		30.047.050		
		220 V DC		30.047.051		
IKD220-02	20 A	230 V AC		30.047.300	130	6
		220 V DC		30.047.052		
		120 V AC		30.047.053		

HUM-FREE





Other control voltages are on request - define type and voltage

General Use acc. to UL 60947-4-1 (4-pole, 2 modules)

25 A  
AC/DC

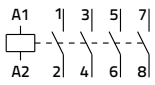
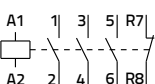
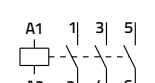
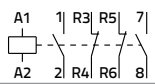
HUM-FREE

Type	Rated current I <sub>e</sub>	Control voltage at 50/60 Hz	Wiring diagram	Ordering No.	Weight (g)	Packaging (pcs)
IKD425-40	25 A	230 V AC		30.046.828	250	6
		220 V DC		30.047.054	250	
		120 V AC 110 V DC		30.047.055	250	
IKD425-31	25 A	230 V AC		30.047.301	250	6
		220 V DC		30.047.056	250	
		120 V AC 110 V DC		30.047.057	250	
IKD425-30	25 A	230 V AC		30.047.302	245	6
		220 V DC		30.047.058	245	
		120 V AC 110 V DC		30.047.059	245	
IKD425-22	25 A	230 V AC		30.047.303	250	6
		220 V DC		30.047.060	250	
		120 V AC 110 V DC		30.047.061	250	
IKD425-04	25 A	120 V AC		30.047.062	250	6
		110 V DC		30.047.062	250	
		24 V AC/DC		30.047.063	250	



General Use acc. to UL 60947-4-1 (4-pole, 3 modules)

63 A  
AC/DC

HUM-FREE

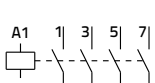
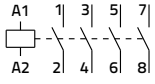
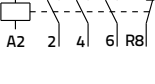
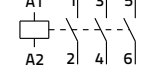
Type	Rated current I <sub>e</sub>	Control voltage at 50/60 Hz	Wiring diagram	Ordering No.	Weight (g)	Packaging (pcs)
IKD440-40	40 A	230 V AC		30.045.709	420	5
		220 V DC		30.045.632	420	
		120 V AC 110 V DC		30.045.633	420	
IKD463-40	63 A	24 V AC/DC		30.045.593	420	5
		230 V AC		30.045.634	420	
		220 V DC		30.045.635	420	
IKD440-31	40 A	230 V AC		30.045.710	420	5
		220 V DC		30.045.636	420	
		120 V AC 110 V DC		30.045.637	420	
IKD463-31	63 A	24 V AC/DC		30.045.711	420	5
		230 V AC		30.045.638	420	
		220 V DC		30.045.639	420	
IKD440-30	40 A	230 V AC		30.045.712	410	5
		220 V DC		30.045.640	410	
		120 V AC 110 V DC		30.045.641	410	
IKD463-30	63 A	24 V AC/DC		30.045.713	410	5
		230 V AC		30.045.642	410	
		220 V DC		30.045.643	410	



Other control voltages are on request - define type and voltage

# UL/CSA Installation Contactors

## from 20 A up to 63 A

General Use acc. to UL 60947-4-1 (4-pole, 3 modules)

63 A  
AC/DC

HUM-FREE

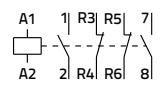
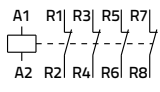
Type	Rated current I <sub>n</sub>	Control voltage at 50/60 Hz	Wiring diagram	Ordering No.	Weight (g)	Packaging (pcs)		
IKD440-22	40 A	230 V AC		30.045.714	420	5		
		220 V DC		30.045.644	420			
IKD440-22	40 A	120 V AC		30.045.645	420			
		110 V DC		30.045.715	420			
IKD463-22	63 A	230 V AC		30.045.646	420			
		220 V DC		30.045.647	420			
IKD463-22	63 A	120 V AC			30.045.594		420	5
		110 V DC			30.045.648		420	
IKD440-04	40 A	230 V AC	30.045.649		420			
		220 V DC						
IKD440-04	40 A	120 V AC						
		110 V DC						
IKD440-04	40 A	24 V AC/DC						



Other control voltages are on request - define type and voltage

## Ordering data

IKA440 - 40 / 12 V

- ..... Control voltage
- ..... Version of contacts
- ..... Basic type

# Installation Contactors

## Accessories

Sealing cover for 2-pole, 1 module

Type	Ordering No.	Weight (g)	Packaging (pcs)
IK20-PP	37.425.061	1	2



Sealing cover for 4-pole, 2 modules

Type	Ordering No.	Weight (g)	Packaging (pcs)
IK25-PP	37.425.062	2	2



Sealing cover for 4-pole, 3 modules

Type	Ordering No.	Weight (g)	Packaging (pcs)
IK40/63-PP	37.423.463	3	2





## Ventilation modul

Type	Ordering No.	Weight (g)	Packaging (pcs)
IKV	37.425.296	13	1



## Auxiliary switch

AC-15 acc. to IEC/EN 60947-5-1 (2-pole, ½ module)

Type	Rated current I <sub>e</sub>	Wiring diagram					Ordering No.	Weight (g)	Packaging (pcs)
		-20	-11	-01	-10	-02			
IKN20	6 A						38.046.002	30	1
IKN11	6 A	33 43	31 43	31	33	31 41	38.046.004	30	
IKN10	6 A	33 43	31 43	31	33	31 41	38.046.036	25	
IKN01	6 A	34 44	32 44	32	34	32 42	38.046.037	30	
IKN02	6 A	34 44	32 44	32	34	32 42	38.046.003	30	



## Auxiliary switch

Ratings acc. to UL 508 (2-pole, ½ module)

Type	Rating code	Wiring diagram			Ordering No.	Weight (g)	Packaging (pcs)
		-20	-11	-02			
IKN20UL	C300, Q300	33 43	31 43	31 41	38.046.050	30	1
IKN11UL	C300, Q300	33 43	31 43	31 41	38.046.049	30	
IKN02UL	C300, Q300	34 44	32 44	32 42	38.046.051	30	



## 4-phase busbars for installation contactors up to 32 A

- insulated

Type	Module width	Length (mm)	Ordering No.	Weight (g)	Packaging (pcs)
L/32-8P	4	66	38.046.061	60	10
L/32-12P	6	98	38.046.062	86	
L/32-16P	8	138	38.046.063	114	
L/32-20P	10	173	38.046.064	141	
L/32-24P	12	208	38.046.065	169	

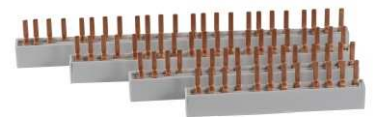

## Single pin terminals for installation contactors up to 32 A

- insulated

Type	Pin length	Cross-section rigid/flexible (mm <sup>2</sup> )	Screw	Ordering No.	Weight (g)	Packaging (pcs)
S/32-1P	13.5/32 (total)	6-25/4-16	PZ2	38.046.066	12	25

## Double pin terminals for installation contactors 40 -63 A



- insulated terminals for parallel connection

Type	Pin length	Cross-section rigid/flexible (mm <sup>2</sup> )	Screw	Ordering No.	Weight (g)	Packaging (pcs)
S/63-2P	15	6-50/4-35	PZ2	38.046.067	22	25

# Installation Switches and Installation Momentary Switches



IKS-R installation switches are designed for manual switching of loads with a handle in the same look as the installation contactors.

AC-21 acc. to IEC/EN 60947-3 (2-pole, 1 module)

Type	Rated current I <sub>e</sub>	Wiring diagram	Ordering No.	Weight (g)	Packaging (pcs)
IKS220-20-R	20 A		30.047.064	55	6
IKS225-20-R	25 A		30.047.065	55	
IKS232-20-R	32 A		30.047.066	55	
IKS220-11-R	20 A		30.047.067	55	6
IKS225-11-R	25 A		30.047.068	55	
IKS232-11-R	32 A		30.047.069	55	





AC-21 acc. to IEC/EN 60947-3 (4-pole, 2 modules)

Type	Rated current I <sub>e</sub>	Wiring diagram	Ordering No.	Weight (g)	Packaging (pcs)
IKS420-40-R	20 A		30.047.070	105	3
IKS425-40-R	25 A		30.047.071	105	
IKS432-40-R	32 A		30.047.072	105	
IKS420-31-R	20 A		30.047.073	105	3
IKS425-31-R	25 A		30.047.074	105	
IKS432-31-R	32 A		30.047.075	105	
IKS420-22-R	20 A		30.047.076	105	3
IKS425-22-R	25 A		30.047.077	105	
IKS432-22-R	32 A		30.047.078	105	





IKS-T installation momentary switches are designed for manual momentary switching of loads with a handle in the same look as the installation contactors.

AC-21 acc. to IEC/EN 60947-3 (2-pole, 1 module)

Type	Rated current I <sub>e</sub>	Wiring diagram	Ordering No.	Weight (g)	Packaging (pcs)
IKS220-20-T	20 A		30.047.079	55	6
IKS225-20-T	25 A		30.047.080	55	
IKS232-20-T	32 A		30.047.081	55	
IKS220-11-T	20 A		30.047.082	55	6
IKS225-11-T	25 A		30.047.083	55	
IKS232-11-T	32 A		30.047.084	55	



AC-21 acc. to IEC/EN 60947-3 (4-pole, 2 modules)

Type	Rated current I <sub>e</sub>	Wiring diagram	Ordering No.	Weight (g)	Packaging (pcs)
IKS420-40-T	20 A		30.047.085	105	3
IKS425-40-T	25 A		30.047.086	105	
IKS432-40-T	32 A		30.047.087	105	
IKS420-31-T	20 A		30.047.088	105	3
IKS425-31-T	25 A		30.047.089	105	
IKS432-31-T	32 A		30.047.090	105	
IKS420-22-T	20 A		30.047.091	105	3
IKS425-22-T	25 A		30.047.092	105	
IKS432-22-T	32 A		30.047.093	105	





# Technical characteristics

## Dimensions



# Installation Contactors

## up to 25 A



### TECHNICAL DATA

	Type	Symbol	Unit	IK21	IKA20	IKD20	IKA225	IKD225
					IKA20-R IKA20-T <sup>1)</sup>	IKD20-R IKD20-T <sup>1)</sup>	IKA225-R IKA225-T <sup>1)</sup>	IKD225-R IKD225-T <sup>1)</sup>
Standards				IEC/EN 61095, IEC/EN 60947-4-1, IEC/EN 60947-5-1				
Approvals				CE, EAC	CE, CB, NF, EAC		CE	
Module width				2	1			
Number of poles				4	2			
Degree of protection				IP20 (IP40 when installed in installation box - distribution board)				
Pollution degree				3				
Climatic conditions				95 % relative humidity				
Ambient temperature (open)			°C	-15 ... +55 <sup>4)</sup>				
Storage temperature			°C	-30... +80				
Maximum altitude U <sub>i</sub> and U <sub>e</sub> is reduced for 1.2 % and I <sub>e</sub> for 0.4 % for every additional 100 m			m	2000				
Number of contactors or switches side-by-side: <40 °C (40 ... 55) °C				no limitation	max. 3 max. 2			
Noise level (operation)			dB	30	30	20	30	20
Vibration resistance according to IEC/EN 60068-2-6	a		g	switched off: 2 (Z and X axis) / switched on: 3 (Z axis) and 1 (X axis)				
Shock resistance according to IEC/EN 6068-2-27	a		g	switched off: 10 (Z and X axis) / switched on: 15 (Z axis) and 2 (X axis)				
Maximum operating frequency with no load			op. c./h	3.000				
Mechanical endurance			op. c.	3.000.000	10.000.000	3.000.000	10.000.000	
Weight			g	170	130	130	130	130
Contact reliability				≥17 V; ≥50 mA				
Minimum distance of open contacts			mm	3,6				
Power dissipation per pole			W	2,0	1,7	1,7	2,0	2,0
Overload current withstand capability: 10 s			A	40	72			
Maximum back-up fuse for short-circuit protection gL and gG: coordination type 1 coordination type 2	I <sub>v</sub>	A		20	20	20	25	25
Rated insulation voltage	U <sub>i</sub>	V		415	440			
Rated impulse withstand voltage	U <sub>imp</sub>	kV		4				
Rated operational voltage	U <sub>e</sub>	V		400	400 <sup>2)3)</sup>			
Rated frequency	f	Hz		50/60				
Thermal current	I <sub>th</sub>	A		20		25		
Rated operational current for AC-1, AC-7a and AC-21	I <sub>e</sub>	A		20		25		
Operational power for AC-1, AC-7a and AC-21: single-phase 230 V three-phase 230 V three-phase 400 V	P <sub>e</sub>	kW		7.5	4			5.4
Maximum operating frequency for AC-1, AC-7a and AC-21		op. c./h		13				
Electrical endurance for AC-1, AC-7a and AC-21		op. c.		600				
Rated operational current for AC-2	I <sub>e</sub>	A		200.000				
Operational power for AC-2: single-phase 230 V three-phase 230 V three-phase 400 V	P <sub>e</sub>	kW		10	12			14
Maximum operating frequency for AC-2		op. c./h		1.5	1.8			2.0
Electrical endurance for AC-2		op. c.		2.5				
Rated operational current for AC-22	I <sub>e</sub>	A		4.5				
Operational power for AC-22: single-phase 230 V three-phase 230 V three-phase 400 V	P <sub>e</sub>	kW		120				
Maximum operating frequency for AC-22		op. c./h		100.000				
Electrical endurance for AC-22		op. c.		300				
Rated operational current for AC-23	I <sub>e</sub>	A		20		25		
Operational power for AC-23: single-phase 230 V three-phase 230 V three-phase 400 V	P <sub>e</sub>	kW		3.7		4.6		
Maximum operating frequency for AC-23		op. c./h		50.000				
Electrical endurance for AC-23		op. c.		5				
Rated operational current for AC-3, AC-7b and AC-23	I <sub>e</sub>	A		5	NO: 9 / NC: 6			
Operational power for AC-3, AC-7b and AC-23: single-phase 230 V three-phase 230 V three-phase 400 V	P <sub>e</sub>	kW		0.37	NO: 1.3 / NC: 0.75			
Maximum operating frequency for AC-3, AC-7b and AC-23		op. c./h		1.1				
Electrical endurance for AC-3, AC-7b and AC-23		op. c.		2.2				
Maximum operating frequency for AC-3, AC-7b and AC-23		op. c./h		600				
Electrical endurance for AC-3, AC-7b and AC-23		op. c.		300.000				

<sup>1)</sup> Available approvals only CE

<sup>2)</sup> Rated operational voltage between two line (phase) conductors

<sup>3)</sup> Rated operational voltage for versions of contacts -10 and -01 is 230 V

<sup>4)</sup> Ambient temperature (open) -25...+55 °C for version with 2NO and 4NO contacts

### TECHNICAL DATA

Type	Symbol	Unit	IK21	IKA20 IKA20-R IKA20-T	IKD20 IKD20-R IKD20-T	IKA225 IKA225-R IKA225-T	IKD225 IKD225-R IKD225-T
Rated operational current for AC-5a (at 230 V)	$I_e$	A	8.8			11.2	
Maximum operating frequency for AC-5a		op. c./h	600				
Electrical endurance for AC-5a		op. c.	100.000				
Rated operational current for AC-5b (at 230 V)	$I_e$	A	8.8			9.7	
Maximum operating frequency for AC-5b		op. c./h	600				
Electrical endurance for AC-5b		op. c.	100.000				
Rated operational current for AC-6a (at 230 V)	$I_e$	A	4			4.8	
Maximum operating frequency for AC-6a		op. c./h	600				
Electrical endurance for AC-6a		op. c.	100.000				
Switching of capacitors AC-6b and AC-7c (at 230 V)	C	$\mu$ F	30			36	
Maximum operating frequency for AC-6b and AC-7c		op. c./h	600				
Electrical endurance for AC-6b and AC-7c		op. c.	100.000				
Rated operational current for DC-1 ( $L/R \leq 1$ ms): 1 pole ... 24 V DC/48 V DC/60 V DC/110 V DC/ 220 V DC 2 poles in series ... 24 V DC/48 V DC/60 V DC/110 V DC/ 220 V DC 3 poles in series ... 24 V DC/48 V DC/60 V DC/110 V DC/ 220 V DC 4 poles in series ... 24 V DC/48 V DC/60 V DC/110 V DC/ 220 V DC	$I_e$	A	20/12/6/2/0.5	20/15/10/6/0.6		25/20/15/6/0.6	
			20/15/10/4/1.5	20/18/15/10/6		25/25/20/10/6	
			20/20/20/6/2.5				
			20/20/20/6/3.5				
Maximum operating frequency for DC-1		op. c./h	300				
Electrical endurance for DC-1		op. c.	100.000				
Rated operational current for DC-3 ( $L/R \leq 2$ ms): 1 pole ... 24 V DC/48 V DC/60 V DC/110 V DC/ 220 V DC 2 poles in series ... 24 V DC/48 V DC/60 V DC/110 V DC/ 220 V DC 3 poles in series ... 24 V DC/48 V DC/60 V DC/110 V DC/ 220 V DC 4 poles in series ... 24 V DC/48 V DC/60 V DC/110 V DC/ 220 V DC	$I_e$	A	10/5/2/1/0.1			15/8/4/1.3/0.2	
			20/10/8/4/0.4			25/16/12/5.5/0.6	
			20/20/15/6/2.5				
			20/20/15/6/3.5				
Maximum operating frequency for DC-3		op. c./h	300				
Electrical endurance for DC-3		op. c.	100.000				
Rated operational current for DC-5 ( $L/R \leq 7.5$ ms): 1 pole ... 24 V DC/48 V DC/60 V DC/110 V DC/ 220 V DC 2 poles in series ... 24 V DC/48 V DC/60 V DC/110 V DC/ 220 V DC 3 poles in series ... 24 V DC/48 V DC/60 V DC/110 V DC/ 220 V DC 4 poles in series ... 24 V DC/48 V DC/60 V DC/110 V DC/ 220 V DC	$I_e$	A	10/4/1/0.3/0.06			15/5/3/0.5/0.1	
			20/8/6/2/0.2			25/15/10/4/0.4	
			20/20/15/5/1.5				
			20/20/15/5/3				
Maximum operating frequency for DC-5		op. c./h	300				
Electrical endurance for DC-5		op. c.	100.000				
Terminal capacity: rigid (solid and stranded) flexible	S	mm <sup>2</sup>	1 ... 2.5	1 ... 10			
			1 ... 2.5	1 ... 6			
Length of removed wire insulation		mm	9				
Screw			M3.5				
Screw head			PZ2				PZ1
Tightening torque		Nm	1.2				
Contact reliability			$\geq 17$ V; $\geq 50$ mA				
Minimum distance of open contacts		mm	3.6				
Power dissipation per pole		W	2	1.7	1.7	2	2
Overload current withstand capability: 10 s		A	40	72			
Maximum back-up fuse for short-circuit protection gL and gG: coordination type 1 coordination type 2	$I_v$	A				25	25
			20	20	20		
Rated insulation voltage	$U_i$	V	415	440			
Rated impulse withstand voltage	$U_{imp}$	kV	4				
Rated operational voltage	$U_e$	V	230/400				
Rated frequency	f	Hz	50/60				
Thermal current	$I_{th}$	A	20			25	
Rated operational current for AC-15: single-phase 230 V single-phase 400 V	$I_e$	A	6				
			4				
Maximum operating frequency for AC-15		op. c./h	1200	600			
Electrical endurance for AC-15		op. c.	200.000	300.000			
Rated operational current for DC-13: 1 pole ... 24 V DC/48 V DC/60 V DC/110 V DC/ 220 V DC 2 poles in series ... 24 V DC/48 V DC/60 V DC/110 V DC/ 220 V DC 3 poles in series ... 24 V DC/48 V DC/60 V DC/110 V DC/ 220 V DC 4 poles in series ... 24 V DC/48 V DC/60 V DC/110 V DC/ 220 V DC	$I_e$	A	6/4/1/0.3/0.05				
			6/6/4/1/0.1				
			6/6/6/3/1				
			6/6/6/4/2				

# Installation Contactors

## up to 25 A



### TECHNICAL DATA

Type		Symbol	Unit	IK21	IKA20 IKA20-R IKA20-T	IKD20 IKD20-R IKD20-T	IKA225 IKA225-R IKA225-T	IKD225 IKD225-R IKD225-T	
AUXILIARY CIRCUIT	Maximum operating frequency for DC-13		op. c./h	300					
	Electrical endurance for DC-13		op. c.	200.000					
	Terminal capacity: rigid (solid and stranded)	S	mm <sup>2</sup>	1 ... 2.5	1 ... 10				
	flexible			1 ... 2.5	1 ... 6				
	Length of removed wire insulation		mm	9					
	Screw			M3.5					
	Screw head		mm	PZ2	PZ1				
Tightening torque			1.2						
COIL	Range of control voltage for switch-on	$U_c$	%	85 ... 110					
	Range of control voltage for drop out	$U_c$	%	AC: 75 ... 20 / DC: 75 ... 10 (where is applicable)					
	Kind of voltage			AC		AC/DC	AC		AC/DC
	Standard control voltages	$U_c$	V	12, 24, 48, 120, 230, 400	12, 24, 48, 120, 230				
	Frequency of AC control voltage	f	Hz	50/60	40 ... 500	50/60	40 ... 500		
	Control mode			remote control with $U_c$ / manual control only for types with -R and -T					
	Impulse duration of control voltage: minimum			permanent					
	maximum			permanent					
	Minimum duration between two impulses of control voltage		ms	AC: 150 / DC: 500 (where is applicable)					
	Surge immunity withstand voltage 1.2/50 $\mu$ s acc. to standard IEC/EN 61000-4-5		kV	2					
	Coil consumption: switch-on		VA/W	30/25	12/10	2.1/2.1	12/10	2.1/2.1	
	operation	5/1.5		2.8/1.2	2.1/2.1	2.8/1.2	2.1/2.1		
	Delays: make		ms	7 ... 20	15 ... 25	15 ... 45	15 ... 25	15 ... 45	
	brake			10 ... 20	10 ... 30	20 ... 50	10 ... 30	20 ... 50	
	Terminal capacity: rigid (solid and stranded)		mm <sup>2</sup>	1 ... 2.5					
	flexible			1 ... 2.5					
	Length of removed wire insulation		mm	9	7				
	Screw			M3.5	M3				
	Screw head			PZ2	PZ1				
	Tightening torque		Nm	1.2	0.6				
SAFETY	MTTF - Mean time to failure $MTTF = 1/\lambda = B10/(0.1 n_{op})$		h	AC-1: 5.000					
				AC-3: 7.500					
	MTTF <sub>d</sub> - Mean time to failure dangerous $MTTF_d = 1/\lambda_d = B10_d/(0.1 n_{op})$		h	AC-1: 6.666					
				AC-3: 10.000					
	B10 - Number of operating cycles until 10 % of devices fail		op. c.	AC-1: 150.000					
				AC-3: 225.000					
	B10 <sub>d</sub> - Number of operating cycles until 10 % of device dangerous		op. c.	AC-1: 200.000					
	B10 <sub>d</sub> = B10/ratio of dangerous failures			AC-3: 300.000					
	$\lambda$ - Failure rate $\lambda = (0.1 n_{op})/B10$		1/h	AC-1: 0.0002					
				AC-3: 0.000133					
	$\lambda_d$ - Failure rate dangerous $\lambda_d = (0.1 n_{op})/B10_d$		1/h	AC-1: 0.00015					
		AC-3: 0.0001							
Ratio of dangerous failures		%	75						
$n_{op}$ - Operating cycles (operating cycles/h)		op. c./h	300						

### TECHNICAL DATA

	Type	Symbol	Unit	IKA232	IKD232	IKA25	IKD25	IKA432	IKD432
				IKA232-R IKA232-T	IKD232-R IKD232-T	IKA25-R IKA25-T <sup>1)</sup>	IKD25-R IKD25-T <sup>1)</sup>	IKA432-R IKA432-T <sup>1)</sup>	IKD432-R IKD432-T <sup>1)</sup>
Standards				IEC/EN 61095, IEC/EN 60947-4-1, IEC/EN 60947-5-1					
Approvals				CE, EAC		CE, CB, NF, EAC		CE	
Module width				1		2			
Number of poles				2		4			
Degree of protection				IP20 (IP40 when installed in installation box - distribution board)					
Pollution degree				3					
Climatic conditions				95 % relative humidity					
Ambient temperature (open)			°C	-15 ... +55 <sup>4)</sup>					
Storage temperature			°C	-30...+80					
Maximum altitude			m	2000					
U <sub>i</sub> and U <sub>e</sub> is reduced for 1.2 % and I <sub>e</sub> for 0.4 % for every additional 100 m									
Number of contactors or switches side-by-side:									
<40 °C				max. 3					
(40 ... 55) °C				max. 2					
Noise level (operation)			dB	30	20	30	20	30	20
Vibration resistance according to IEC/EN 60068-2-6	a		g	switched off: 2 (Z and X axis) / switched on: 3 (Z axis) and 1 (X axis)					
Shock resistance according to IEC/EN 6068-2-27	a		g	switched off: 10 (Z and X axis) / switched on: 15 (Z axis) and 2 (X axis)					
Maximum operating frequency with no load			op. c./h	3.000					
Mechanical endurance			op. c.	3.000.000	10.000.000	3.000.000	10.000.000	3.000.000	10.000.000
Weight			g	130	130	230	250	230	250
Contact reliability				≥17 V; ≥50 mA					
Minimum distance of open contacts			mm	3,6					
Power dissipation per pole			W	2,5	2,5	2,2	2,2	2,5	2,5
Overload current withstand capability:									
10 s			A	72			68		
Maximum back-up fuse for short-circuit protection gL and gG:									
coordination type 1	I <sub>v</sub>	A		32	32	25	25	32	32
coordination type 2									
Rated insulation voltage	U <sub>i</sub>	V		440					
Rated impulse withstand voltage	U <sub>imp</sub>	kV		4					
Rated operational voltage	U <sub>e</sub>	V		400 <sup>2)3)</sup>		400			
Rated frequency	f	Hz		50/60					
Thermal current	I <sub>th</sub>	A		32		25		32	
Rated operational current for AC-1, AC-7a and AC-21	I <sub>e</sub>	A		32		25		32	
Operational power for AC-1, AC-7a and AC-21:									
single-phase 230 V	P <sub>e</sub>	kW		7		5,4		7	
three-phase 230 V						9		12	
three-phase 400 V						16		21	
Maximum operating frequency for AC-1, AC-7a and AC-21			op. c./h	600					
Electrical endurance for AC-1, AC-7a and AC-21			op. c.	NO: 150.000 / NC: 100.000		200.000		150.000	
Rated operational current for AC-2	I <sub>e</sub>	A		16		14		16	
Operational power for AC-2:									
single-phase 230 V	P <sub>e</sub>	kW		2,4		2		2,4	
three-phase 230 V						3,6		4,1	
three-phase 400 V						6		7,2	
Maximum operating frequency for AC-2			op. c./h	120					
Electrical endurance for AC-2			op. c.	100.000					
Rated operational current for AC-22	I <sub>e</sub>	A		32		25		32	
Operational power for AC-22:									
single-phase 230 V	P <sub>e</sub>	kW		5,9		4,6		5,9	
three-phase 230 V						8		10,2	
three-phase 400 V						13,8		17,7	
Maximum operating frequency for AC-22			op. c./h	300					
Electrical endurance for AC-22			op. c.	50.000					
Rated operational current for AC-3, AC-7b and AC-23	I <sub>e</sub>	A		NO: 9 / NC: 6		8,5			
Operational power for AC-3, AC-7b and AC-23:									
single-phase 230 V	P <sub>e</sub>	kW		NO: 1.3 / NC: 0.75		1.3			
three-phase 230 V						2.2			
three-phase 400 V						4			
Maximum operating frequency for AC-3, AC-7b and AC-23			op. c./h	600					
Electrical endurance for AC-3, AC-7b and AC-23			op. c.	300.000		500.000			

<sup>1)</sup> Available approvals only CE

<sup>2)</sup> Rated operational voltage between two line (phase) conductors

<sup>3)</sup> Rated operational voltage for versions of contacts -10 and -01 is 230 V

<sup>4)</sup> Ambient temperature (open) -25...+55 °C for version with 2NO and 4NO contacts

# Installation Contactors

## up to 32 A



### TECHNICAL DATA

Type	Symbol	Unit	IKA232	IKD232	IKA25	IKD25	IKA432	IKD432
			IKA232-R IKA232-T	IKD232-R IKD232-T	IKA25-R IKA25-T	IKD25-R IKD25-T	IKA432-R IKA432-T	IKD432-R IKD432-T
Rated operational current for AC-5a (at 230 V)	$I_e$	A	13		11.2		13	
Maximum operating frequency for AC-5a		op. c./h	600					
Electrical endurance for AC-5a		op. c.	100.000					
Rated operational current for AC-5b (at 230 V)	$I_e$	A	11		9.7		11	
Maximum operating frequency for AC-5b		op. c./h	600					
Electrical endurance for AC-5b		op. c.	100.000					
Rated operational current for AC-6a (at 230 V)	$I_e$	A	6		2.8		6	
Maximum operating frequency for AC-6a		op. c./h	600					
Electrical endurance for AC-6a		op. c.	100.000					
Switching of capacitors AC-6b and AC-7c (at 230 V)	C	$\mu\text{F}$	40		36		40	
Maximum operating frequency for AC-6b and AC-7c		op. c./h	600					
Electrical endurance for AC-6b and AC-7c		op. c.	100.000					
Rated operational current for DC-1 (L/R $\leq$ 1 ms): 1 pole ... 24 V DC/48 V DC/60 V DC/110 V DC/ 220 V DC 2 poles in series ... 24 V DC/48 V DC/60 V DC/110 V DC/ 220 V DC 3 poles in series ... 24 V DC/48 V DC/60 V DC/110 V DC/ 220 V DC 4 poles in series ... 24 V DC/48 V DC/60 V DC/110 V DC/ 220 V DC	$I_e$	A	32/25/15/6/0.6		25/20/15/6/0.6		32/25/15/6/0.6	
Maximum operating frequency for DC-1		op. c./h	300					
Electrical endurance for DC-1		op. c.	100.000					
Rated operational current for DC-3 (L/R $\leq$ 2 ms): 1 pole ... 24 V DC/48 V DC/60 V DC/110 V DC/ 220 V DC 2 poles in series ... 24 V DC/48 V DC/60 V DC/110 V DC/ 220 V DC 3 poles in series ... 24 V DC/48 V DC/60 V DC/110 V DC/ 220 V DC 4 poles in series ... 24 V DC/48 V DC/60 V DC/110 V DC/ 220 V DC	$I_e$	A	20/10/4/1.3/0.2		15/8/4/1.3/0.2		20/10/4/1.3/0.2	
Maximum operating frequency for DC-3		op. c./h	300					
Electrical endurance for DC-3		op. c.	100.000					
Rated operational current for DC-5 (L/R $\leq$ 7.5 ms): 1 pole ... 24 V DC/48 V DC/60 V DC/110 V DC/ 220 V DC 2 poles in series ... 24 V DC/48 V DC/60 V DC/110 V DC/ 220 V DC 3 poles in series ... 24 V DC/48 V DC/60 V DC/110 V DC/ 220 V DC 4 poles in series ... 24 V DC/48 V DC/60 V DC/110 V DC/ 220 V DC	$I_e$	A	18/6/3/0.5/0.1		15/5/3/0.5/0.1		18/6/3/0.5/0.1	
Maximum operating frequency for DC-5		op. c./h	300					
Electrical endurance for DC-5		op. c.	100.000					
Terminal capacity: rigid (solid and stranded)	S	mm <sup>2</sup>	1 ... 10					
flexible			1 ... 6					
Length of removed wire insulation		mm	9					
Screw			M3.5					
Screw head			PZ1					
Tightening torque		Nm	1.2					
Contact reliability			$\geq 17 \text{ V}; \geq 50 \text{ mA}$					
Minimum distance of open contacts		mm	3.6					
Power dissipation per pole		W	2.5	2.5	2.2	2.2	2.5	2.5
Overload current withstand capability: 10 s		A	72			68		
Maximum back-up fuse for short-circuit protection gL and gG: coordination type 1 coordination type 2	$I_v$	A	32	32	25	25	32	32
Rated insulation voltage	$U_i$	V	440					
Rated impulse withstand voltage	$U_{imp}$	kV	4					
Rated operational voltage	$U_e$	V	230/400					
Rated frequency	f	Hz	50/60					
Thermal current	$I_{th}$	A	32		25		32	
Rated operational current for AC-15: single-phase 230 V single-phase 400 V	$I_e$	A	6 4					
Maximum operating frequency for AC-15		op. c./h	600					
Electrical endurance for AC-15		op. c.	300.000			500.000		
Rated operational current for DC-13: 1 pole ... 24 V DC/48 V DC/60 V DC/110 V DC/ 220 V DC 2 poles in series ... 24 V DC/48 V DC/60 V DC/110 V DC/ 220 V DC 3 poles in series ... 24 V DC/48 V DC/60 V DC/110 V DC/ 220 V DC 4 poles in series ... 24 V DC/48 V DC/60 V DC/110 V DC/ 220 V DC	$I_e$	A	6/4/1/0.3/0.05 6/6/4/1/0.1 6/6/6/3/1 6/6/6/4/2					



### TECHNICAL DATA

	Type	Symbol	Unit	IKA232	IKD232	IKA25	IKD25	IKA432	IKD432
				IKA232-R IKA232-T	IKD232-R IKD232-T	IKA25-R IKA25-T	IKD25-R IKD25-T	IKA432-R IKA432-T	IKD432-R IKD432-T
AUXILIARY CIRCUIT	Maximum operating frequency for DC-13		op. c./h	300					
	Electrical endurance for DC-13		op. c.	200.000					
	Terminal capacity: rigid (solid and stranded)	S	mm <sup>2</sup>	1 ... 10					
	flexible			1 ... 6					
	Length of removed wire insulation		mm	9					
	Screw			M3.5					
	Screw head		mm	PZ1					
	Tightening torque			1.2					
COIL	Range of control voltage for switch-on	U <sub>c</sub>	%	85 ... 110					
	Range of control voltage for drop out	U <sub>c</sub>	%	AC: 75 ... 20 / DC: 75 ... 10 (where is applicable)					
	Kind of voltage			AC	AC/DC	AC	AC/DC	AC	AC/DC
	Standard control voltages	U <sub>c</sub>	V	12, 24, 48, 120, 230		12, 24, 48 120, 230, 400	12, 24, 48 120, 230	12, 24, 48, 120, 230, 400	12, 24, 48, 120, 230
	Frequency of AC control voltage	f	Hz	50/60	40 ... 500	50/60	40 ... 500	50/60	40 ... 500
	Control mode			remote control with U <sub>c</sub> / manual control only for types with -R and -T					
	Impulse duration of control voltage: minimum			permanent					
	maximum			permanent					
	Minimum duration between two impulses of control voltage		ms	AC: 150 / DC: 500 (where is applicable)					
	Surge immunity withstand voltage 1,2/50 μs acc. to standard IEC/EN 61000-4-5		kV	2					
	Coil consumption: switch-on		VA/W	12/10	2.1/2.1	33/25	2.6/2.6 <sup>1)</sup>	33/25	2.6/2.6 <sup>1)</sup>
	operation	2.8/1.2		2.1/2.1	5.5/1.6	2.6/2.6 <sup>1)</sup>	5.5/1.6	2.6/2.6 <sup>1)</sup>	
	Delays: make		ms	15 ... 25	15 ... 45	10 ... 30	15 ... 45	10 ... 30	15 ... 45
	brake			10 ... 30	20 ... 50	10 ... 30	20 ... 70	10 ... 30	20 ... 70
	Terminal capacity: rigid (solid and stranded)		mm <sup>2</sup>	1 ... 2.5					
	flexible			1 ... 2.5					
	Length of removed wire insulation		mm	7					
	Screw			M3					
	Screw head			PZ1					
	Tightening torque		Nm	0.6					
SAFETY	MTTF - Mean time to failure		h	AC-1: 3.750		AC-1: 5.000		AC-1: 3.750	
	MTTF = 1/λ = B10/(0.1 n <sub>op</sub> )			AC-3: 7.500		AC-3: 12.500			
	MTTF <sub>d</sub> - Mean time to failure dangerous		h	AC-1: 5.000		AC-1: 6.666		AC-1: 5.000	
	MTTF <sub>d</sub> = 1/λ <sub>d</sub> = B10 <sub>d</sub> /(0.1 n <sub>op</sub> )			AC-3: 10.000		AC-3: 16.666			
	B10 - Number of operating cycles until 10 % of devices fail		op. c.	AC-1: 112.500 for NO		AC-1: 150.000		AC-1: 112.500	
				AC-3: 225.000		AC-3: 375.000			
	B10 <sub>d</sub> - Number of operating cycles until 10 % of device dangerous		op. c.	AC-1: 150.000 for NO		AC-1: 200.000		AC-1: 150.000	
	B10 <sub>d</sub> = B10/ratio of dangerous failures			AC-3: 300.000		AC-3: 500.000			
	λ - Failure rate		1/h	AC-1: 0.000266 for NO		AC-1: 0.0002		AC-1: 0.000266	
	λ = (0.1 n <sub>op</sub> )/B10			AC-3: 0.000133		AC-3: 0.00008			
	λ <sub>d</sub> - Failure rate dangerous		1/h	AC-1: 0.0002 for NO		AC-1: 0.00015		AC-1: 0.0002	
	λ <sub>d</sub> = (0.1 n <sub>op</sub> )/B10 <sub>d</sub>			AC-3: 0.0001		AC-3: 0.00006			
Ratio of dangerous failures		%	75						
n <sub>op</sub> - Operating cycles (operating cycles/h)		op. c./h	300						

<sup>1)</sup> Coil consumption for version -04 is 3.8 VA/3.8 W

# Installation Contactors

## up to 63 A



### TECHNICAL DATA

Type	Symbol	Unit	IKA40	IK40	IKA63	IK63
Standards			IEC/EN 61095, IEC/EN 60947-4-1, IEC/EN 60947-5-1			
Approvals			CE, CB, NF, EAC			
Module width			3			
Number of poles			4			
Degree of protection			IP20 (IP40 when installed in installation box - distribution board)			
Pollution degree			3			
Climatic conditions			95 % relative humidity			
Ambient temperature (open)		°C	-15 ... +55 <sup>3)</sup>			
Storage temperature		°C	-30... +80			
Maximum altitude		m	2000			
U <sub>i</sub> and U <sub>e</sub> is reduced for 1.2 % and I <sub>e</sub> for 0.4 % for every additional 100 m						
Number of contactors or switches side-by-side:						
<40 °C			no limitation	max. 3	no limitation	max. 3
(40 ... 55) °C			no limitation	max. 2	no limitation	max. 2
Noise level (operation)		dB	30	20	30	20
Vibration resistance according to IEC/EN 60068-2-6	a	g	switched off: 2 (Z and X axis) / switched on: 3 (Z axis) and 1 (X axis)			
Shock resistance according to IEC/EN 6068-2-27	a	g	switched off: 10 (Z and X axis) / switched on: 15 (Z axis) and 2 (X axis)			
Maximum operating frequency with no load		op. c./h	3.000			
Mechanical endurance		op. c.	3.000.000	10.000.000	3.000.000	10.000.000
Weight		g	350	420	350	420
Contact reliability			≥17 V; ≥50 mA			
Minimum distance of open contacts		mm	3.6			
Power dissipation per pole		W	4	4	8	8
Overload current withstand capability:						
10 s		A	176		240	
Maximum back-up fuse for short-circuit protection gL and gG:						
coordination type 1	I <sub>v</sub>	A	63	63	80	80
coordination type 2			40	40	63	63
Rated insulation voltage	U <sub>i</sub>	V	440			
Rated impulse withstand voltage	U <sub>imp</sub>	kV	6			
Rated operational voltage	U <sub>e</sub>	V	400			
Rated frequency	f	Hz	50/60			
Thermal current	I <sub>th</sub>	A	40		63	
Rated operational current for AC-1, AC-7a and AC-21	I <sub>e</sub>	A	40		63 <sup>1)</sup>	
Operational power for AC-1, AC-7a and AC-21:						
single-phase 230 V	P <sub>e</sub>	kW	8.7		13.3 <sup>2)</sup>	
three-phase 230 V			16		24 <sup>2)</sup>	
three-phase 400 V			26		40 <sup>2)</sup>	
Maximum operating frequency for AC-1, AC-7a and AC-21		op. c./h	600			
Electrical endurance for AC-1, AC-7a and AC-21		op. c.	100.000			
Rated operational current for AC-2	I <sub>e</sub>	A	25		32	
Operational power for AC-2:						
single-phase 230 V	P <sub>e</sub>	kW	3.7		4.8	
three-phase 230 V			6.5		8.3	
three-phase 400 V			11.2		14.4	
Maximum operating frequency for AC-2		op. c./h	120			
Electrical endurance for AC-2		op. c.	50.000			
Rated operational current for AC-22	I <sub>e</sub>	A	40		63	
Operational power for AC-22:						
single-phase 230 V	P <sub>e</sub>	kW	7.4		11.6	
three-phase 230 V			12.7		20.1	
three-phase 400 V			22.2		34.9	
Maximum operating frequency for AC-22		op. c./h	300			
Electrical endurance for AC-22		op. c.	50.000			
Rated operational current for AC-3, AC-7b and AC-23	I <sub>e</sub>	A	22		30	
Operational power for AC-3, AC-7b and AC-23:						
single-phase 230 V	P <sub>e</sub>	kW	3.7		5	
three-phase 230 V			5.5		8.5	
three-phase 400 V			11		15	
Maximum operating frequency for AC-3, AC-7b and AC-23		op. c./h	600			
Electrical endurance for AC-3, AC-7b and AC-23		op. c.	150.000			

<sup>1)</sup> I<sub>e</sub> (AC-1) for IK63-04 is 50 A

<sup>2)</sup> Rated power (AC-1) for IK63-04:  
single-phase 230 V = 10.9 kW  
three-phase 230 V = 18.9 kW  
three-phase 400 V = 32.9 kW

<sup>3)</sup> Ambient temperature (open) -25...+55 °C for version with 4NO contacts

### TECHNICAL DATA

Type	Symbol	Unit	IKA40	IK40	IKA63	IK63
Rated operational current for AC-5a (at 230 V)	$I_e$	A	20		32	
Maximum operating frequency for AC-5a		op. c./h	600			
Electrical endurance for AC-5a		op. c.	100.000			
Rated operational current for AC-5b (at 230 V)	$I_e$	A	17.6		22	
Maximum operating frequency for AC-5b		op. c./h	600			
Electrical endurance for AC-5b		op. c.	100.000			
Rated operational current for AC-6a (at 230 V)	$I_e$	A	10.8		17.2	
Maximum operating frequency for AC-6a		op. c./h	600			
Electrical endurance for AC-6a		op. c.	100.000			
Switching of capacitors AC-6b and AC-7c (at 230 V)	C	$\mu\text{F}$	220		330	
Maximum operating frequency for AC-6b and AC-7c		op. c./h	600			
Electrical endurance for AC-6b and AC-7c		op. c.	100.000			
Rated operational current for DC-1 (L/R $\leq$ 1 ms): 1 pole ... 24 V DC/48 V DC/60 V DC/110 V DC/ 220 V DC 2 poles in series ... 24 V DC/48 V DC/60 V DC/110 V DC/ 220 V DC 3 poles in series ... 24 V DC/48 V DC/60 V DC/110 V DC/ 220 V DC 4 poles in series ... 24 V DC/48 V DC/60 V DC/110 V DC/ 220 V DC	$I_e$	A	40/25/18/4/1.2		63/26/20/4/1.2	
			40/38/32/10/8		63/42/34/10/8	
			40/40/40/30/20		63/63/60/35/30	
			40/40/40/40/40		63/63/63/63/63	
Maximum operating frequency for DC-1		op. c./h	300			
Electrical endurance for DC-1		op. c.	100.000			
Rated operational current for DC-3 (L/R $\leq$ 2 ms): 1 pole ... 24 V DC/48 V DC/60 V DC/110 V DC/ 220 V DC 2 poles in series ... 24 V DC/48 V DC/60 V DC/110 V DC/ 220 V DC 3 poles in series ... 24 V DC/48 V DC/60 V DC/110 V DC/ 220 V DC 4 poles in series ... 24 V DC/48 V DC/60 V DC/110 V DC/ 220 V DC	$I_e$	A	22/10/5/1.5/0.3		25/11/5/1.5/0.3	
			40/20/16/5/1		45/22/18/5/1	
			40/40/32/15/4		63/45/35/18/5	
			40/40/40/40/10		63/63/63/63/10	
Maximum operating frequency for DC-3		op. c./h	300			
Electrical endurance for DC-3		op. c.	100.000			
Rated operational current for DC-5 (L/R $\leq$ 7.5 ms): 1 pole ... 24 V DC/48 V DC/60 V DC/110 V DC/ 220 V DC 2 poles in series ... 24 V DC/48 V DC/60 V DC/110 V DC/ 220 V DC 3 poles in series ... 24 V DC/48 V DC/60 V DC/110 V DC/ 220 V DC 4 poles in series ... 24 V DC/48 V DC/60 V DC/110 V DC/ 220 V DC	$I_e$	A	20/8/4/1/0.2		25/10/5/1/0.2	
			40/18/14/5/0.8		45/20/15/5/0.8	
			40/40/28/12/3		63/44/30/15/4	
			40/40/40/35/8		63/63/60/45/10	
Maximum operating frequency for DC-5		op. c./h	300			
Electrical endurance for DC-5		op. c.	100.000			
Terminal capacity: rigid (solid and stranded) flexible	S	mm <sup>2</sup>	1.5 ... 25 1.5 ... 16			
Length of removed wire insulation		mm	10			
Screw			M5			
Screw head			PZ2			
Tightening torque		Nm	3.5			
Contact reliability			$\geq 17 \text{ V}; \geq 50 \text{ mA}$			
Minimum distance of open contacts		mm	3.6			
Power dissipation per pole		W	4	4	8	8
Overload current withstand capability: 10 s		A	176		240	
Maximum back-up fuse for short-circuit protection gL and gG: coordination type 1 coordination type 2	$I_v$	A	63 40	63 40	80 63	80 63
Rated insulation voltage	$U_i$	V	440			
Rated impulse withstand voltage	$U_{imp}$	kV	4			
Rated operational voltage	$U_e$	V	230/400			
Rated frequency	f	Hz	50/60			
Thermal current	$I_{th}$	A	40		63	
Rated operational current for AC-15: single-phase 230 V single-phase 400 V	$I_e$	A	6 4			
Maximum operating frequency for AC-15		op. c./h	1.200			
Electrical endurance for AC-15		op. c.	150.000			
Rated operational current for DC-13: 1 pole ... 24 V DC/48 V DC/60 V DC/110 V DC/ 220 V DC 2 poles in series ... 24 V DC/48 V DC/60 V DC/110 V DC/ 220 V DC 3 poles in series ... 24 V DC/48 V DC/60 V DC/110 V DC/ 220 V DC 4 poles in series ... 24 V DC/48 V DC/60 V DC/110 V DC/ 220 V DC	$I_e$	A	6/4/1/0.3/0.05 6/6/4/1/0.1 6/6/6/3/1 6/6/6/4/2			

# Installation Contactors

## up to 63 A



### TECHNICAL DATA

Type		Symbol	Unit	IKA40	IK40	IKA63	IK63
AUXILIARY CIRCUIT	Maximum operating frequency for DC-13		op. c./h	300			
	Electrical endurance for DC-13		op. c.	200.000			
	Terminal capacity: rigid (solid and stranded)	S	mm <sup>2</sup>	1.5 ... 25			
	flexible			1.5 ... 16			
	Length of removed wire insulation		mm	10			
	Screw			M5			
	Screw head		mm	PZ2			
	Tightening torque			3.5			
COIL	Range of control voltage for switch-on	U <sub>c</sub>	%	85 ... 110			
	Range of control voltage for drop out	U <sub>c</sub>	%	AC: 75 ... 20 / DC: 75 ... 10 (where is applicable)			
	Kind of voltage			AC	AC/DC	AC	AC/DC
	Standard control voltages	U <sub>c</sub>	V	12, 24, 48, 120, 230, 400	12, 24, 48, 120, 230	12, 24, 48, 120, 230, 400	12, 24, 48, 120, 230
	Frequency of AC control voltage	f	Hz	50/60	40 ... 500	50/60	40 ... 500
	Control mode			remote control with U <sub>c</sub> / manual control only for types with -R			
	Impulse duration of control voltage: minimum			permanent			
	maximum			permanent			
	Minimum duration between two impulses of control voltage		ms	AC: 150 / DC: 500 (where is applicable)			
	Surge immunity withstand voltage 1.2/50 μs acc. to standard IEC/EN 61000-4-5		kV	2			
	Coil consumption: switch-on	VA/W		15.4/6	5/5 <sup>1)</sup>	15.4/6	5/5 <sup>1)</sup>
	operation			7.7/3	5/5 <sup>1)</sup>	7.7/3	5/5 <sup>1)</sup>
	Delays: make		ms	10 ... 20	15 ... 20	10 ... 20	15 ... 20
	brake			10 ... 15	35 ... 45	10 ... 15	35 ... 45
	Terminal capacity: rigid (solid and stranded)		mm <sup>2</sup>	1 ... 2.5			
	flexible			1 ... 2.5			
	Length of removed wire insulation		mm	8			
	Screw			M3			
	Screw head			PZ1			
	Tightening torque		Nm	0.6			
SAFETY	MTTF - Mean time to failure MTTF = 1/λ = B10/(0.1 n <sub>op</sub> )		h	AC-1: 2.500 AC-3: 3.750			
	MTTF <sub>d</sub> - Mean time to failure dangerous MTTF <sub>d</sub> = 1/λ <sub>d</sub> = B10 <sub>d</sub> /(0.1 n <sub>op</sub> )		h	AC-1: 3.333 AC-3: 5.000			
	B10 - Number of operating cycles until 10 % of devices fail		op. c.	AC-1: 75.000 AC-3: 112.500			
	B10 <sub>d</sub> - Number of operating cycles until 10 % of device dangerous		op. c.	AC-1: 100.000 AC-3: 150.000			
	B10 <sub>d</sub> = B10/ratio of dangerous failures			AC-1: 0.0004 AC-3: 0.000266			
	λ - Failure rate λ = (0.1 n <sub>op</sub> )/B10		1/h	AC-1: 0.0003 AC-3: 0.0002			
	λ <sub>d</sub> - Failure rate dangerous λ <sub>d</sub> = (0.1 n <sub>op</sub> )/B10 <sub>d</sub>		1/h	AC-1: 0.0003 AC-3: 0.0002			
	Ratio of dangerous failures		%	75			
	n <sub>op</sub> - Operating cycles (operating cycles/h)		op. c./h	300			

<sup>1)</sup> Coil consumption for version -22 and -04 is 6.1 VA/6.1 W

### TECHNICAL DATA

Type	Symbol	Unit	IKA220	IKD220	IKA425	IKD425
Standards			UL 60947-4-1A, C22.2 No. 60947-4-1A-07, IEC/EN 61095, IEC/EN 60947-4-1			
Approvals			CE, UL, CSA			
Module width			1		2	
Number of poles			2		4	
Degree of protection			IP20 (IP40 when installed in installation box - distribution board)			
Pollution degree			3			
Ambient temperature (closed)			5 °F ... 104 °F / -5 °C ... +40 °C <sup>5)</sup>			
Storage temperature			-22 °F ... 176 °F / -30 °C ... +80 °C			
Maximum altitude		m	2000			
U <sub>i</sub> and U <sub>e</sub> is reduced for 1.2 % and I <sub>e</sub> for 0.4 % for every additional 100 m						
Number of contactors or switches side-by-side:			no limitation			
<40 °C						
(40 ... 55) °C						
Noise level (operation)		dB	30	20	30	20
Vibration resistance according to IEC/EN 60068-2-6	a	g	switched off: 2 (Z and X axis) / switched on: 3 (Z axis) and 1 (X axis)			
Shock resistance according to IEC/EN 6068-2-27	a	g	switched off: 10 (Z and X axis) / switched on: 15 (Z axis) and 2 (X axis)			
Maximum operating frequency with no load		op. c./h	3.000			
Mechanical endurance		op. c.	3.000.000	10.000.000	3.000.000	10.000.000
Weight		g	130	130	230	250
Contact reliability			≥17 V; ≥50 mA			
Minimum distance of open contacts			0.118 in / 3.6 mm			
Power dissipation per pole		W	1.7	1.7	2	2
Overload current withstand capability:			72		68	
10 s	A					
Maximum back-up fuse for short-circuit protection gL and gG:						
coordination type 1	I <sub>v</sub>	A			25	25
coordination type 2			20	20		
Maximum back-up fuse for short-circuit protection KS acc. to UL and CSA	I <sub>v</sub>	A	20	20	25	25
Rated insulation voltage	U <sub>i</sub>	V	440			
Rated impulse withstand voltage	U <sub>imp</sub>	kV	4			
Rated operational voltage	U <sub>e</sub>	V	440 <sup>1)2)</sup>	240 <sup>3)</sup>	400/480 <sup>4)</sup>	
Rated frequency	f	Hz	50/60			
Thermal current	I <sub>th</sub>	A	20		25	
Rated operational current for AC-1, AC-7a and AC-21	I <sub>e</sub>	A	20		20	
Operational power for AC-1, AC-7a and AC-21:						
single-phase 230 V	P <sub>e</sub>	kW	4		5,4	
three-phase 230 V					9	
three-phase 400 V					16	
Maximum operating frequency for AC-1, AC-7a and AC-21		op. c./h	600			
Electrical endurance for AC-1, AC-7a and AC-21		op. c.	200.000			
Rated operational current for AC-2	I <sub>e</sub>	A	12		14	
Operational power for AC-2:						
single-phase 230 V	P <sub>e</sub>	kW	1.8		2	
three-phase 230 V					3,6	
three-phase 400 V					6	
Maximum operating frequency for AC-2		op. c./h	120			
Electrical endurance for AC-2		op. c.	100.000			
Rated operational current for AC-22	I <sub>e</sub>	A	20		25	
Operational power for AC-22:						
single-phase 230 V	P <sub>e</sub>	kW	3.7		4,6	
three-phase 230 V					8	
three-phase 400 V					13,8	
Maximum operating frequency for AC-22		op. c./h	300			
Electrical endurance for AC-22		op. c.	50.000			
Rated operational current for AC-3, AC-7b and AC-23	I <sub>e</sub>	A	NO: 9 / NC: 6		8,5	
Operational power for AC-3, AC-7b and AC-23:						
single-phase 230 V	P <sub>e</sub>	kW	NO: 1.3 / NC: 0.75		1,3	
three-phase 230 V					2,2	
three-phase 400 V					4	
Maximum operating frequency for AC-3, AC-7b and AC-23		op. c./h	600			
Electrical endurance for AC-3, AC-7b and AC-23		op. c.	300.000		500.000	

<sup>1)</sup> Rated operational voltage between two line (phase) conductors

<sup>2)</sup> Rated operational voltage for versions of contacts -10 and -01 is 230 V

<sup>3)</sup> Rated voltage 240 V valid in acc. to UL and CSA

<sup>4)</sup> Rated voltage 480 V valid in acc. to UL and CSA

<sup>5)</sup> Ambient temperature (open) -13 ... 104 °F / -25 ... +40 °C for version with 2NO and 4NO contacts

# Installation Contactors UL/CSA

## up to 25 A



### TECHNICAL DATA

Type	Symbol	Unit	IKA220	IKD220	IKA425	IKD425
Rated motor power acc. to standards UL and CSA:	P <sub>e</sub>	HP	1/3	1/3	1/3	1/3
single-phase 120 V			3/4	3/4	3/4	3/4
single-phase 208 V			1	1	1	1
single-phase 240 V					1	1
three-phase 120 V					2	2
three-phase 208 V					3	3
three-phase 240 V					5	5
Maximum operating frequency for motors acc. to UL and CSA		op. c./h	360			
Electrical endurance for motors according to UL and CSA		op. c.	300.000		500.000	
General use according to standards UL and CSA:	I <sub>e</sub>	A	20	20		
single-phase 240 V					25	25
three-phase 480 V						
Maximum operating frequency for general use acc. to UL and CSA		op. c./h	360			
Electrical endurance for general use acc. to UL and CSA		op. c.	200.000			
Switching of discharge lamps acc. to standards UL and CSA:	I <sub>e</sub>	A	20	20		
single-phase 240 V - standard ballast					25	25
three-phase 480 V - standard ballast						
Maximum operating frequency for discharge lamps acc. to UL and CSA		op. c./h	360			
Electrical endurance for discharge lamps acc. to UL and CSA		op. c.	100.000			
Rated operational current for AC-5a (at 230 V)	I <sub>e</sub>	A	8.8		11.2	
Maximum operating frequency for AC-5a		op. c./h	600			
Electrical endurance for AC-5a		op. c.	100.000			
Rated operational current for AC-5b (at 230 V)	I <sub>e</sub>	A	8.8		9.7	
Maximum operating frequency for AC-5b		op. c./h	600			
Electrical endurance for AC-5b		op. c.	100.000			
Rated operational current for AC-6a (at 230 V)	I <sub>e</sub>	A	4		4.8	
Maximum operating frequency for AC-6a		op. c./h	600			
Electrical endurance for AC-6a		op. c.	100.000			
Switching of capacitors AC-6b and AC-7c (at 230 V)	C	µF	30		36	
Maximum operating frequency for AC-6b and AC-7c		op. c./h	600			
Electrical endurance for AC-6b and AC-7c		op. c.	100.000			
Rated operational current for DC-1 (L/R ≤ 1 ms):	I <sub>e</sub>	A	20/15/10/6/0.6		25/20/15/6/0.6	
1 pole ... 24 V DC/48 V DC/60 V DC/110 V DC/ 220 V DC			25/18/15/10/6		25/25/20/10/6	
2 poles in series ... 24 V DC/48 V DC/60 V DC/110 V DC/ 220 V DC			25/25/25/20/15		25/25/25/20/15	
3 poles in series ... 24 V DC/48 V DC/60 V DC/110 V DC/ 220 V DC			25/25/25/20/15		25/25/25/20/15	
4 poles in series ... 24 V DC/48 V DC/60 V DC/110 V DC/ 220 V DC						
Maximum operating frequency for DC-1		op. c./h	300			
Electrical endurance for DC-1		op. c.	100.000			
Rated operational current for DC-3 (L/R ≤ 2 ms):	I <sub>e</sub>	A	10/5/2/1/0.1		15/8/4/1.3/0.2	
1 pole ... 24 V DC/48 V DC/60 V DC/110 V DC/ 220 V DC			20/10/8/4/0.4		25/10/8/4/0.4	
2 poles in series ... 24 V DC/48 V DC/60 V DC/110 V DC/ 220 V DC			25/25/25/15/3		25/25/25/15/3	
3 poles in series ... 24 V DC/48 V DC/60 V DC/110 V DC/ 220 V DC			25/25/25/20/8		25/25/25/20/8	
4 poles in series ... 24 V DC/48 V DC/60 V DC/110 V DC/ 220 V DC						
Maximum operating frequency for DC-3		op. c./h	300			
Electrical endurance for DC-3		op. c.	100.000			
Rated operational current for DC-5 (L/R ≤ 7.5 ms):	I <sub>e</sub>	A	10/4/1/0.3/0.06		15/5/3/0.5/0.1	
1 pole ... 24 V DC/48 V DC/60 V DC/110 V DC/ 220 V DC			20/8/6/2/0.2		25/15/10/4/0.4	
2 poles in series ... 24 V DC/48 V DC/60 V DC/110 V DC/ 220 V DC			25/25/20/12/2		25/25/20/12/2	
3 poles in series ... 24 V DC/48 V DC/60 V DC/110 V DC/ 220 V DC			25/25/25/15/5		25/25/25/15/5	
4 poles in series ... 24 V DC/48 V DC/60 V DC/110 V DC/ 220 V DC						
Maximum operating frequency for DC-5		op. c./h	300			
Electrical endurance for DC-5		op. c.	100.000			
Terminal capacity:	S		16 ... 10 AWG / 1 ... 10 mm <sup>2</sup>			
rigid (solid and stranded)			16 ... 8 AWG / 1 ... 6 mm <sup>2</sup>			
flexible			0.354 in / 9 mm			
Length of removed wire insulation			0.354 in / 9 mm			
Screw			M3.5			
Screw head			PZ1			
Tightening torque			10.62 lb-in / 1.2 Nm			
Contact reliability			≥17 V; ≥50 mA			
Minimum distance of open contacts			0.118 in / 3.6 mm			
Power dissipation per pole		W	1.7		2.2	
Overload current withstand capability:			72		68	
10 s						
Maximum back-up fuse for short-circuit protection gL and gG:	I <sub>v</sub>	A			25	
coordination type 1			20		20	
coordination type 2						

### TECHNICAL DATA

Type	Symbol	Unit	IKA220	IKD220	IKA425	IKD425
Maximum back-up fuse for short-circuit protection K5 acc. to UL and CSA	$U_i$	V	20	20	25	25
Rated insulation voltage	$U_i$	V	440			
Rated impulse withstand voltage	$U_{imp}$	kV	4			
Rated operational voltage	$U_e$	V	230/400			
Rated frequency	f	Hz	50/60			
Thermal current	$I_{th}$	A	20		25	
Rated operational current for AC-15: single-phase 230 V single-phase 400 V	$I_e$	A	6 4			
Maximum operating frequency for AC-15		op. c./h	600			
Electrical endurance for AC-15		op. c.	300.000		500.000	
Switching of auxiliary loads according to standard UL and CSA			B300, P300			
Maximum operating frequency for auxiliary loads according to UL and CSA		op. c./h	360			
Electrical endurance for auxiliary loads according to UL and CSA		op. c.	100.000			
Rated operational current for DC-13: 1 pole ... 24 V DC/48 V DC/60 V DC/110 V DC/ 220 V DC 2 poles in series ... 24 V DC/48 V DC/60 V DC/110 V DC/ 220 V DC 3 poles in series ... 24 V DC/48 V DC/60 V DC/110 V DC/ 220 V DC 4 poles in series ... 24 V DC/48 V DC/60 V DC/110 V DC/ 220 V DC	$I_e$	A	6/4/1/0.3/0.05 6/6/4/1/0.1 6/6/6/3/1 6/6/6/4/2			
Maximum operating frequency for DC-13		op. c./h	300			
Electrical endurance for DC-13		op. c.	200.000			
Terminal capacity: rigid (solid and stranded) flexible	S		16...10 AWG / 1...10 mm <sup>2</sup> 16... 8 AWG / 1...6 mm <sup>2</sup>			
Length of removed wire insulation			0.354 in / 9 mm			
Screw			M3.5			
Screw head			PZ1			
Tightening torque			10.62 lb-in / 1.2 Nm			
Range of control voltage for switch-on	$U_c$	%	85 ... 110			
Range of control voltage for drop out	$U_c$	%	AC: 75 ... 20 / DC: 75 ... 10 (where is applicable)			
Kind of voltage			AC	AC/DC	AC	AC/DC
Standard control voltages	$U_c$	V	12, 24, 48, 110, 120, 127, 208, 230, 240			
Frequency of AC control voltage	f	Hz	50/60			
Control mode			remote control with $U_c$			
Impulse duration of control voltage: minimum maximum			permanent permanent			
Minimum duration between two impulses of control voltage		ms	AC: 150 / DC: 500 (where is applicable)			
Surge immunity withstand voltage 1.2/50 $\mu$ s acc. to standard IEC/EN 61000-4-5		kV	2			
Coil consumption: switch-on operation		VA/W	12/10 2.8/1.2	2.1/2.1 2.1/2.1	33/25 5.5/1.6	2.6/2.6 <sup>1)</sup> 2.6/2.6 <sup>1)</sup>
Delays: make brake		ms	15 ... 25 10 ... 30	15 ... 45 20 ... 50	10 ... 30 10 ... 30	15 ... 45 20 ... 70
Terminal capacity: rigid (solid and stranded) flexible			16 ... 14 AWG / 1 ... 2.5 mm <sup>2</sup> 16 ... 14 AWG / 1 ... 2.5 mm <sup>2</sup>			
Length of removed wire insulation			0.276 in / 7 mm			
Screw			M3			
Screw head			PZ1			
Tightening torque			5.31 lb-in / 0.6 Nm			
MTTF - Mean time to failure MTTF = $1/\lambda = B10/(0.1 n_{op})$		h	General Use: 4.166 Motor: 6.250   Motor: 10.416			
MTTF <sub>d</sub> - Mean time to failure dangerous MTTF <sub>d</sub> = $1/\lambda_d = B10_d/(0.1 n_{op})$		h	General Use: 5.555 Motor: 8.333   Motor: 13.888			
B10 - Number of operating cycles until 10 % of devices fail		op. c.	General Use: 150.000 Motor: 225.000   Motor: 375.000			
B10 <sub>d</sub> - Number of operating cycles until 10% of device dangerous B10 <sub>d</sub> = B10/ratio of dangerous failures		op. c.	General Use: 200.000 Motor: 300.000   Motor: 500.000			
$\lambda$ - Failure rate $\lambda = (0.1 n_{op})/B10$		1/h	General Use: 0.00024 Motor: 0.00016   Motor: 0.000096			
$\lambda_d$ - Failure rate dangerous $\lambda_d = (0.1 n_{op})/B10_d$		1/h	General Use: 0.00018 Motor: 0.00012   Motor: 0.000072			
Ratio of dangerous failures		%	75			
$n_{op}$ - Operating cycles (operating cycles/h)		op. c./h	360			

<sup>1)</sup> Coil consumption for contact version -04 is 3.8 VA / 3.8 W

# Installation Contactors UL/CSA up to 63 A



## TECHNICAL DATA

Type	Symbol	Unit	IKA440	IKD440	IKA463	IKD463
Standards			UL 60947-4-1A, C22.2 No. 60947-4-1A-07, IEC/EN 61095, IEC/EN 60947-4-1			
Approvals			CE, UL, CSA			
Module width			3			
Number of poles			4			
Degree of protection			IP20 (IP40 when installed in installation box - distribution board)			
Pollution degree			3			
Ambient temperature (open)			1)		2)	
Storage temperature			-22 °F ... 176 °F / -30 °C ... +80 °C			
Maximum altitude		m	2000			
U <sub>i</sub> and U <sub>e</sub> is reduced for 1.2 % and I <sub>e</sub> for 0.4 % for every additional 100 m						
Number of contactors or switches side-by-side:			no limit	max. 3	no limit	max. 3
<40 °C						
(40 ... 55) °C						
Noise level (operation)		dB	30	20	30	20
Vibration resistance according to IEC/EN 60068-2-6	a	g	switched off: 2 (Z and X axis) / switched on: 3 (Z axis) and 1 (X axis)			
Shock resistance according to IEC/EN 6068-2-27	a	g	switched off: 10 (Z and X axis) / switched on: 15 (Z axis) and 2 (X axis)			
Maximum operating frequency with no load		op. c./h	3.000			
Mechanical endurance		op. c.	3.000.000	10.000.000	3.000.000	10.000.000
Weight		g	350	420	350	420
Contact reliability			≥17 V; ≥50 mA			
Minimum distance of open contacts			0.118 in / 3.6 mm			
Power dissipation per pole		W	4	4	8	8
Overload current withstand capability:			176		240	
10 s		A				
Maximum back-up fuse for short-circuit protection gL and gG:						
coordination type 1	I <sub>v</sub>	A	63	63	80	80
coordination type 2			40	40	63	63
Maximum back-up fuse for short-circuit protection KS acc. to UL and CSA	I <sub>v</sub>	A	60	60	70	70
Rated insulation voltage	U <sub>i</sub>	V	440			
Rated impulse withstand voltage	U <sub>imp</sub>	kV	4			
Rated operational voltage	U <sub>e</sub>	V	400/480 <sup>3)</sup>			
Rated frequency	f	Hz	50/60			
Thermal current	I <sub>th</sub>	A	40		63	
Rated operational current for AC-1, AC-7a and AC-21	I <sub>e</sub>	A	40		63	
Operational power for AC-1, AC-7a and AC-21:						
single-phase 230 V	P <sub>e</sub>	kW	8.7		13.3	
three-phase 230 V			16		24	
three-phase 400 V			26		40	
Maximum operating frequency for AC-1, AC-7a and AC-21		op. c./h	600			
Electrical endurance for AC-1, AC-7a and AC-21		op. c.	100.000			
Rated operational current for AC-2	I <sub>e</sub>	A	25		32	
Operational power for AC-2:						
single-phase 230 V	P <sub>e</sub>	kW	3.7		4.8	
three-phase 230 V			6.5		8.3	
three-phase 400 V			11.2		14.4	
Maximum operating frequency for AC-2		op. c./h	120			
Electrical endurance for AC-2		op. c.	50.000			
Rated operational current for AC-22	I <sub>e</sub>	A	40		63	
Operational power for AC-22:						
single-phase 230 V	P <sub>e</sub>	kW	7.4		11.6	
three-phase 230 V			12.7		20.1	
three-phase 400 V			22.2		34.9	
Maximum operating frequency for AC-22		op. c./h	300			
Electrical endurance for AC-22		op. c.	50.000			
Rated operational current for AC-23	I <sub>e</sub>	A	22		30	
Operational power for AC-3, AC-7b and AC-23:						
single-phase 230 V	P <sub>e</sub>	kW	3.7		5	
three-phase 230 V			5.5		8.5	
three-phase 400 V			11		15	
Maximum operating frequency for AC-3, AC-7b and AC-23		op. c./h	600			
Electrical endurance for AC-3, AC-7b and AC-23		op. c.	150.000			

<sup>1)</sup> Surrounding air temperature for 4NO contacts version -13 °F...104 °F / -25 °C ... 40 °C, for others contacts version 5 °F ... 104 °F / -15 °C ... +40 °C

<sup>2)</sup> Surrounding air temperature for 4NO contacts version -13 °F...95 °F / -25 °C ... 35 °C, for others contacts version 5 °F ... 95 °F / -15 °C ... +35 °C

<sup>3)</sup> Rated voltage 480 V valid only for UL and CSA



## TECHNICAL DATA

Type	Symbol	Unit	IKA440	IKD440	IKA463	IKD463
Rated motor power acc. to standards UL and CSA:						
single-phase 120 V	P <sub>e</sub>	HP	1	1	2	2
single-phase 208 V			2	2	3	3
single-phase 240 V			3	3	5	5
three-phase 120 V			3	3	5	5
three-phase 208 V			7 1/2	7 1/2	10	10
three-phase 240 V			7 1/2	7 1/2	10	10
three-phase 460 V			15	15	20	20
Maximum operating frequency for motors acc. to UL and CSA		op. c./h	360			
Electrical endurance for motors according to UL and CSA		op. c.	150.000			
General use according to standards UL and CSA:						
single-phase 240 V	I <sub>e</sub>	A				
three-phase 480 V			40	40	63	63
Maximum operating frequency for general use acc. to UL and CSA		op. c./h	360			
Electrical endurance for general use acc. to UL and CSA		op. c.	100.000			
Switching of discharge lamps acc. to standards UL and CSA:						
single-phase 240 V - standard ballast	I <sub>e</sub>	A				
three-phase 480 V - standard ballast			30	30	40	40
Maximum operating frequency for discharge lamps acc. to UL and CSA		op. c./h	360			
Electrical endurance for discharge lamps acc. to UL and CSA		op. c.	100.000			
Rated operational current for AC-5a (at 230 V)	I <sub>e</sub>	A	20		32	
Maximum operating frequency for AC-5a		op. c./h	600			
Electrical endurance for AC-5a		op. c.	100.000			
Rated operational current for AC-5b (at 230 V)	I <sub>e</sub>	A	17.6		22	
Maximum operating frequency for AC-5b		op. c./h	600			
Electrical endurance for AC-5b		op. c.	100.000			
Rated operational current for AC-6a (at 230 V)	I <sub>e</sub>	A	10.8		17.2	
Maximum operating frequency for AC-6a		op. c./h	600			
Electrical endurance for AC-6a		op. c.	100.000			
Switching of capacitors AC-6b and AC-7c (at 230 V)	C	µF	220		330	
Maximum operating frequency for AC-6b and AC-7c		op. c./h	600			
Electrical endurance for AC-6b and AC-7c		op. c.	100.000			
Rated operational current for DC-1 (L/R ≤ 1 ms):						
1 pole ... 24 V DC/48 V DC/60 V DC/110 V DC/ 220 V DC	I <sub>e</sub>	A	40/25/18/4/1.2		63/26/20/4/1.2	
2 poles in series ... 24 V DC/48 V DC/60 V DC/110 V DC/ 220 V DC			40/38/32/10/8		63/42/34/10/8	
3 poles in series ... 24 V DC/48 V DC/60 V DC/110 V DC/ 220 V DC			40/40/40/30/20		63/63/60/35/30	
4 poles in series ... 24 V DC/48 V DC/60 V DC/110 V DC/ 220 V DC			40/40/40/40/40		63/63/63/63/63	
Maximum operating frequency for DC-1		op. c./h	300			
Electrical endurance for DC-1		op. c.	100.000			
Rated operational current for DC-3 (L/R ≤ 2 ms):						
1 pole ... 24 V DC/48 V DC/60 V DC/110 V DC/ 220 V DC	I <sub>e</sub>	A	22/10/5/1.5/0.3		25/11/5/1.5/0.3	
2 poles in series ... 24 V DC/48 V DC/60 V DC/110 V DC/ 220 V DC			40/20/16/5/1		45/22/18/5/1	
3 poles in series ... 24 V DC/48 V DC/60 V DC/110 V DC/ 220 V DC			40/40/32/15/4		63/45/35/18/5	
4 poles in series ... 24 V DC/48 V DC/60 V DC/110 V DC/ 220 V DC			40/40/40/40/10		63/63/63/63/10	
Maximum operating frequency for DC-3		op. c./h	300			
Electrical endurance for DC-3		op. c.	100.000			
Rated operational current for DC-5 (L/R ≤ 7.5 ms):						
1 pole ... 24 V DC/48 V DC/60 V DC/110 V DC/ 220 V DC	I <sub>e</sub>	A	20/8/4/1/0.2		25/10/5/1/0.2	
2 poles in series ... 24 V DC/48 V DC/60 V DC/110 V DC/ 220 V DC			40/18/14/5/0.8		45/20/15/5/0.8	
3 poles in series ... 24 V DC/48 V DC/60 V DC/110 V DC/ 220 V DC			40/40/28/12/3		63/44/30/15/4	
4 poles in series ... 24 V DC/48 V DC/60 V DC/110 V DC/ 220 V DC			40/40/40/35/8		63/63/60/45/10	
Maximum operating frequency for DC-5		op. c./h	300			
Electrical endurance for DC-5		op. c.	100.000			
Terminal capacity:						
rigid (solid and stranded)	S		14 ... 10 AWG / 1.5 ... 25 mm <sup>2</sup>			
flexible			14 ... 4 AWG / 1.5 ... 16 mm <sup>2</sup>			
Length of removed wire insulation			0.394 in / 10 mm			
Screw			M5			
Screw head			PZ2			
Tightening torque			30.98 lb-in / 3.5 Nm			
Contact reliability			≥17 V; ≥50 mA			
Minimum distance of open contacts			0.118 in / 3.6 mm			
Power dissipation per pole		W	4		8	
Overload current withstand capability: 10 s			176		240	
Maximum back-up fuse for short-circuit protection gL and gG: coordination type 1	I <sub>v</sub>	A	63		80	
coordination type 2			40		63	

# Installation Contactors UL/CSA

## up to 63 A



### TECHNICAL DATA

Type	Symbol	Unit	IKA440	IKD440	IKA463	IKD463
Maximum back-up fuse for short-circuit protection K5 acc. to UL and CSA	$I_v$	A	60	60	70	70
Rated insulation voltage	$U_i$	V	440			
Rated impulse withstand voltage	$U_{imp}$	kV	4			
Rated operational voltage	$U_e$	V	230/400			
Rated frequency	f	Hz	50/60			
Thermal current	$I_{th}$	A	40		63	
Rated operational current for AC-15: single-phase 230 V single-phase 400 V	$I_e$	A	6 4			
Maximum operating frequency for AC-15		op. c./h	1.200			
Electrical endurance for AC-15		op. c.	150.000			
Switching of auxiliary loads according to standard UL and CSA			B300, P300			
Maximum operating frequency for auxiliary loads according to UL and CSA		op. c./h	360			
Electrical endurance for auxiliary loads according to UL and CSA		op. c.	100.000			
Rated operational current for DC-13: 1 pole ... 24 V DC/48 V DC/60 V DC/110 V DC/ 220 V DC 2 poles in series ... 24 V DC/48 V DC/60 V DC/110 V DC/ 220 V DC 3 poles in series ... 24 V DC/48 V DC/60 V DC/110 V DC/ 220 V DC 4 poles in series ... 24 V DC/48 V DC/60 V DC/110 V DC/ 220 V DC	$I_e$	A	6/4/1/0.3/0.05 6/6/4/1/0.1 6/6/6/3/1 6/6/6/4/2			
Maximum operating frequency for DC-13		op. c./h	300			
Electrical endurance for DC-13		op. c.	200.000			
Terminal capacity: rigid (solid and stranded) flexible	S		4 ... 10 AWG / 1.5... 25 mm <sup>2</sup> 4 ... 10 AWG / 1.5... 16 mm <sup>2</sup>			
Length of removed wire insulation			0.394 in / 10 mm			
Screw			M5			
Screw head			PZ2			
Tightening torque			30.98 lb-in / 3.5 Nm			
Range of control voltage for switch-on	$U_c$	%	85 ... 110			
Range of control voltage for drop out	$U_c$	%	AC: 75 ... 20 / DC: 75 ... 10 (where is applicable)			
Kind of voltage			AC	AC/DC	AC	AC/DC
Standard control voltages	$U_c$	V	12, 24, 48, 110, 120, 127, 208, 230, 240			
Frequency of AC control voltage	f	Hz	50/60			
Control mode			remote control with $U_c$			
Impulse duration of control voltage: minimum maximum			permanent permanent			
Minimum duration between two impulses of control voltage		ms	AC: 150 / DC: 500 (where is applicable)			
Surge immunity withstand voltage 1,2/50 $\mu$ s acc. to standard IEC/EN 61000-4-5		kV	2			
Coil consumption: switch-on operation		VA/W	15.4/6 7.7/3	5/5 <sup>1)</sup> 5/5 <sup>1)</sup>	15.4/6 7.7/3	5/5 <sup>1)</sup> 5/5 <sup>1)</sup>
Delays: make brake		ms	10 ... 20 10 ... 15	15 ... 20 35 ... 45	10 ... 20 10 ... 15	15 ... 20 35 ... 45
Terminal capacity: rigid (solid and stranded) flexible			16 ... 14 AWG / 1 ... 2.5 mm <sup>2</sup> 16 ... 14 AWG / 1 ... 2.5 mm <sup>2</sup>			
Length of removed wire insulation			0.315 in / 8 mm			
Screw			M3			
Screw head			PZ1			
Tightening torque			5.31 lb-in / 0.6 Nm			
MTTF - Mean time to failure MTTF = $1/\lambda = B10/(0.1 n_{op})$		h	General Use: 2.083 Motor: 3.125			
MTTF <sub>d</sub> - Mean time to failure dangerous MTTF <sub>d</sub> = $1/\lambda_d = B10_d/(0.1 n_{op})$		h	General Use: 2.777 Motor: 4.166			
B10 - Number of operating cycles until 10 % of devices fail		op. c.	General Use: 75.000 Motor: 112.500			
B10 <sub>d</sub> - Number of operating cycles until 10 % of device dangerous		op. c.	General Use: 100.000 Motor: 150.000			
B10 <sub>d</sub> = B10/ratio of dangerous failures						
$\lambda$ - Failure rate $\lambda = (0.1 n_{op})/B10$		1/h	General Use: 0.00048 Motor: 0.00032			
$\lambda_d$ - Failure rate dangerous $\lambda_d = (0.1 n_{op})/B10_d$		1/h	General Use: 0.00036 Motor: 0.00024			
Ratio of dangerous failures		%	75			
$n_{op}$ - Operating cycles (operating cycles/h)		op. c./h	360			

<sup>1)</sup> Coil consumption for -22 and -04 is 6.1 VA/6.1 W

### IKN, IKN-UL – Auxiliary switch

#### TECHNICAL DATA

Type	Symbol	Unit	IKN	IKN-UL
Standards			IEC/EN 60947-5-1	UL508, C22.2 No. 14, IEC/EN 60947-5-1
Approvals			CE, CB, NF, EAC	CE, UL, CSA
Module width			0.5	0.5
Number of poles			2	2
Degree of protection			IP20 <sup>1)</sup>	IP20 <sup>1)</sup>
Pollution degree			3	3
Climatic conditions			95 % relative humidity	
Ambient temperature:				
open			-25 °C ... +55 °C	
closed				-13 °F ... 104 °F / -25 °C ... +40 °C
Storage temperature			-30 °C ... +80 °C	-22 °F ... 176 °F / -30 °C ... +80 °C
Maximum altitude		m	2000	2000
U <sub>i</sub> and U <sub>e</sub> is reduced for 1.2% and I <sub>e</sub> for 0.4% for every additional 100 m				
Mechanical endurance		op. c.	3.000.000	3.000.000
Weight			30 g	0.08 lb / 30 g
Contact reliability			≥12 V; ≥5 mA	≥12 V; ≥5 mA
Minimum distance of open contacts			3.6 mm	0.142 in / 3.6 mm
Power dissipation per pole		W	0.3	0.3 (at I <sub>th</sub> = 6 A)
Maximum back-up fuse for short-circuit protection gL and gG: coordination type 2	I <sub>v</sub>	A	6	6
Maximum back-up fuse for short-circuit protection KS acc. to UL and CSA	I <sub>v</sub>	A		6
Rated insulation voltage	U <sub>i</sub>	V	500	500
Rated impulse withstand voltage	U <sub>imp</sub>	kV	4	4
Rated operational voltage	U <sub>e</sub>	V	230/400	IEC: 230 / 400 UL: C300 (120 VAC, 240 VAC) UL: Q300 (125 VDC, 250 VDC)
Rated frequency	f	Hz	50/60	50/60
Thermal current	I <sub>th</sub>	A	6	IEC: 6; UL: 2.5
Rated operational current for AC-15:				
single-phase 230 V	I <sub>e</sub>	A	6	6
single-phase 400 V			4	4
Electrical endurance for AC-15		op. c.	50.000	50.000
Switching of auxiliary loads acc. to standard UL and CSA				C300, Q300
Electrical endurance for auxiliary loads acc. UL and CSA		op. c.		50.000
Rated operational current for DC-13:				
1 pole ... 24 VDC / 48 VDC / 60 VDC / 110 VDC / 220 VDC	I <sub>e</sub>	A	6/4/1/0.3/0.05	6/4/1/0.3/0.05
2 poles in series ... 24 VDC / 48 VDC / 60 VDC / 110 VDC / 220 VDC			6/6/4/1/0.1	6/6/4/1/0.1
Electrical endurance for DC-13		op. c.	50.000	50.000
Switching of auxiliary loads acc. to standard UL and CSA				C300, Q300
Electrical endurance for auxiliary loads acc. UL and CSA		op. c.		50.000
Terminal capacity:				
rigid (solid and stranded)	S		1 ... 2.5 mm <sup>2</sup>	16 ... 14 AWG / 1 ... 2.5 mm <sup>2</sup>
flexible			1 ... 2.5 mm <sup>2</sup>	16 ... 14 AWG / 1 ... 2.5 mm <sup>2</sup>
Length of removed wire insulation			7 mm	0.276 in / 7 mm
Screw			M3	M3
Screw head			PZ1	PZ1
Tightening torque			0.8 Nm	7.08 lb-in / 0.8 Nm
MTTF - Mean time to failure		h	833	694
MTTF = 1/λ = B10/(0.1 n <sub>op</sub> )				
MTTF <sub>d</sub> - Mean time to failure dangerous		h	1.666	1.388
MTTF <sub>d</sub> = 1/λ <sub>d</sub> = B10 <sub>d</sub> /(0.1 n <sub>op</sub> )				
B10 - Number of operating cycles until 10 % of devices fail		op. c.	25.000	25.000
B10 <sub>d</sub> - Number of operating cycles until 10 % of device dangerous		op. c.	50.000	50.000
B10 <sub>d</sub> = B10/ratio of dangerous failures				
λ - Failure rate		1/h	0.0012	0.00144
λ = (0.1 n <sub>op</sub> )/B10				
λ <sub>d</sub> - Failure rate dangerous		1/h	0.0006	0.00072
λ <sub>d</sub> = (0.1 n <sub>op</sub> )/B10 <sub>d</sub>				
Ratio of dangerous failures		%	50	50
n <sub>op</sub> - Operating cycles (operating cycles/h)		op. c./h	300	360

<sup>1)</sup> IP40 when installed in installation box - distribution boards

# Installation Switches IKS-R

## Installation Momentary Switches IKS-T



### TECHNICAL DATA

	Type	Symbol	Unit	IKS220-R	IKS225-R	IKS232-R	IKS420-R	IKS425-R	IKS432-R
				IKS220-T	IKS225-T	IKS232-T	IKS42-T	IKS425-T	IKS432-T
GENERAL	Standards			IEC/EN 60947-3					
	Approvals			CE					
	Module width			2			4		
	Number of poles			2			4		
	Degree of protection			IP20 (IP40 when installed in installation box - distribution board)					
	Pollution degree			3					
	Climatic conditions			95 % relative humidity					
	Ambient temperature (open)		°C	-25 ... +55					
	Storage temperature		°C	-30... +80					
	Maximum altitude <i>U<sub>i</sub></i> and <i>U<sub>e</sub></i> is reduced for 1.2 % and <i>I<sub>e</sub></i> for 0.4 % for every additional 100 m		m	2000					
	Number of contactors or switches side-by-side: <40 °C (40 ... 55) °C			no limitation					
	Maximum operating frequency with no load		op. c./h	600					
	Mechanical endurance		op. c.	1.000.000					
	Weight		g	55			105		
	MAIN CIRCUIT	Contact reliability			≥17 V; ≥50 mA				
Minimum distance of open contacts			mm	3,6					
Power dissipation per pole			W	1.7	2	2.5	1.7	2	2.5
Overload current withstand capability: 10 s				72			68		
Maximum back-up fuse for short-circuit protection gL and gG: coordination type 1		<i>I<sub>v</sub></i>	A	20	25	32	20	25	32
Rated insulation voltage		<i>U<sub>i</sub></i>	V	440					
Rated impulse withstand voltage		<i>U<sub>imp</sub></i>	kV	4					
Rated operational voltage		<i>U<sub>e</sub></i>	V	230					
Rated frequency		<i>f</i>	Hz	50/60					
Thermal current		<i>I<sub>th</sub></i>	A	20	25	32	20	25	32
Rated operational current for AC-1, AC-7a and AC-21		<i>I<sub>e</sub></i>	A	20	25	32	20	25	32
Operational power for AC-1, AC-7a and AC-21: single-phase 230 V three-phase 230 V		<i>P<sub>e</sub></i>	kW	4	5.4	7	4	5.4	7
Maximum operating frequency for AC-1, AC-7a and AC-21			op. c./h	300					
Electrical endurance for AC-1, AC-7a and AC-21			op. c.	100.000					
Rated operational current for AC-22		<i>I<sub>e</sub></i>	A	20	25	32	20	25	32
Operational power for AC-22: single-phase 230 V three-phase 230 V		<i>P<sub>e</sub></i>	kW	3.7	4.6	5.9	3.7	4.6	5.9
Maximum operating frequency for AC-1, AC-7a and AC-21			op. c./h	300					
Electrical endurance for AC-1, AC-7a and AC-21			op. c.	50.000					
Rated operational current for AC-5a (at 230 V)		<i>I<sub>e</sub></i>	A	8.8	11	13	8.8	11	13
Maximum operating frequency for AC-5a			op. c./h	300					
Electrical endurance for AC-5a (at 230 V)			op. c.	100.000					
Rated operational current for AC-5b (at 230 V)		<i>I<sub>e</sub></i>	A	8.8	9.7	11	8.8	9.7	11
Maximum operating frequency for AC-5b			op. c./h	300					
Electrical endurance for AC-5b (at 230 V)			op. c.	100.000					
Rated operational current for AC-6a (at 230 V)		<i>I<sub>e</sub></i>	A	4	4.8	6	4	4.8	6
Maximum operating frequency for AC-6a			op. c./h	300					
Electrical endurance for AC-6a (at 230 V)			op. c.	100.000					
Switching of capacitors AC-6b and AC-7c (at 230 V)		<i>C</i>	µF	30	36	40	30	36	40
Maximum operating frequency for AC-6b and AC-7c			op. c./h	300					
Electrical endurance for AC-6b and AC-7c			op. c.	100.000					
Terminal capacity: rigid (solid and stranded) flexible		<i>S</i>	mm <sup>2</sup>	1 ... 10 1 ... 6					
Length of removed wire insulation			mm	9					
Screw				M3.5					
Screw head			PZ1						
Tightening torque		Nm	1.2						

Diagram 1

AC-1/230V/1-phase for IKA20, IKD20, IKA220 (UL), IKD220 (UL), IKA225, IKD225, IKA232, IKD232, IKA440 (UL), IKD440 (UL), IKA463 (UL), IKD463 (UL)  
 AC-1/400V/3-phase for IK21, IKA25, IKD25, IKA425 (UL), IKD425 (UL), IKA432, IKD432, IKA40, IK40, IKA63, IK63

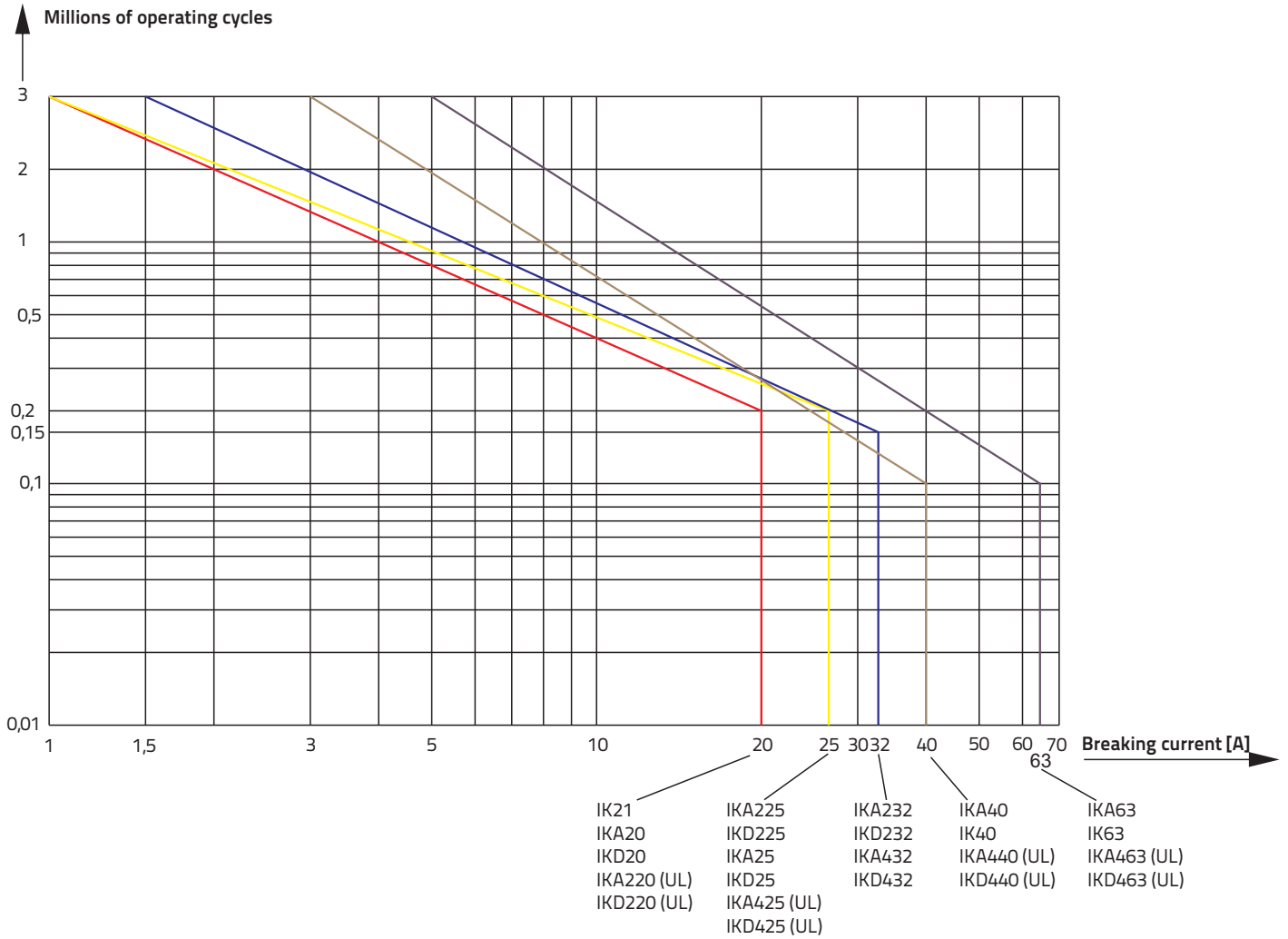

# Installation Contactors

## Electrical Endurance

Diagram 2

AC-3/400V/3-phase for IK21, IKA25, IKD25, IKA425 (UL), IKD425 (UL), IKA432, IKD432, IKA40, IKA63, Ik63, IKA440 (UL), IKD440 (UL), IKA463 (UL), IKD463 (UL)

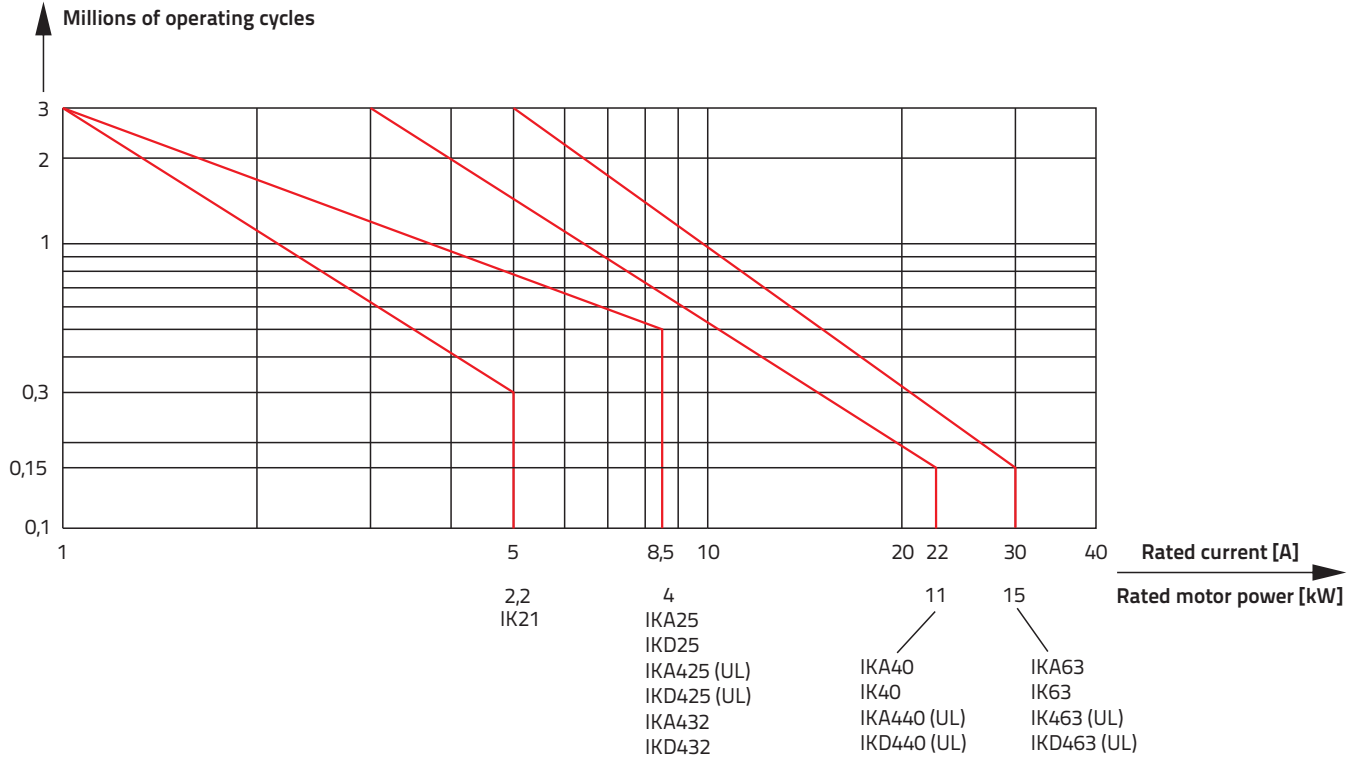
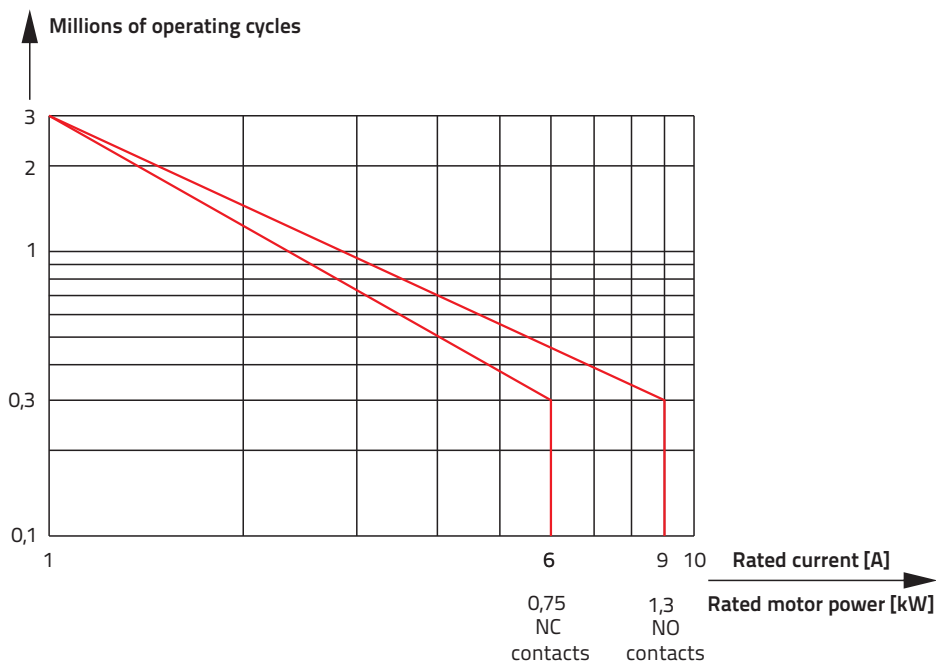
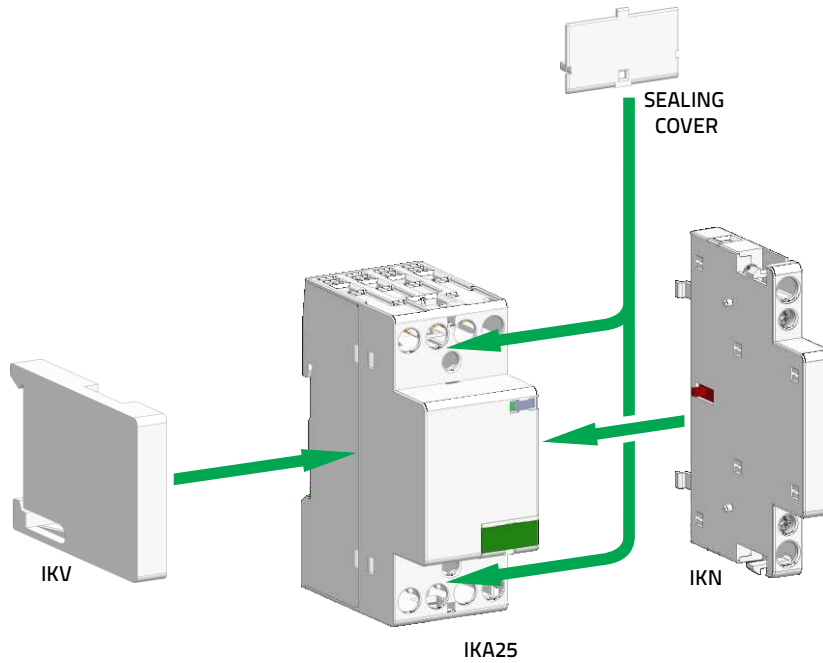

Diagram 3

AC-3/230V/1-phase for IKA20, IKD20, IKA220 (UL), IKD220 (UL), IKA225, IKD225, IKA232, IKD232



Mounting positions of accessories



# Installation Contactors

## Operating Position, Dimensions

### Operation position

IKA20/225/232/ 25/432/ 40/ 63  
IKA220/425/ 440/ 463 (UL)

180°

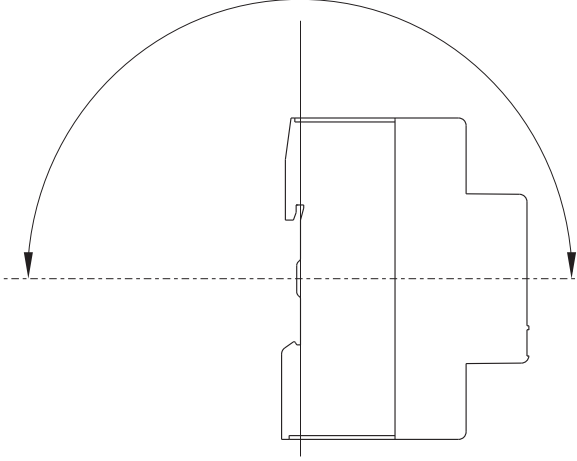

All installation contactors

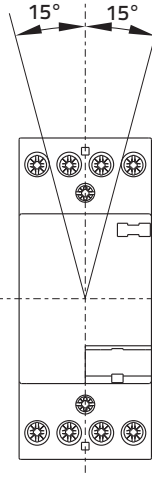

IKD20/225/232/ 25/432  
IK40/63, IKD220/425/440/463 (UL)

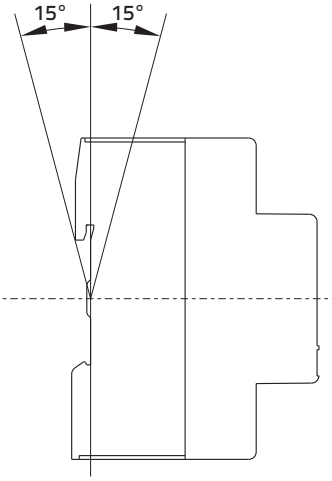

IKA20/225/232-R/-T  
IKA25/432-R/-T

180°

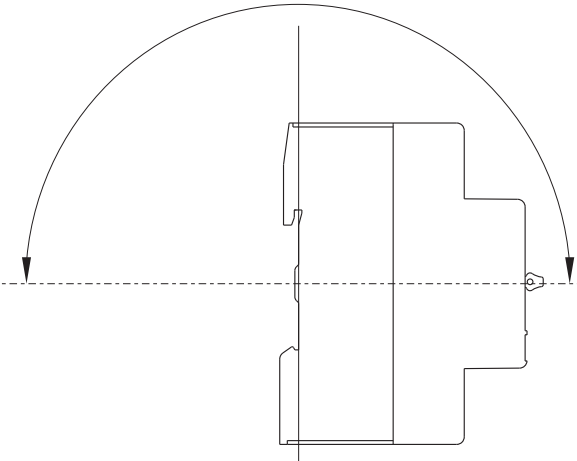

IKA/D20/225/232-R/-T  
IKA/D25/432-R/-T

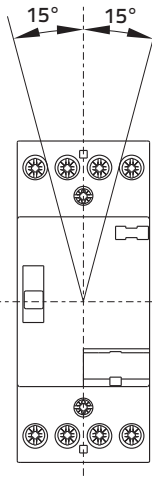

IKD20/225/232-R/-T  
IKD25/432-R/-T

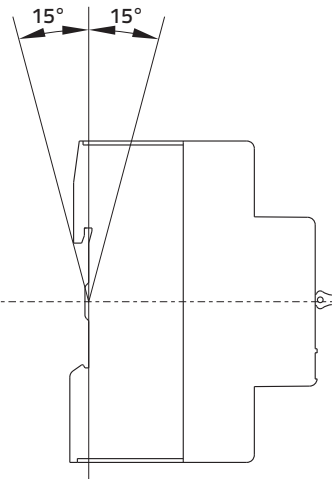

NOTE: IK21 and IKS-R/-T have no limitation

### Dimension (in millimeters)

IK21

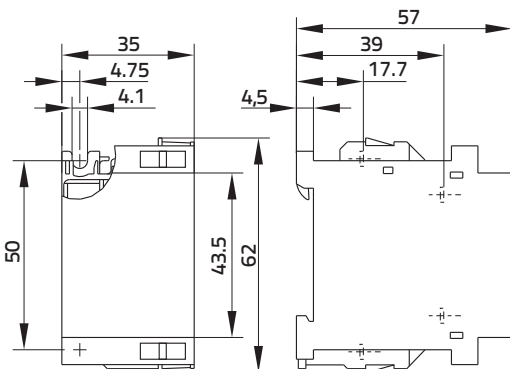

IKA20, IKD20  
IKA225, IKD225  
IKA232, IKD232

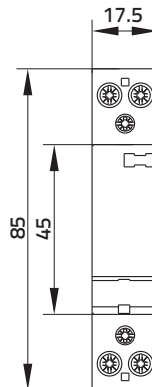

IKA25, IKD25  
IKA432, IKD432

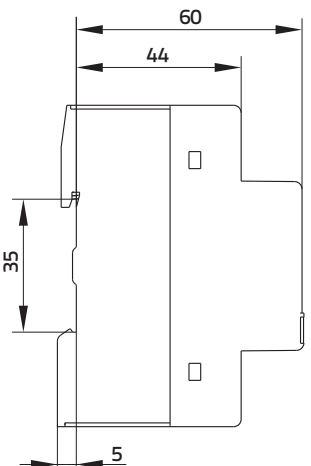
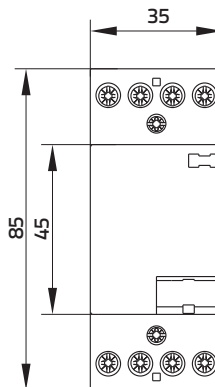



Dimensions (in millimeters unless otherwise stated)

IK40, IK63  
IKA40, IKA63

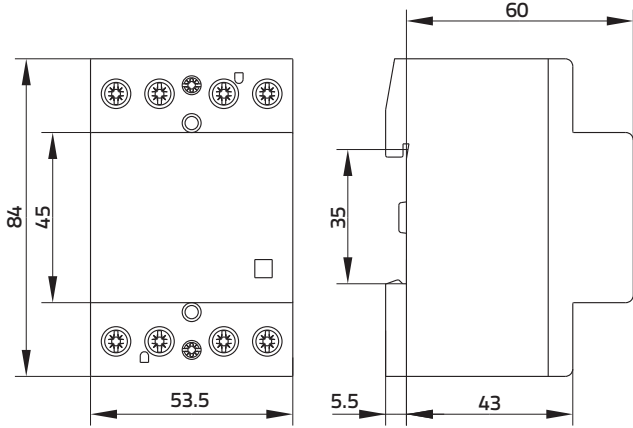

IKA20-R, IKD20-R  
IKA225-R, IKD225-R  
IKA232-R, IKD232-R

IKA25-R, IKD25-R  
IKA432-R, IKD432-R  
IKS420-R, IKS425-R, IKS432-R  
IKS420-T, IKS425-T, IKS432-T

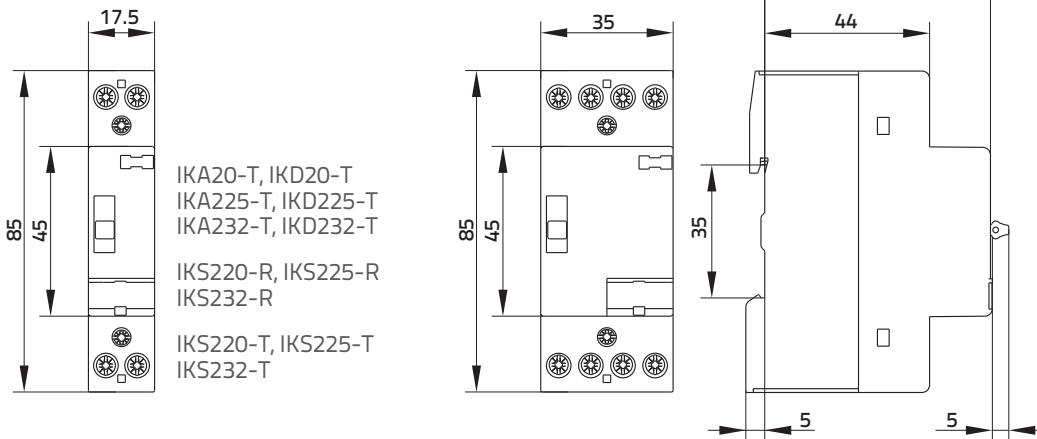

IKA220 (UL) IKA425 (UL)  
IKD220 (UL) IKD425 (UL)

IKA440 (UL), IKD440 (UL)  
IKA463 (UL), IKD463 (UL)

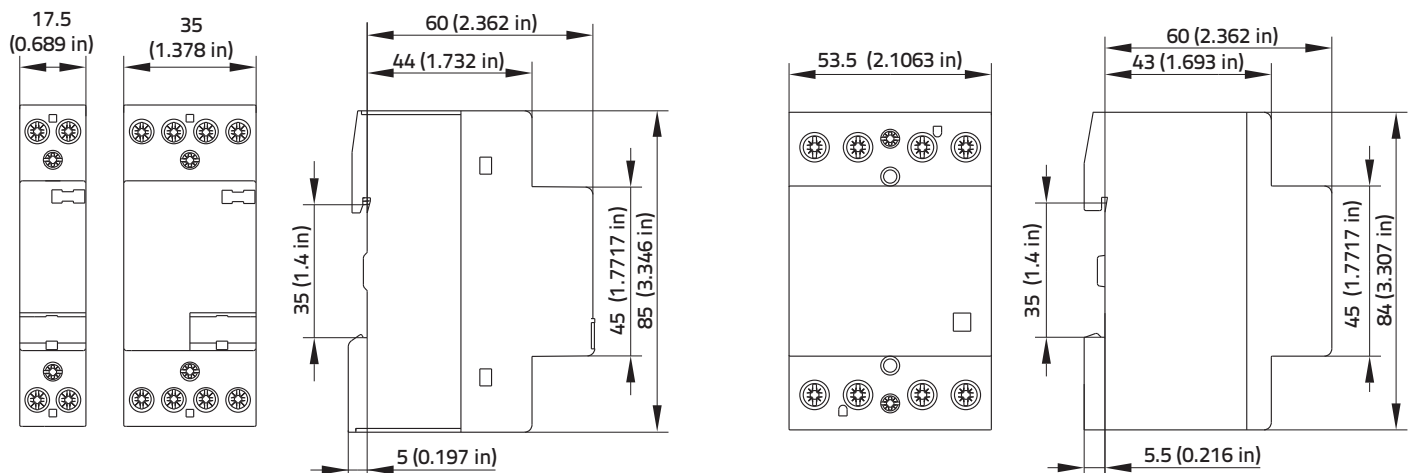

# Installation Contactors

## Dimensions

Dimensions (in millimeters unless otherwise stated)

IKN

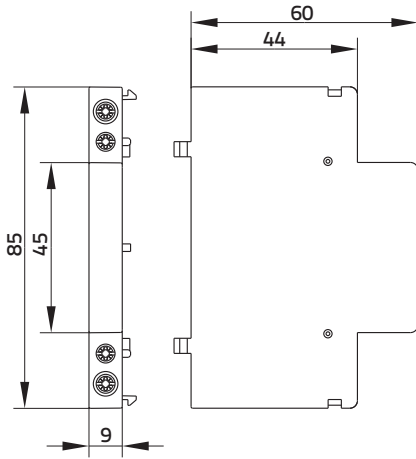

IKN-UL

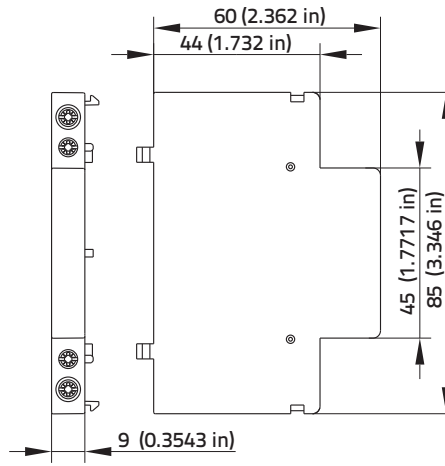

IKV

