



HESTORE.HU

elektronikai alkatrész áruház

EN: This Datasheet is presented by the manufacturer.

Please visit our website for pricing and availability at www.hestore.hu.

Potentiometers Rotary Potentiometer (Insulated shaft type)
9mm Size Insulated Shaft Snap-in Type RK09K/RK09D Series

Part number

RK09K1130AST

Standard ?



Number of resistor elements	Single-unit (20V DC)	
Control part orientation (Mounting height)	Vertical	
Collar (Sleeve type)	Without	
Shaft types	Driver	
Length of the shaft LM1	20.0mm	
Detent	Without	
Total resistance	10k Ω	
Resistance taper	1B	
Dimensions	9mm size	
Operating temperature range	-10°C to +70°C	
Electrical performance	Total resistance tolerance	$\pm 20\%$
	Rated power	0.05W
	Maximum operating voltage	50V AC, 20V DC
	Insulation resistance	100M Ω min. 250V DC
	Voltage proof	250V AC for 1 minute
Mechanical performance	Total rotational angle	280° $\pm 5^\circ$
	Rotational torque	1 to 8mN·m
	Stopper strength	0.3N·m
	Stopper strength	50N max.
	Vibration	10 to 55 to 10Hz/min., the amplitude is 1.5mm for all the frequencies, in the 3 direction of X, Y and Z and for 2 hours respectively
Durability	Operating life	5,000 cycles
Minimum order unit(pcs.)	Japan	1,000
	Export	2,000

Dimensions

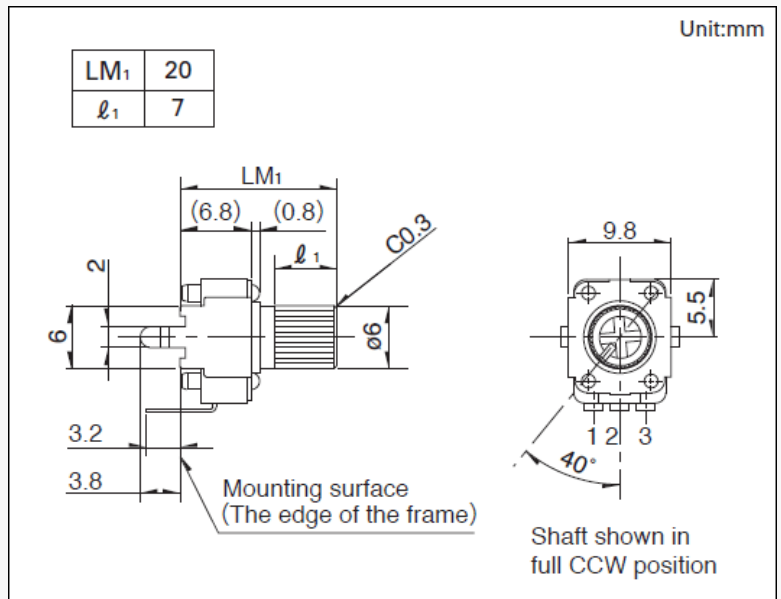

Mounting Hole Dimensions

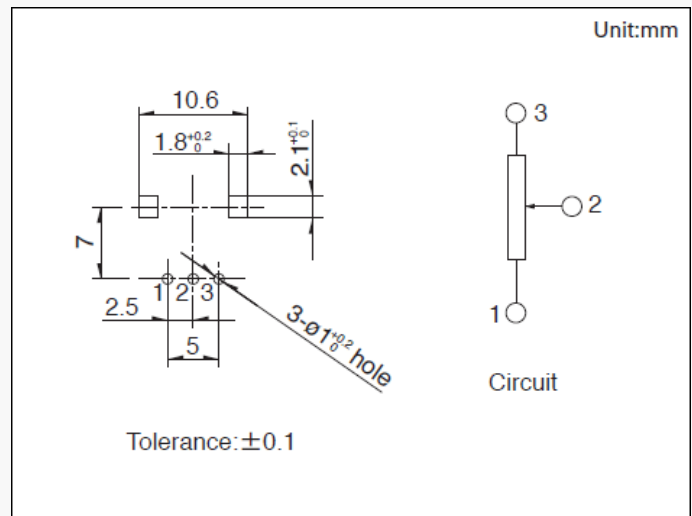

Viewed from mounting side.

Terminal Layout / Circuit Diagram

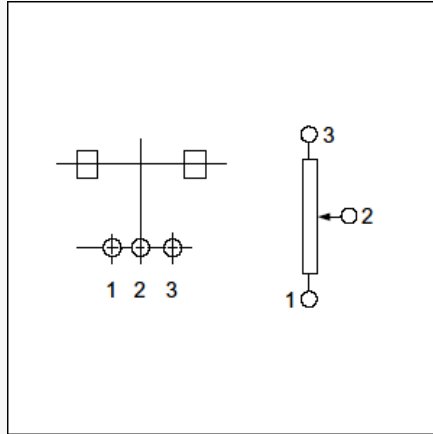

Packing Specifications

Bulk

Number of packages (pcs.)

1 case / Japan	1,000
1 case / export packing	2,000

Export package measurements (mm)

528 × 369 × 178

Soldering Conditions

Reference for Hand Soldering

Tip temperature

350°C max.

Soldering time

3s max.

No. of solders

1 time

Notes are common to this series/models

1. This site catalog shows only outline specifications. When using the products, please obtain formal specifications for supply.
2. Please place purchase orders per minimum order unit (integer).
3. Products other than those listed in above products are also available. Please contact us for details.



Cautions

Recommended Circuit Configuration

When using variable resistors, it is recommended that you use them as voltage adjusting means, as shown in Fig. A. If the variable resistor is used as a current adjusting means as in Fig. B, it may be influenced by the contact resistance between the resistor body and the slide, depending on the set circuit. Conducting a test under actual operating conditions is highly recommended.

A. Voltage divider type

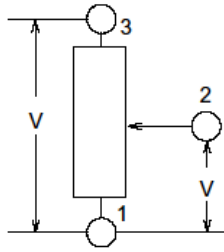

B. Current controller type

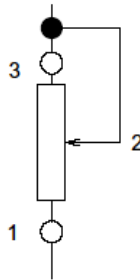

Terminal Connections

In applications where a direct current is allowed to flow through the potentiometer's sliding arm, there could be a problem of anodic oxidation due to an unusual increase in resistance value. In this case, it is recommended that you connect the negative line to the resistance element and the positive line to the sliding arm.

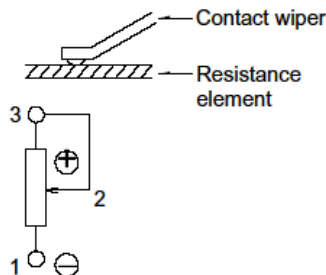

Direct Voltage

When direct voltage is flown through this part, terminal to terminal insulation may deteriorate depending on the use environment. This is due to a migration phenomenon. Contact us if you are planning to use this part under direct voltage.

Impedance on the Output Side

There is a possibility that might be affected by contact resistance of resistive element and wiper in case of low impedance of output side in voltage regulation circuit. For this reason, we require that you adjust to impedance of output side more than 100 times of total resistance.

Residual Resistance

Although electric poles of resistors are generally formed by silver printing, we provide carbon coating over the silver poles to enhance reliability against sulfurization. Contact us if you wish to use the part in a low residual resistance state.

Dew Condensation

Avoid using the potentiometer where dew or water drops might occur on the surface of the resistor, etc. Deterioration of insulation or shorting may occur.

Soldering

Avoid employing wiring designs and soldering methods in which molten solder flows over the upper surface of PC board, as illustrated in the schematic drawing. This can cause occurrences of imperfect contacts.

Solder all metal inserted fixing including terminals & metal lugs into a substrate.

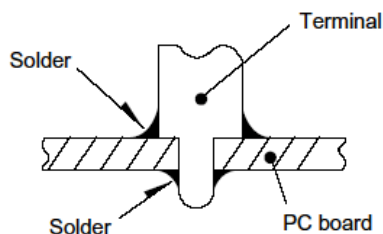

Stress Being Applied to the Terminals

Always pay special attention not to apply excessive stress when handling the terminals. Also, be sure to design appropriate soldering conditions.

Looseness of the Shaft

When lengthy shaft lengths are being employed, the looseness (deviation) tends to grow in proportion to the shaft length. Conducting a test under actual operating conditions is recommended.

Chassis Mounting

The use of a nut to fasten this part may lead to excessive tightening and can deteriorate the rotary contact performance, or strip the threads. Handle with care when tightening the nut.

Use of Chemicals

Since synthetic resins such as polycarbonate are being used as the material for the insulated type shafts, avoid using this part under gassy environments of such chemicals as ammonia, amines, alkali water solutions, aromatic hydrocarbons, ketones, esters and halogenated hydrocarbons, especially, under their intensive gas environments.

Operation at Low Temperature

When these products are expected to be used under low temperature environments such as applications for car radios and car stereos, we can customize them for easier and more smooth rotary movements. When placing orders, indicate whether the low temperature specification is necessary or not.

Storage

1. Store the products as delivered, at a normal temperature and humidity, without direct sunshine and corrosive gas ambient. Use them at an earliest possible timing, not later than six months upon receipt.
2. After breaking the seal, keep the products in a plastic bag to shut out ambient air, store them in the same environment as above, and use them up as soon as possible.
3. Do not stack too many switches.

Slide Potentiometers

Lever Length

Design the height from the surface of the board up to the top of the knob as short as possible. The longer mounting height will result in worsening of the sliding feel. Verify the performance under actual operational conditions.

Driving Lever

Avoid using the lever in such a way that the point of application is far away from the center of the lever. The longer the length indicated by "B" becomes, the worse a sliding feel gets. Verify the performance under actual operational conditions.

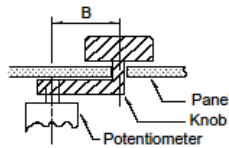

Chassis Mounting

The use of a nut to fasten this part may lead to excessive tightening and can deteriorate the rotary contact performance, or strip the threads. Handle with care when tightening the nut.

Motor-Driven Potentiometers

Precautions in Using the Motor-driven Potentiometer

1. Avoid using the potentiometer in silicon or cyanogens-base gas atmosphere. Otherwise, the motor may not operate properly. When using additives, grease and silicon rubber in the same set, pay attention to their composition.
2. Avoid connecting the fixed resistance in series with the motor in the motor circuit. When starting up the motor, there may be cases where driving voltage drops, causing a starting failure.
3. Avoid using the potentiometer below specified voltage. For reducing the rotational speed, consult us.

The above operation notes are quoted from the "Precaution and Guideline of Potentiometer for Electrical Devices", which is a technical report issued by the Japan Electronics and Information Technology Industries Association RCR-2191A (in March 2002).

For details, see the above technical report.

Measurement and Test Methods

Electrical performance

Total Resistance

With the shaft (lever) placed at the termination of terminal 1 or 3, total resistance shall be determined by measuring the resistance between the resistor terminals 1 and 3 unless otherwise specified.

Rated Power

Rated power shall be the maximum value of electric power that can be applied continuously to the whole area of a resistor (between terminals 1 and 3) at the rated ambient temperature.

The rated ambient temperature of a carbon film resistor shall be 50° C. The maximum power at an ambient temperature of 50 to 70° C shall be obtained by multiplying the rated power by the rated power ratio determined from the derating curve shown below.

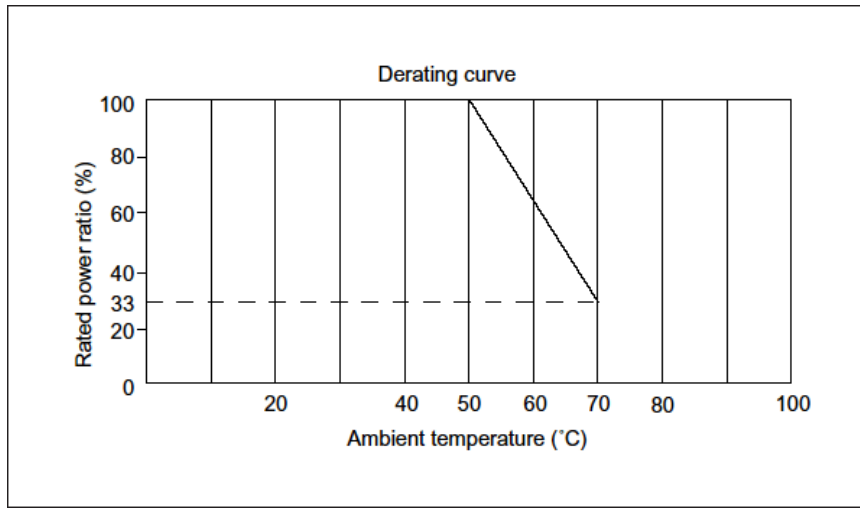

Rated Voltage

Rated voltage is associated with the rated power and shall be determined by the following equation. When the resulting rated voltage exceeds the maximum operating voltage of a specific resistor, the maximum operating voltage shall be taken as the rated voltage.

$E = \sqrt{P \cdot R}$
E : rated voltage (V)
P : rated power (W)
R : total nominal resistance (Ω)

Tap Resistance

Determined by measuring the resistance between a tap terminal and a specified terminal (terminal 1 or terminal 3).

Residual Resistance

With the shaft (lever) placed at the termination of terminal 1, the resistance shall be measured between the terminals 1 and 2. Next, with the shaft (lever) placed at the end of terminal 3, the resistance shall be measured between the terminals 2 and 3. If there are tap terminals, the shaft (lever) shall be turned (moved) and the resulting minimum resistance between the tap terminal and the terminal 2 shall be measured.

Maximum Attenuation Level

With the shaft placed at the termination of terminal 1, maximum attenuation level shall be determined by measuring the voltage applied between the terminals 1 and 2, and calculating the ratio to the voltage applied between the terminals 1 and 3. Unless otherwise specified, the value obtained shall be used in place of the residual resistance of a rotary potentiometer for volume control.

Insertion Loss

With the shaft placed at the termination of terminal 3, insertion loss shall be determined by measuring the voltage applied between the terminals 1 and 2 and calculating the ratio to the voltage applied between the terminals 1 and 3. Unless otherwise specified, the value obtained shall be used in place of the residual resistance of a rotary potentiometer for volume control.

Sliding Noise

Measured by connecting the resistor to an amplifier having frequency characteristics specified in JIS C 6443, applying DC voltage of 20V between the terminals 1 and 3 (if rated voltage is 20V or less, this voltage shall be applied) and by rotating (moving) the shaft (lever) at a speed of about 30 cycles per minute.

Voltage Withstand

Determined by applying AC voltage to the specified locations for one minute to checking for any arc, burning, dielectric breakdown and other abnormalities. Respective terminals may be tested together. The locations described below shall be tested unless otherwise specified. However, if the section concerned is so constructed as to conduct, that particular part shall not be tested.

Insulation Resistance

Measured with a megger by applying specified voltage to the specified locations. The locations below shall be tested unless otherwise specified. However, if the section concerned is so constructed as to conduct, that particular part shall not be tested.

Measuring Locations For Withstand Voltage and Insulation Resistance

- Between terminal and shaft (lever)
- Between terminal and metal cover (frame)
- Between terminals connected to separate resistor element and terminal connected to another resistor element (of multi-ganged-unit)
- Between switch terminal and shaft
- Between switch terminal and resistance terminal
- Between switch terminal and metal cover

Gang Error

With the shaft (lever) placed in the specified position, gang error shall be determined by applying test voltage of 2 to 15V (sine-wave RMS value) between the terminals 1 and 3 at 1,000±200Hz and measuring the voltage between the resistor terminal 2 and the specified terminal (terminal 1 or 3) and then by using the following equation. If there are no questions on determination, DC voltage may be applied for this test.

$Gang\ error = 20 \log \frac{V_2}{V_1}$

Where,

V1: Voltage between the reference resistor terminals 1 and 2 (voltage between the terminals 2 and 3 if the resistance tapers are C, E and reverse D)

V2: Voltage between the non-reference resistor terminals 1 and 2 (voltage between the terminals 2 and 3 if the resistance tapers are C, E and reverse D)

If there is a tap terminal, measurement shall be made by connecting a fixed resistor whose resistance is equivalent to 1/10 of the nominal total resistance between the tap terminal and the terminal 1 (if the resistance taper is C, make connection between

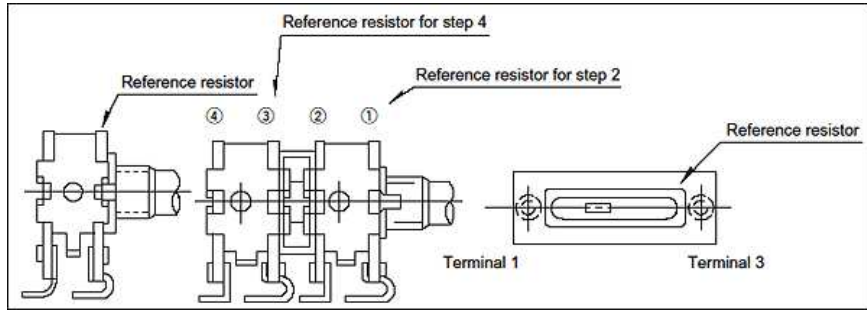

Contact Resistance of Switch

Unless otherwise specified, contact resistance of switch shall be determined by measuring drop voltage when 5V DC, 1A is applied between contacts and the contacts are closed.

Mechanical Performance

Total Rotational Angle (Travel)

Determined by measuring the rotational angle (travel) when the shaft (lever) is turned (moved) from the termination position of terminal 1 to the termination position of terminal 3.

Rotational Torque (Operating Force)

Determined by measuring the torque (operating force) necessary to turn (move) the shaft (lever). Unless otherwise specified, measurement shall be made at an ambient temperature of 5 to 35° C, and the shaft rotational speed shall be 60° per second and the lever moving speed 20mm per second.

Starting Torque (Starting Force)

Determined by measuring a torque (operating force) necessary to turn (move) the shaft (lever) for the first time after allowing the test piece to stand for a long period of time. Unless otherwise specified, measurement shall be made at an ambient temperature of 5 to 35° C, and the shaft rotational speed shall be 60° per second and the lever moving speed 20mm per second.

Remarks:

To be specified only when required in particular.

Shaft Wobble

Determined by measuring the amount of deflection at a position of 30mm from the reference surface with a bending moment of 0.1N·m (50mN·m for insulated shaft) applied perpendicularly to the shaft from 180° different directions at a point within 3mm from the place where a smooth cylindrical surface of the shaft ceases to exist. However, if the length of the shaft is less than 30mm, proportional calculation shall be used.

Allowable Operating Torque for Shaft (Lever)

With the shaft (lever) placed at the termination of terminal 1, a specified torsional moment (force) shall be applied in that direction for 10 seconds. Next, the shaft (lever) shall be placed at the termination of terminal 3 and a specified torsional moment (force) shall be applied similarly, to check the control part and other related sections for any deformation or breakage.

Push-pull Strength (Lever Push-pull Strength)

A specified force shall be applied in the axial direction of the shaft (lever) for 10 seconds to check the control part and other sections for any deformation or breakage and for operating condition.

Resistance Taper

Resistance Taper

With the shaft (lever) placed in the specified position, resistance taper shall be determined by measuring the voltage between the specified terminals (between terminals 1 and 2 or between terminals 2 and 3) and calculating the percentage in reference to the voltage between terminals 1 and 3.

Reference: Standard resistance tapers in reference to rotational angles (travels) are as shown below.

