



HESTORE.HU

elektronikai alkatrész áruház

EN: This Datasheet is presented by the manufacturer.

Please visit our website for pricing and availability at www.hestore.hu.

FERRITE MATERIAL: K5B(RMS-303)									
PARTNUMBER	A	B	C	IMPEDANCE (Ω)		STANDARD PACK			
				25MHz	100MHz				
				RT-30-10-20	3.00		2.00	1.00	20
RT-30-12-20			1.20	17	38				
RT-35-8-25	3.00	2.00	1	25	52				
RT-35-8-30			0.80	31	53				
RT-35-10-30			1.00	29	50				
RT-35-12-30			1.20	25	45				
RT-35-13-30			1.30	26	47				
RT-35-13-33	3.25	1.30	27	48	4000				
RT-35-14-30	3.50	3.00	1.40	26		49			
RT-35-14-33									
RT-35-15-15			1.54	1.50		15	36		
RT-35-15-30			3.00	1.50		21	42		
RT-35-15-33			3.30	1.50		21	43		
RT-35-17-30			3.00	1.70		17	38		
RT-35-18-13			1.30	1.80		11	31		
RT-35-18-30			3.00	1.80		18	37		
RT-39-23-25			3.94	2.54		2.29	15	36	2000
RT-40-15-20			4.00	2.00	1.50	19	39		
RT-40-15-30	3.00	23				45			
RT-40-20-15	1.50	13				35			
RT-40-20-20	2.00	14				37			
RT-40-20-30	3.00	20				41			
RT-40-22-17	1.70	2.20		12	31				
RT-41-16-40	4.10	4.00		1.60	31	55	2000		
RT-43-28-25	4.30	2.50		2.80	13	35	4000		
RT-44-28-14	4.40	1.40			12	32	5000		
RT-45-25-32	4.50	3.20		2.50	18	37	4000		
RT-50-20-20	5.00	2.00	2.00	17	37	2000			
RT-50-20-40				4.00	30		46		
RT-50-23-30				3.00	2.30		19	39	
RT-60-30-15				1.50	3.00		10	31	
RT-60-30-20				2.00			15	35	
RT-60-30-30	3.00	21	40						
RT-60-30-38	3.80	22	43						
RT-60-30-40	4.00	24	44						
RT-60-30-55	5.50		31	51	1000				
RT-65-43-60	6.50	6.00	4.30	21			42		
RT-70-35-40	7.00	4.00	3.50	23		46			
RT-70-35-60		6.00		34		59			
RT-73-33-43	7.30	4.30	3.30	27		50			
RT-75-24-40	7.50	4.00	2.40	32		62			
RT-76-52-62	7.60	6.20	5.20	21		40	500		
RT-79-40-70	7.90	7.00	4.00	33		57			
RT-80-31-40	8.00	4.00	3.10			52			
RT-80-40-30		3.00	17	37					
RT-80-40-40		4.00	4.00	23	46				
RT-80-40-60		6.00	33	57					
RT-80-60-50		5.00	6.00	15	36				

FERRITE MATERIAL K5B(RMS-303)							
PARTNUMBER	A	B	C	IMPEDANCE (Ω)		STANDARD PACK	
				25MHz	100MHz		
				RT-80-60-70	8.00		7.00
RT-85-50-30	8.50	3.00	5.00	16	34	1000	
RT-90-50-30	9.00			37			
RT-90-50-80		8.00		38	64	500	
RT-93-45-64	9.30	6.35	4.50	32	50	1000	
RT-94-63-72	9.40	7.20	6.30	22	42		
RT-95-46-46	9.50	4.57	4.60	27	47		
RT-95-48-33		3.30	4.80	22	45		
RT-95-50-48		4.80	5.00	26	49		
RT-95-50-50		5.00		26	49		
RT-100-30-60		6.00		3.00	50		82
RT-100-50-50	5.00	5.00	34	73	500		
RT-100-60-30	3.00	6.00	15	37			
RT-100-60-40	4.00		20	42			
RT-100-60-50	5.00		22	41			
RT-100-60-62	6.20		25	49			
RT-100-60-80	8.00		33	60			
RT-100-70-50	5.00	7.00	17	39		500	
RT-100-70-70	7.00	22	44				
RT-100-70-75	7.50	25	46				
RT-103-58-102	10.30	10.20	5.80	40			67
RT-110-50-90	11.00	9.00	5.00	60	107		200
RT-120-60-40	12.00	4.00	6.00	24	48	500	
RT-120-60-60		6.00		34	58		
RT-120-60-80		8.00		46	77		
RT-120-70-55		5.50		7.00	26		49
RT-120-70-60		6.00		28	48		
RT-125-80-64	12.50	6.35	8.00	24	46	200	
RT-125-80-120		12.00		36	58		
RT-127-79-64	12.70	6.35	7.90	26	68	500	
RT-130-70-30	13.00	3.00	7.00	17	39		
RT-130-70-55		5.50		27	50		
RT-130-70-60		6.00		28	51		
RT-130-70-70		7.00		32	56		
RT-130-71-127		12.70		7.10	60	106	
RT-140-80-50	14.00	5.00	8.00	26	50	500	
RT-140-80-70		7.00		28	50		
RT-140-90-50		5.00		9.00	19		37
RT-142-64-102	14.20	10.16	6.35	57	95	200	
RT-142-64-135		13.50		75	125		
RT-142-80-120		12.00		8.00	49		76
RT-145-102-80	14.50	8.00	10.20	29	69	100	
RT-150-105-120	15.00	12.00	10.50	37	62		
RT-159-79-143	15.88	14.27	7.87	79	121		
RT-160-80-120	16.00	12.00	8.00	59	95		
RT-160-90-120		12.00	9.00	55	87		
RT-160-100-70		7.00	10.00	32	71		

REV.	MODIFICATION.	DATE	DRN
01	NEW DRAWING	19/06/06	NJB
02	CO2010196	24/04/08	SF
03	CO2010845	20/10/09	OW
04	CO2010989	01/10/10	SF
05	CO2011049	26/01/11	SF
06	CO2011144	17/05/11	SF
07	CO2011253	16/04/12	SF
08	CO2011277	31/07/12	SF

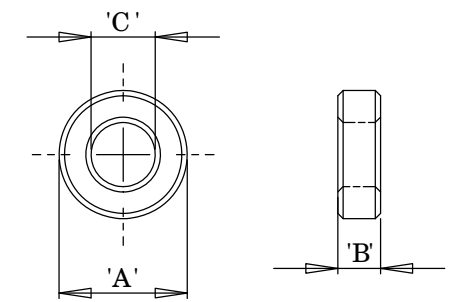
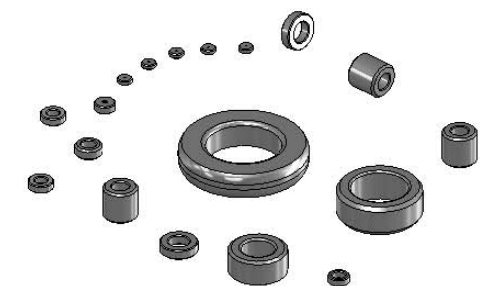

- NOTES.
- 1) See drawings 06-073 sheets 3 of 12 to 12 for Impedance graphs.
 - 2) Impedance figures are typical values.
 - 3) Other sizes available by special order.
 - 4) Packaging information is only a guide & subject to variation.

<small>INFORMATION CONTAINED IN THIS DOCUMENT IS CONFIDENTIAL TO RICHCO INTERNATIONAL Co. Ltd. AND MAY NOT BE DISCLOSED OR REPRODUCED IN WHOLE OR PART WITHOUT THEIR WRITTEN CONSENT.</small>			
RICHCO, INC. WWW.RICHCO-INC.COM		<small>ALL DIMENSIONS IN MM GENERAL TOLERANCES ±0.25 UNLESS OTHERWISE SPECIFIED 1 DECIMAL PLACE ± 2 DECIMAL PLACES ± ANGULAR ±1°</small>	<small>THIRD ANGLE</small>
MATERIAL: See Table		COLOR:	
DESCRIPTION: RT Toroid Cores.		PART No.: See Table	
DRG No.: 06-073	NPR No.:	Mass(g)	SHEET SIZE A3
DRN NJB	DATE 19/06/06	CHKD AS	DATE 19/06/06 SCALE NTS SHEET No. 1 OF 12

FERRITE MATERIAL: K5B(RMS-303)						
PARTNUMBER	A	B	IMPEDANCE (Ω)		STANDARD PACK	
			25MHz	100MHz		
RT-160-100-80	16.00	8.00	29	55	200	
RT-160-100-100		10.00	43	85	150	
RT-160-120-80		8.00	12.00	26	48	200
RT-160-120-150	15.00	33		58		
RT-165-82-130	16.50	13.00	70	125	120	
RT-165-82-160		16.00	83	140		
RT-165-92-75		7.50	9.2	35	70	200
RT-175-80-100	17.50	10.00	8.00	62	94	98
RT-175-95-50		5.00	10.00	22	44	200
RT-175-95-64		6.00	9.50	31	53	
RT-175-95-70		7.00		30	54	
RT-175-95-110		11.00		55	96	
RT-175-95-127		13.00		59	95	100
RT-175-95-135		14.00	63	115		
RT-175-95-150		15.00	70	113	112	
RT-175-107-80		8.00	10.70	33	60	200
RT-180-100-60		6.00	18.00	31	55	
RT-180-100-100	10.00	10.00		47	77	
RT-180-100-150	15.00	18.67	69	123	100	
RT-187-102-143	14.27		70	119		
RT-187-102-170	17.02		75	125		
RT-190-100-100	10.00	10.00	54	102	200	
RT-190-120-80	8.00	12.00	32	72		
RT-190-120-100	10.00	20.00	37	78	100	
RT-200-100-50	5.00		28	68	140	
RT-200-100-80	8.00	10.00	38	62	100	
RT-200-100-100	10.00	50	82			
RT-200-120-100	10.00	12.00	40	68	84	
RT-205-102-100	20.50	10.20	53	86	80	
RT-212-127-60	21.20	6.00	12.70	27	52	200
RT-220-135-64	6.35	13.50	28	53		
RT-220-135-80	8.00		37	78	100	
RT-220-140-65	7.00	14.00	28	68	84	
RT-220-140-80	8.00		33	73	100	
RT-220-140-100	10.00		42	90	84	
RT-220-140-120	12.00		40	85		
RT-221-137-127	22.10	12.70	13.72	48	83	100
RT-225-138-64	22.50	6.40	13.80	25	47	200
RT-225-138-127	12.70	23.00	46	71	50	
RT-230-135-64	6.35		13.50	28	53	200
RT-236-114-140	23.60	14.00	11.40	80	133	60
RT-236-150-60	6.00	15.00	26	70	72	
RT-236-150-114	11.00		43	85	100	
RT-250-150-80	8.00		38	79		
RT-250-150-100	10.00	44	87	50		
RT-250-150-120	12.00	53	97	60		
RT-250-150-150	15.00	61	105			
RT-254-127-64	25.40	6.35	12.70	39	80	100
RT-259-128-213	25.91	21.30	12.80	106	174	40
RT-260-130-127	26.00	12.70	13.00	74	125	50

FERRITE MATERIAL: K5B(RMS-303)						
PARTNUMBER	B	A	C	IMPEDANCE (Ω)		STANDARD PACK
				25MHz	100MHz	
RT-280-160-75	28.00	7.50	16.00	33	59	100
RT-280-160-130		13.00		55	100	
RT-280-160-170		17.00		71	120	
RT-280-160-200	20.00	29.00	19.00	85	155	40
RT-290-190-75	7.50			26	70	100
RT-290-190-77	7.70	31.00	19.00	33	76	50
RT-290-190-138	13.80			46	94	
RT-310-190-70	7.00			35	77	40
RT-310-190-80	8.00	30	55			
RT-310-190-160	16.00	36.00	25.00	68	115	32
RT-310-190-222	22.00			88	146	
RT-360-250-70	7.00	40.60	15.00	23	63	36
RT-360-250-127	13.00			39	84	24
RT-406-274-150	15.00	27.40	55	106	18	
RT-594-348-128	59.40	12.80	34.80	58	118	10

REV.	MODIFICATION.	DATE	DRN
01	NEW DRAWING	19/06/06	NJB
02	CO2010196	24/04/08	SF
03	CO2010845	20/10/09	OW
04	CO2010989	01/10/10	SF
05	CO2011049	26/01/11	SF
06	CO2011144	17/05/11	SF
07	CO2011253	16/04/12	SF
08	CO2011277	31/07/12	SF

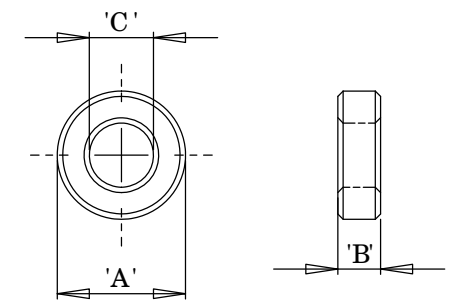

- NOTES.
- 1) See drawings 06-073 sheets 3 of 12 to 12 for Impedance graphs.
 - 2) Impedance figures are typical values.
 - 3) Other sizes available by special order.
 - 4) Packaging information is only a guide & subject to variation.

<small>INFORMATION CONTAINED IN THIS DOCUMENT IS CONFIDENTIAL TO RICHCO INTERNATIONAL Co., Ltd. AND MAY NOT BE DISCLOSED OR REPRODUCED IN WHOLE OR PART WITHOUT THEIR WRITTEN CONSENT.</small>					
RICHCO, INC. WWW.RICHCO-INC.COM		<small>ALL DIMENSIONS IN MM GENERAL TOLERANCES ±0.25 UNLESS OTHERWISE SPECIFIED 1 DECIMAL PLACE ± 2 DECIMAL PLACES ± ANGULAR ±1°</small>		<small>THIRD ANGLE</small> 	
MATERIAL: See Table			COLOR:		
DESCRIPTION: RT Toroid Cores.			PART No.: See Table		
DRG No.: 06-073		NPR No.:		Mass(g)	SHEET SIZE A3
DRN NJB	DATE 19/06/06	CHKD AS	DATE 19/06/06	SCALE NTS	SHEET No. 2 OF 12

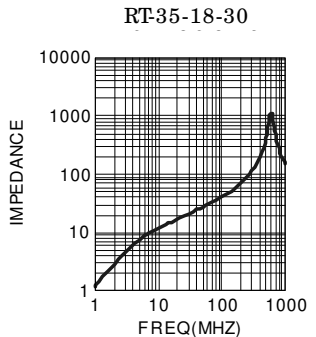
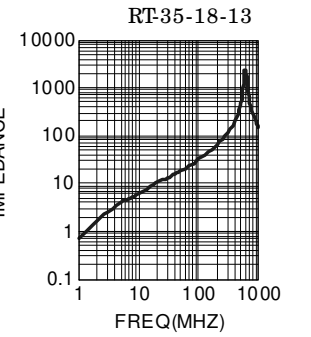
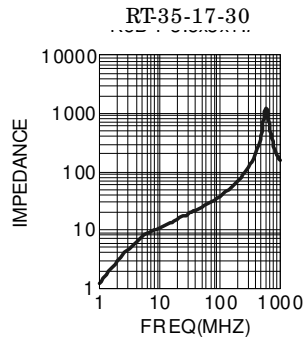
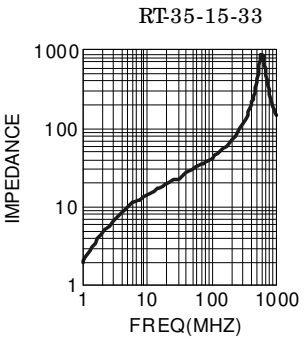
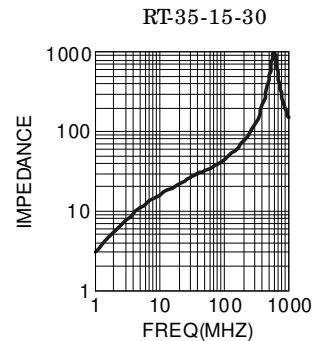
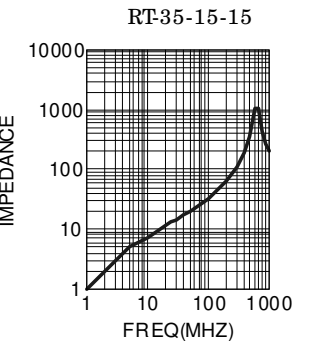
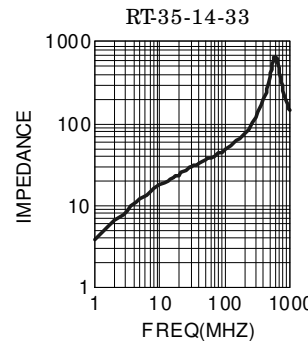
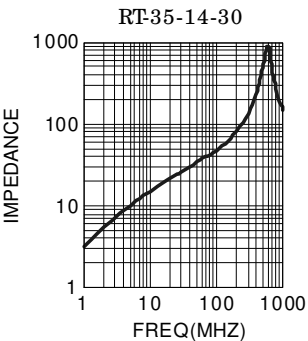
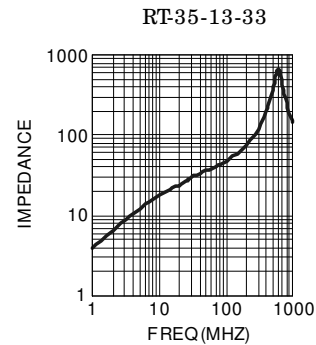
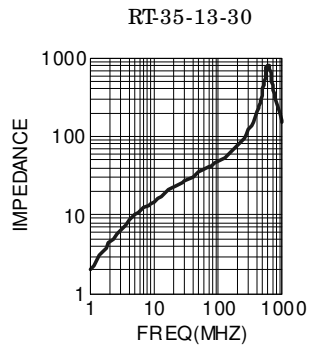
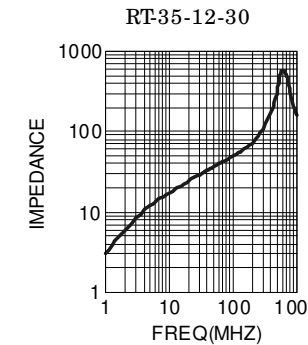
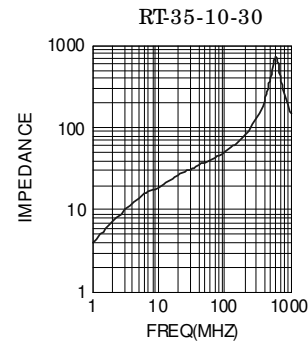
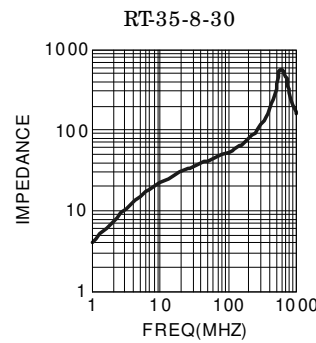
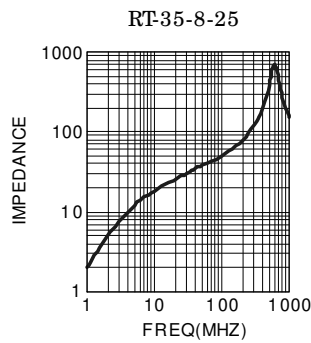
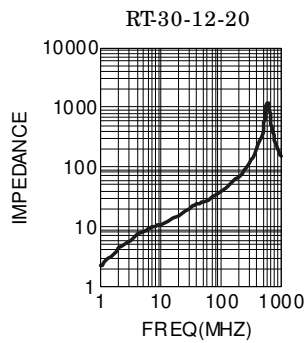
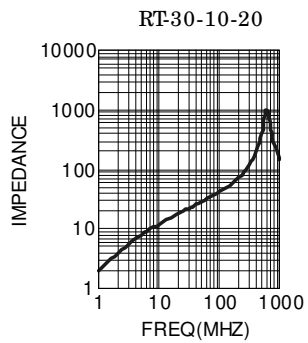

REV.	MODIFICATION.	DATE	DRN
01	NEW DRAWING	19/06/06	NJB
02	CO2010196	24/04/08	SF
03	CO2010845	20/10/09	OW
04	CO2010989	01/10/10	SF
05	CO2011049	26/01/11	SF
06	CO2011144	17/05/11	SF
07	CO2011253	16/04/12	SF
08	CO2011277	31/07/12	SF

NOTES.
1) Impedance figures are typical values.

INFORMATION CONTAINED IN THIS DOCUMENT IS CONFIDENTIAL TO RICHCO INTERNATIONAL Co., Ltd. AND MAY NOT BE DISCLOSED OR REPRODUCED IN WHOLE OR PART WITHOUT THEIR WRITTEN CONSENT.

RICHCO, INC.
WWW.RICHCO-INC.COM

DESCRIPTION:
RT Toroid Cores, Impedance Graphs.

DRG No: 06-073		SHEET SIZE A3	
DRN NJB	DATE 30/05/06	CHKD AS	DATE 30/05/06
SCALE NTS		SHEET No. 3 OF 12	

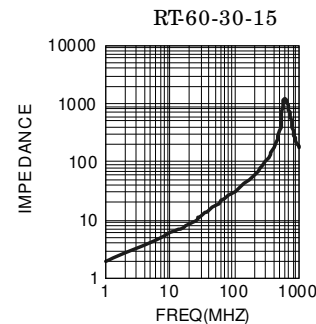
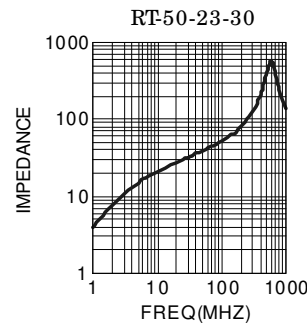
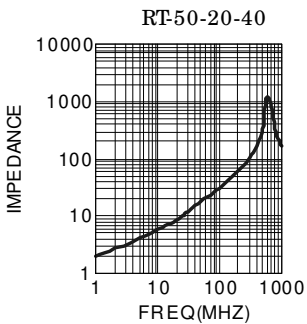
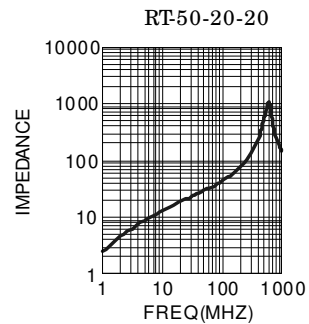
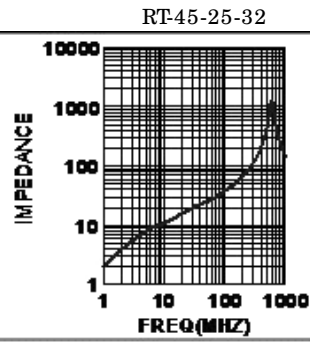
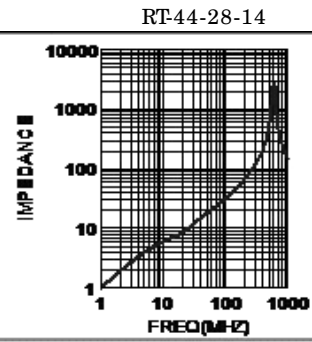
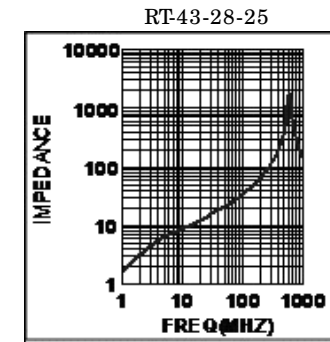
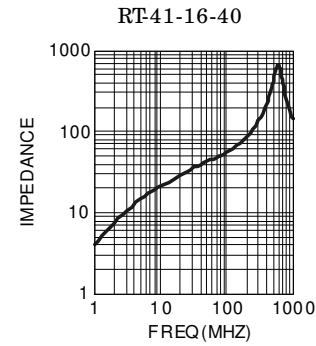
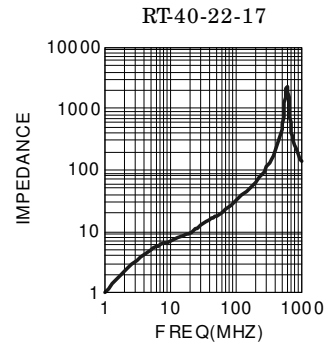
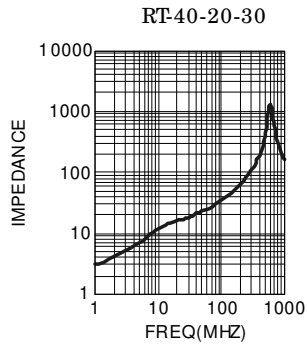
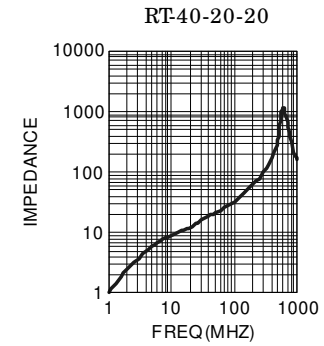
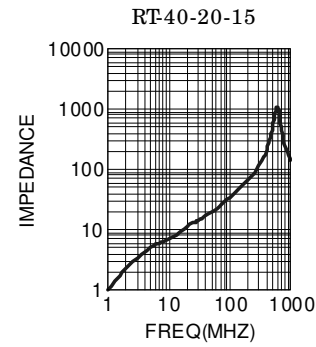
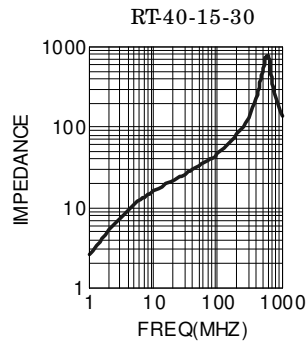
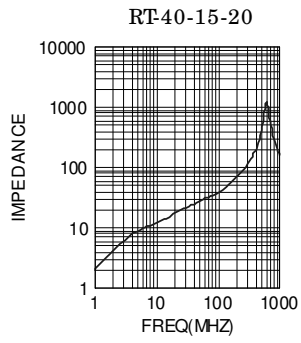
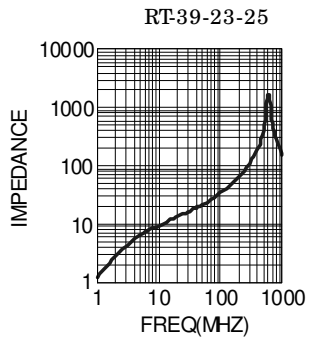

REV.	MODIFICATION.	DATE	DRN
01	NEW DRAWING	19/06/06	NJB
02	CO2010196	24/04/08	SF
03	CO2010845	20/10/09	OW
04	CO2010989	01/10/10	SF
05	CO2011049	26/01/11	SF
06	CO2011144	17/05/11	SF
07	CO2011253	16/04/12	SF
08	CO2011277	31/07/12	SF

NOTES.
1) Impedance figures are typical values.

INFORMATION CONTAINED IN THIS DOCUMENT IS CONFIDENTIAL TO RICHCO INTERNATIONAL Co., Ltd. AND MAY NOT BE DISCLOSED OR REPRODUCED IN WHOLE OR PART WITHOUT THEIR WRITTEN CONSENT.

RICHCO, INC.
WWW.RICHCO-INC.COM

DESCRIPTION:
RT Toroid Cores, Impedance Graphs.

DRG No: 06-073		SHEET SIZE A3	
DRN NJB	DATE 30/05/06	CHKD AS	DATE 30/05/06
SCALE NTS		SHEET No. 4 OF 12	

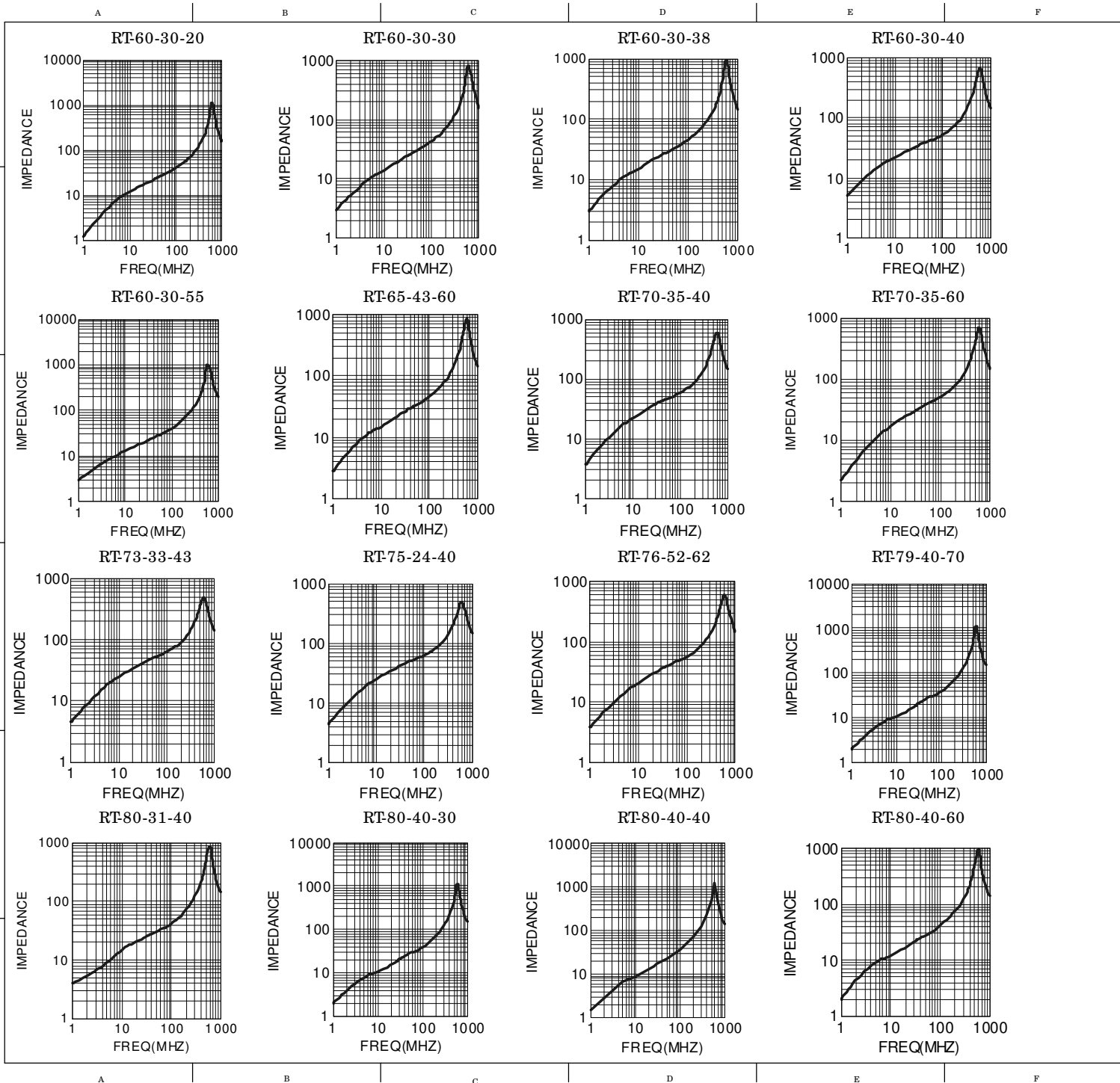

REV.	MODIFICATION.	DATE	DRN
01	NEW DRAWING	19/06/06	NJB
02	CO2010196	24/04/08	SF
03	CO2010845	20/10/09	OW
04	CO2010989	01/10/10	SF
05	CO2011049	26/01/11	SF
06	CO2011144	17/05/11	SF
07	CO2011253	16/04/12	SF
08	CO2011277	31/07/12	SF

NOTES.
1) Impedance figures are typical values.

INFORMATION CONTAINED IN THIS DOCUMENT IS CONFIDENTIAL TO RICHCO INTERNATIONAL Co., Ltd. AND MAY NOT BE DISCLOSED OR REPRODUCED IN WHOLE OR PART WITHOUT THEIR WRITTEN CONSENT.

RICHCO, INC.
WWW.RICHCO-INC.COM

DESCRIPTION:
RT Toroid Cores, Impedance Graphs.

DRG No: 06-073		SHEET SIZE A3	
DRN NJB	DATE 30/05/06	CHKD AS	DATE 30/05/06
SCALE NTS		SHEET No. 5 OF 12	

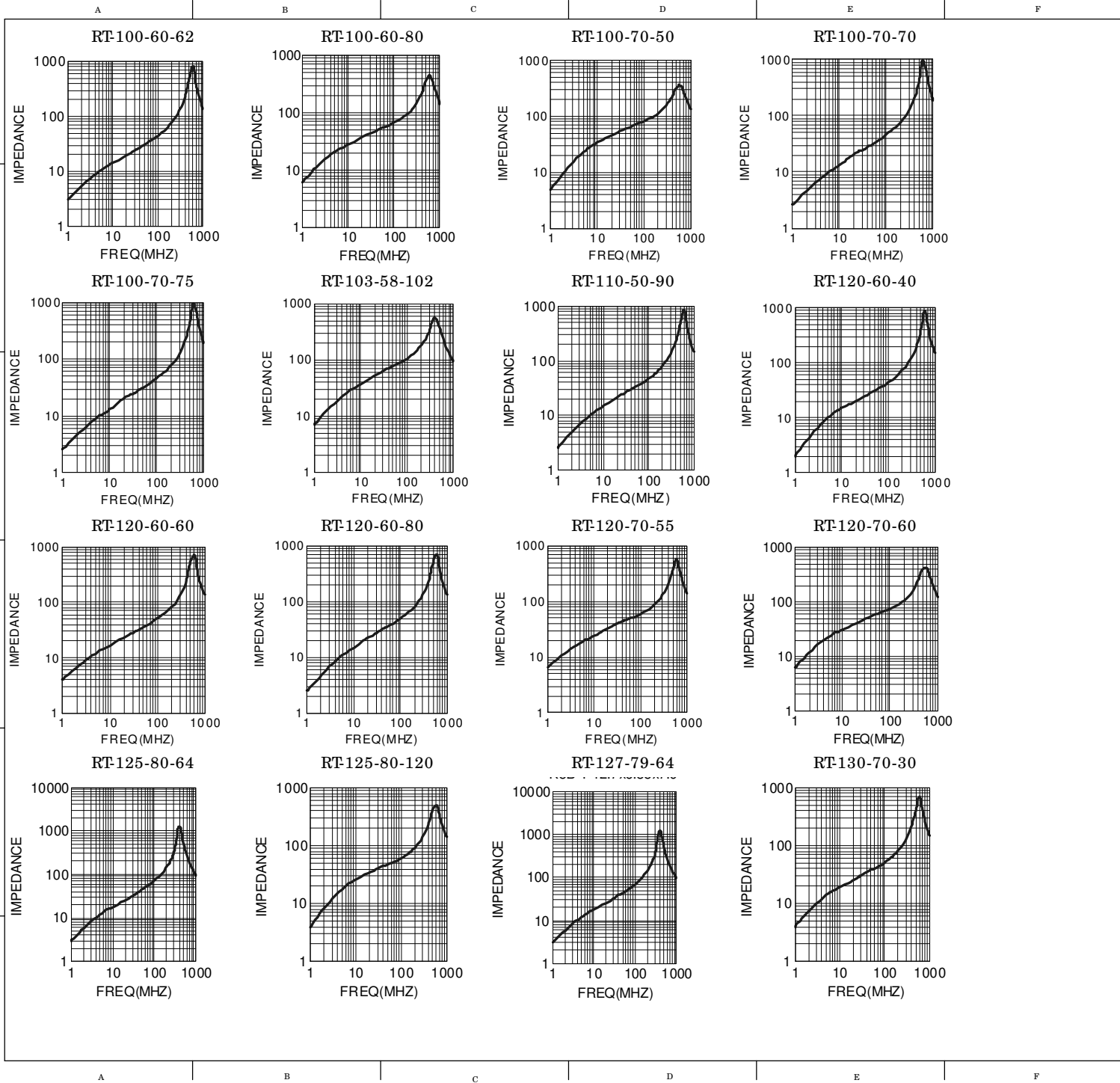

REV.	MODIFICATION.	DATE	DRN
01	NEW DRAWING	19/06/06	NJB
02	CO2010196	24/04/08	SF
03	CO2010845	20/10/09	OW
04	CO2010989	01/10/10	SF
05	CO2011049	26/01/11	SF
06	CO2011144	17/05/11	SF
07	CO2011253	16/04/12	SF
08	CO2011277	31/07/12	SF

NOTES.
1) Impedance figures are typical values.

INFORMATION CONTAINED IN THIS DOCUMENT IS CONFIDENTIAL TO RICHCO INTERNATIONAL Co., Ltd. AND MAY NOT BE DISCLOSED OR REPRODUCED IN WHOLE OR PART WITHOUT THEIR WRITTEN CONSENT.

RICHCO, INC.
WWW.RICHCO-INC.COM

DESCRIPTION:
RT Toroid Cores, Impedance Graphs.

DRG No: 06-073		SHEET SIZE A3		
DRN NJB	DATE 30/05/06	CHKD AS	DATE 30/05/06	SCALE NTS
SHEET No. 6 OF 12				

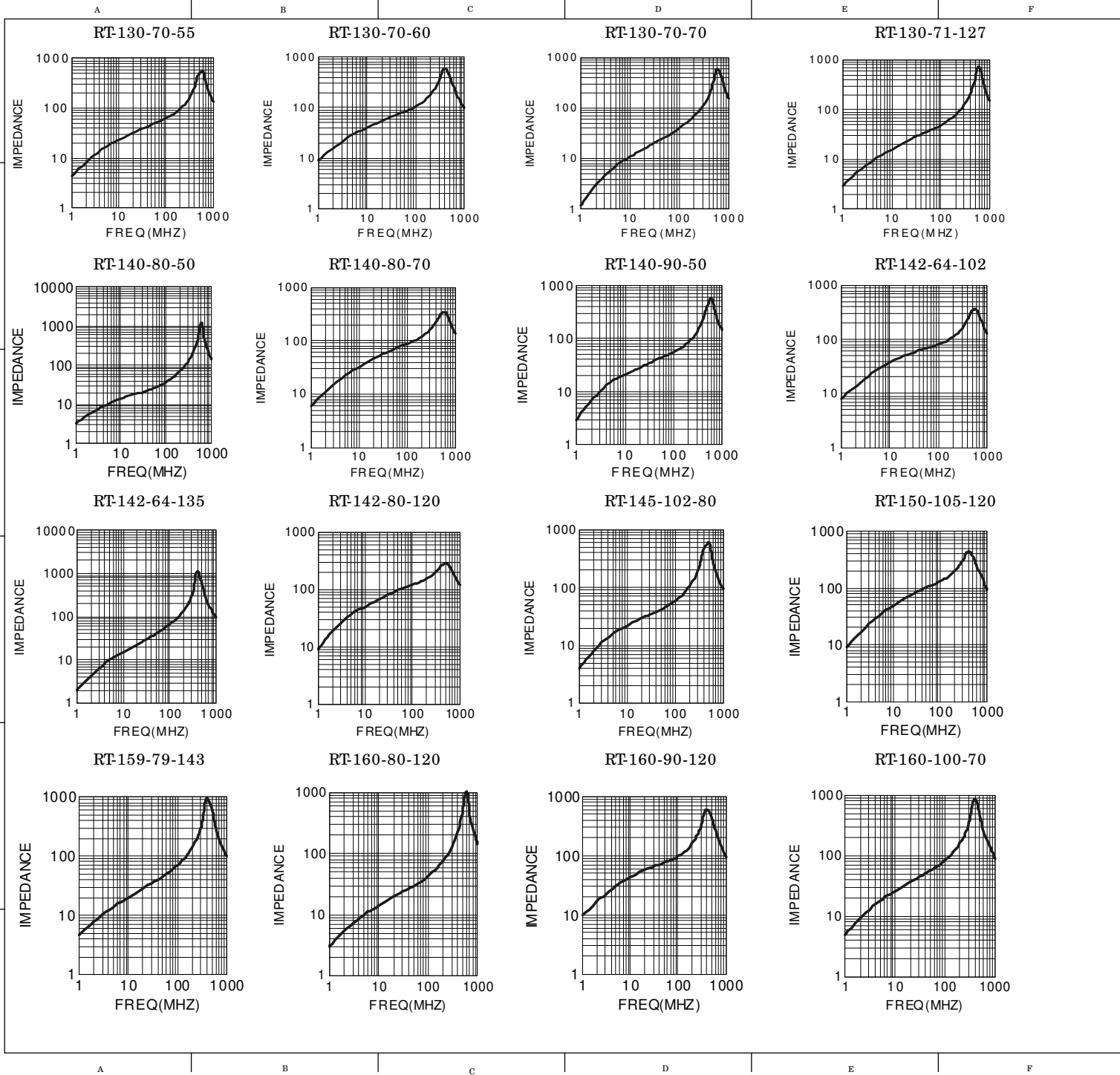

REV.	MODIFICATION.	DATE	DRN
01	NEW DRAWING	19/06/06	NJB
02	CO2010196	24/04/08	SF
03	CO2010845	20/10/09	OW
04	CO2010989	01/10/10	SF
05	CO2011049	26/01/11	SF
06	CO2011144	17/05/11	SF
07	CO2011253	16/04/12	SF
08	CO2011277	31/07/12	SF

NOTES.
 1) Impedance figures are typical values.

INFORMATION CONTAINED IN THIS DOCUMENT IS CONFIDENTIAL TO RICHCO INTERNATIONAL Co., Ltd. AND MAY NOT BE DISCLOSED OR REPRODUCED IN WHOLE OR PART WITHOUT THEIR WRITTEN CONSENT.

RICHCO, INC.
 WWW.RICHCO-INC.COM

DESCRIPTION:
 RT Toroid Cores, Impedance Graphs.

DRG No: 06-073		SHEET SIZE A3	
DRN NJB	DATE 30/05/06	CHKD AS	DATE 30/05/06
SCALE NTS		SHEET No. 7 OF 12	

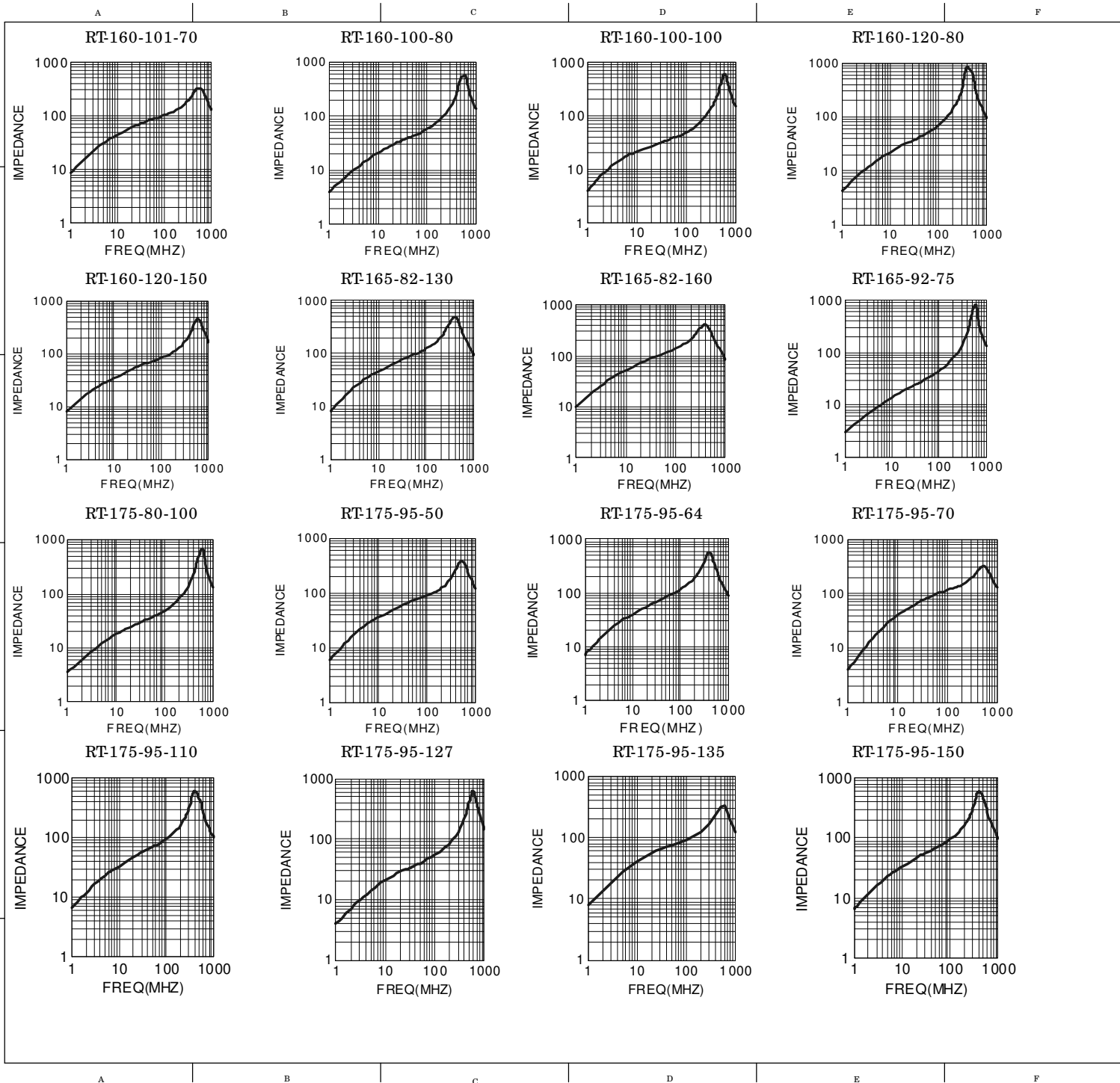

REV.	MODIFICATION.	DATE	DRN
01	NEW DRAWING	19/06/06	NJB
02	CO2010196	24/04/08	SF
03	CO2010845	20/10/09	OW
04	CO2010989	01/10/10	SF
05	CO2011049	26/01/11	SF
06	CO2011144	17/05/11	SF
07	CO2011253	16/04/12	SF
08	CO2011277	31/07/12	SF

NOTES.
1) Impedance figures are typical values.

INFORMATION CONTAINED IN THIS DOCUMENT IS CONFIDENTIAL TO RICHCO INTERNATIONAL Co., Ltd. AND MAY NOT BE DISCLOSED OR REPRODUCED IN WHOLE OR PART WITHOUT THEIR WRITTEN CONSENT.

RICHCO, INC.
WWW.RICHCO-INC.COM

DESCRIPTION:
RT Toroid Cores, Impedance Graphs.

DRG No: 06-073		SHEET SIZE A3	
DRN NJB	DATE 30/05/06	CHKD AS	DATE 30/05/06
SCALE NTS		SHEET No. 8 OF 12	

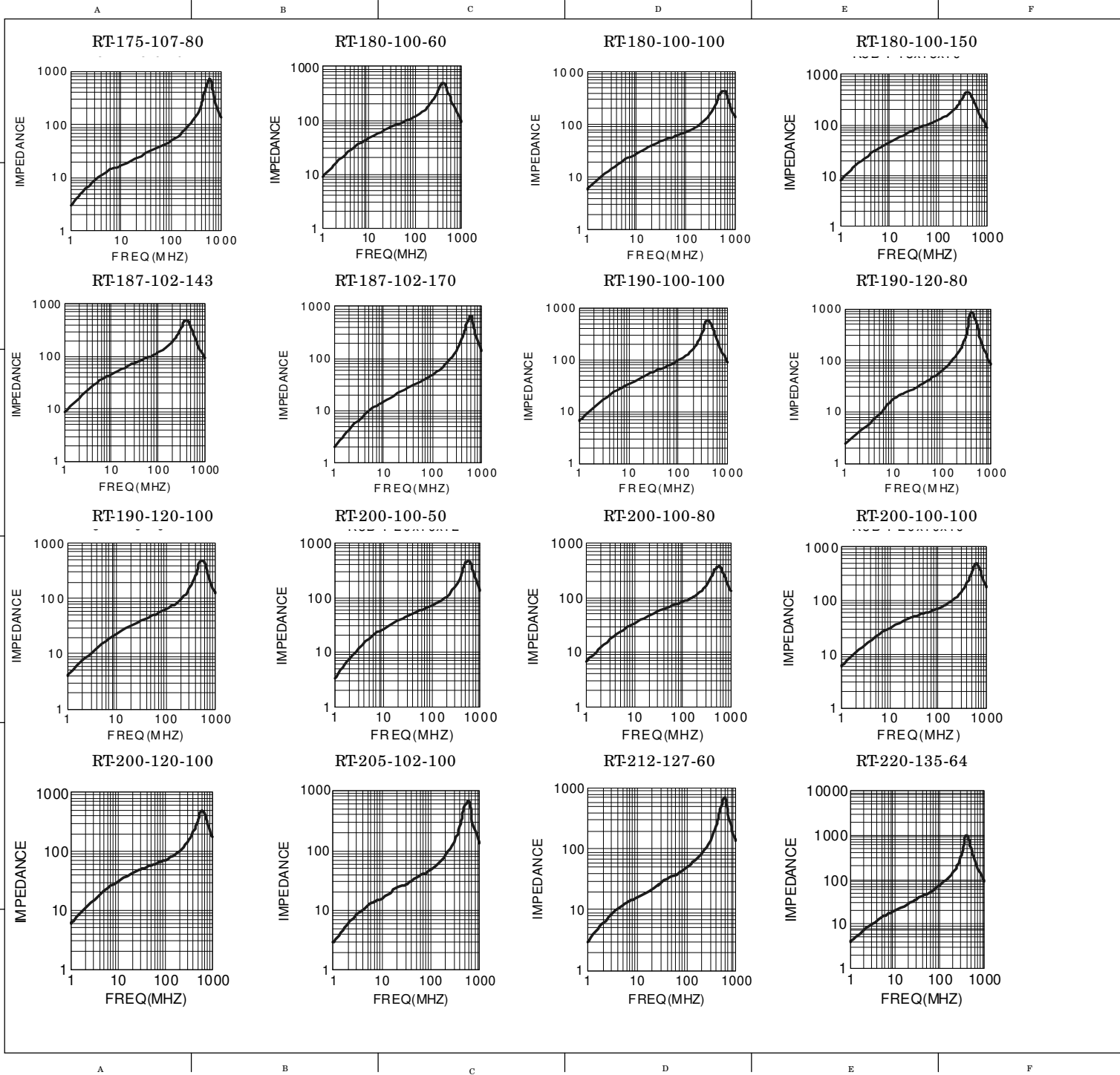

REV.	MODIFICATION.	DATE	DRN
01	NEW DRAWING	19/06/06	NJB
02	CO2010196	24/04/08	SF
03	CO2010845	20/10/09	OW
04	CO2010989	01/10/10	SF
05	CO2011049	26/01/11	SF
06	CO2011144	17/05/11	SF
07	CO2011253	16/04/12	SF
08	CO2011277	31/07/12	SF

NOTES.
1) Impedance figures are typical values.

INFORMATION CONTAINED IN THIS DOCUMENT IS CONFIDENTIAL TO RICHCO INTERNATIONAL Co., Ltd. AND MAY NOT BE DISCLOSED OR REPRODUCED IN WHOLE OR PART WITHOUT THEIR WRITTEN CONSENT.

RICHCO, INC.
WWW.RICHCO-INC.COM

DESCRIPTION:
RT Toroid Cores, Impedance Graphs.

DRG No: 06-073		SHEET SIZE A3	
DRN NJB	DATE 30/05/06	CHKD AS	DATE 30/05/06
SCALE NTS		SHEET No. 9 OF 12	

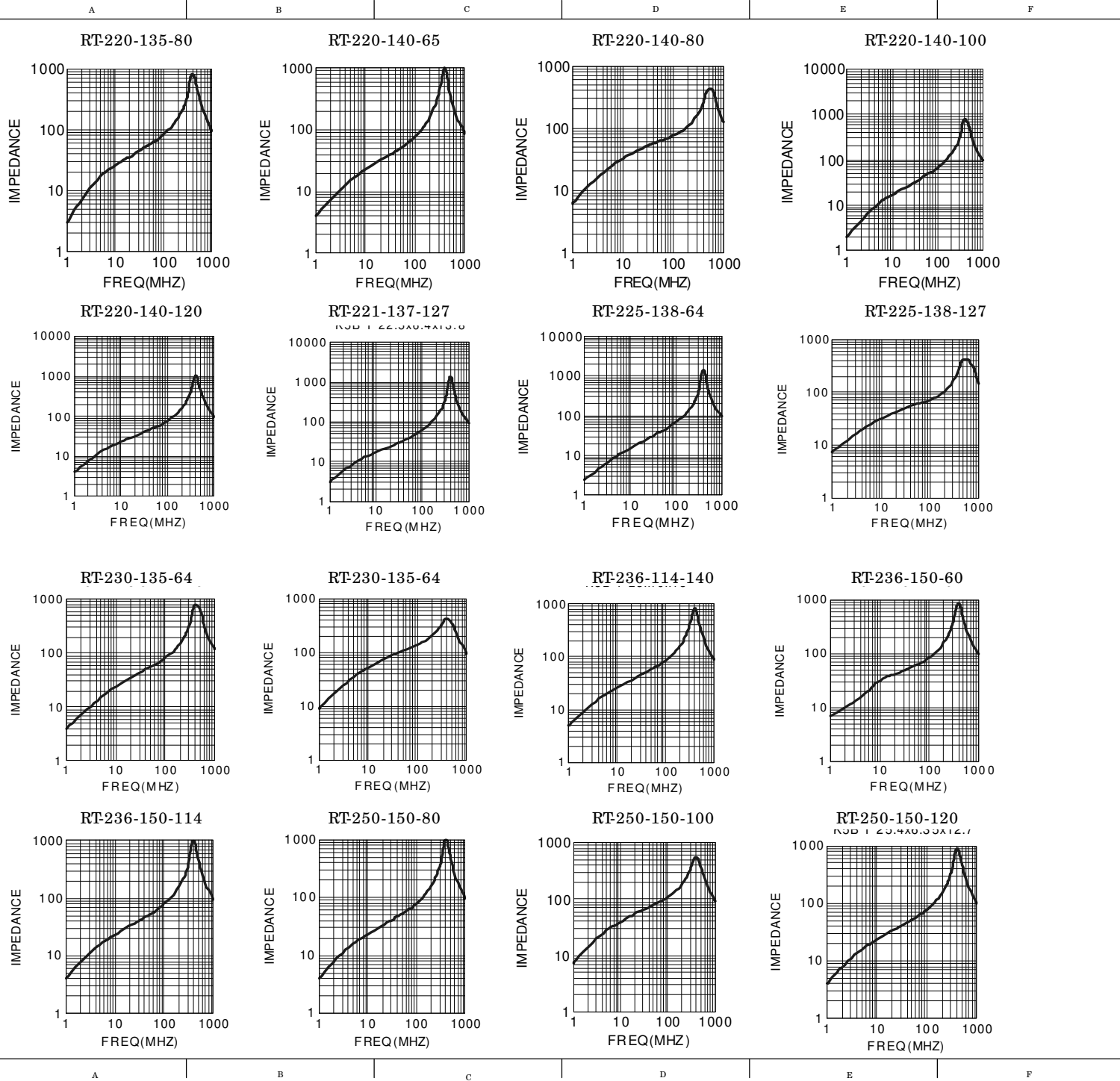

REV.	MODIFICATION.	DATE	DRN
01	NEW DRAWING	19/06/06	NJB
02	CO2010196	24/04/08	SF
03	CO2010845	20/10/09	OW
04	CO2010989	01/10/10	SF
05	CO2011049	26/01/11	SF
06	CO2011144	17/05/11	SF
07	CO2011253	16/04/12	SF
08	CO2011277	31/07/12	SF

NOTES.
1) Impedance figures are typical values.

INFORMATION CONTAINED IN THIS DOCUMENT IS CONFIDENTIAL TO RICHCO INTERNATIONAL Co., Ltd. AND MAY NOT BE DISCLOSED OR REPRODUCED IN WHOLE OR PART WITHOUT THEIR WRITTEN CONSENT.

RICHCO, INC.
WWW.RICHCO-INC.COM

DESCRIPTION:
RT Toroid Cores, Impedance Graphs.

DRG No: 06-073		SHEET SIZE A3	
DRN NJB	DATE 30/05/06	CHKD AS	DATE 30/05/06
SCALE NTS		SHEET No. 10 OF 12	

REV.	MODIFICATION.	DATE	DRN
01	NEW DRAWING	19/06/06	NJB
02	CO2010196	24/04/08	SF
03	CO2010845	20/10/09	OW
04	CO2010989	01/10/10	SF
05	CO2011049	26/01/11	SF
06	CO2011144	17/05/11	SF
07	CO2011253	16/04/12	SF
08	CO2011277	31/07/12	SF

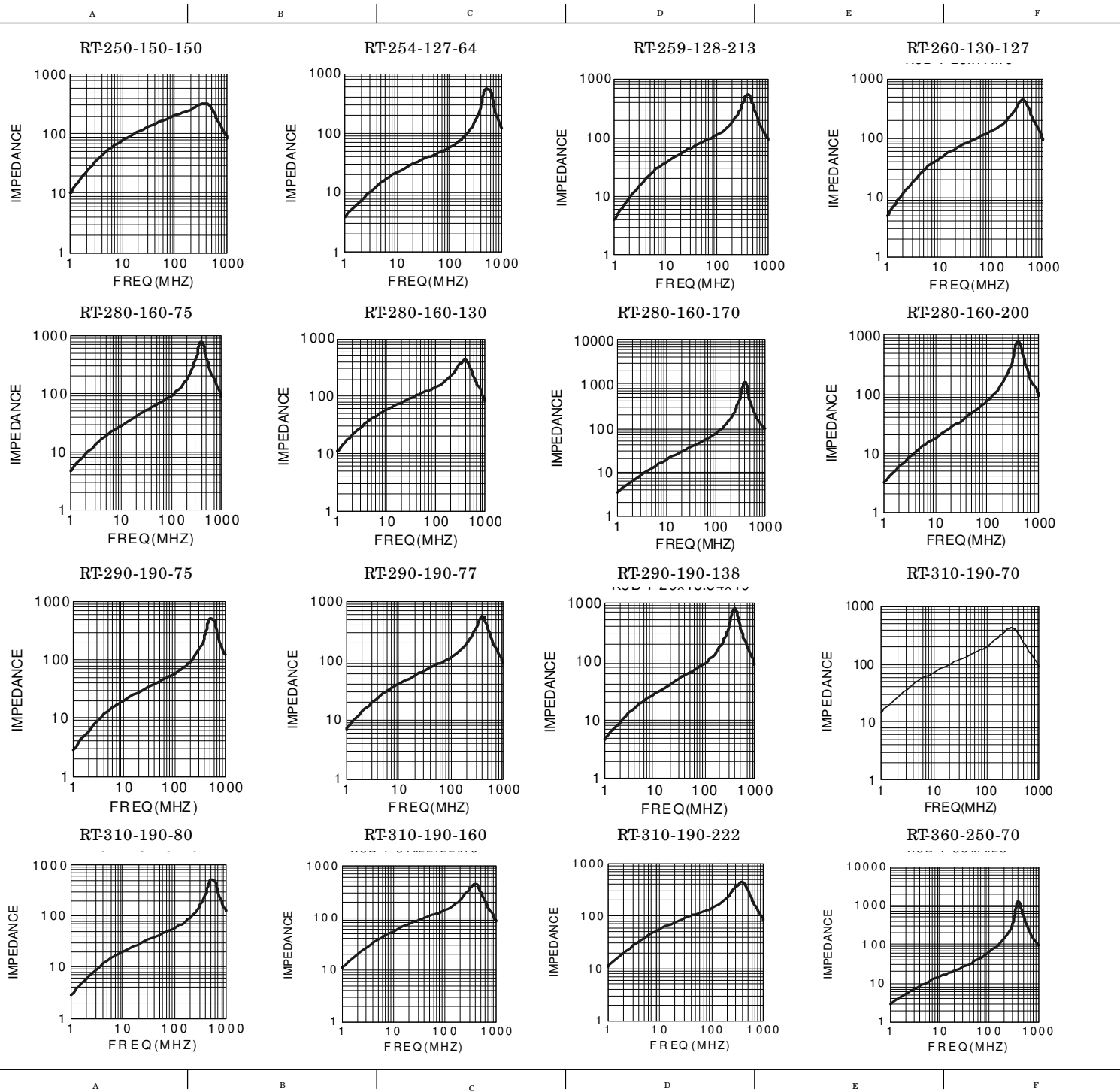

NOTES.
1) Impedance figures are typical values.

INFORMATION CONTAINED IN THIS DOCUMENT IS CONFIDENTIAL TO RICHCO INTERNATIONAL Co., Ltd. AND MAY NOT BE DISCLOSED OR REPRODUCED IN WHOLE OR PART WITHOUT THEIR WRITTEN CONSENT.

RICHCO, INC.
WWW.RICHCO-INC.COM

DESCRIPTION:
RT Toroid Cores, Impedance Graphs.

DRG No: 06-073		SHEET SIZE A3	
DRN NJB	DATE 30/05/06	CHKD AS	DATE 30/05/06
SCALE NTS		SHEET No. 11 OF 12	

RT-360-250-127

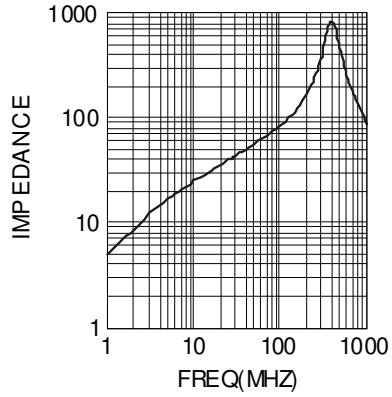

RT-406-274-150

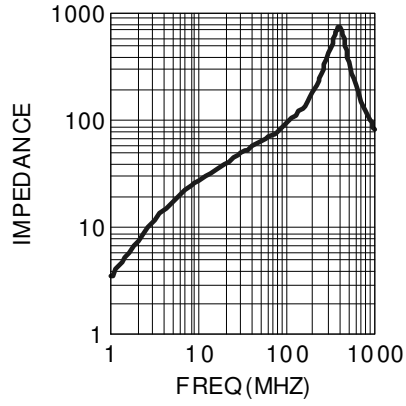

RT-594-348-128

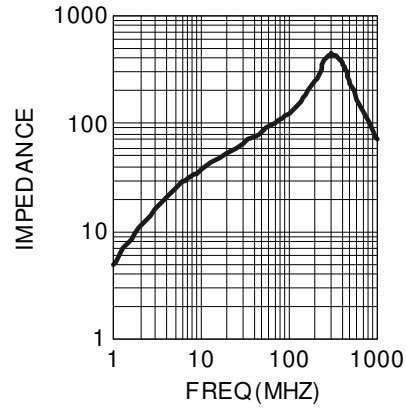

REV.	MODIFICATION.	DATE	DRN
01	NEW DRAWING	19/06/06	NJB
02	CO2010196	24/04/08	SF
03	CO2010845	20/10/09	OW
04	CO2010989	01/10/10	SF
05	CO2011049	26/01/11	SF
06	CO2011144	17/05/11	SF
07	CO2011253	16/04/12	SF
08	CO2011277	31/07/12	SF

NOTES.
1) Impedance figures are typical values.

INFORMATION CONTAINED IN THIS DOCUMENT IS CONFIDENTIAL TO RICHCO INTERNATIONAL Co., Ltd. AND MAY NOT BE DISCLOSED OR REPRODUCED IN WHOLE OR PART WITHOUT THEIR WRITTEN CONSENT.

RICHCO, INC.
WWW.RICHCO-INC.COM

DESCRIPTION:
RT Toroid Cores, Impedance Graphs.

DRG No: 06-073					SHEET SIZE A3
DRN NJB	DATE 30/05/06	CHKD AS	DATE 30/05/06	SCALE NTS	SHEET No. 12 OF 12