



HESTORE.HU

elektronikai alkatrész áruház

EN: This Datasheet is presented by the manufacturer.

Please visit our website for pricing and availability at www.hestore.hu.

PRODUCT SPECIFICATION

Model No.: FYS-23011DUHR-21-L4.0

Descriptions:
<ul style="list-style-type: none"> ■ 2.30 Inch Single Digit Display ■ Common Anode ■ Emitting Color : Ultra Hi Red ■ Chip Material:AlGaInP ■ Gray Face ■ White Segment



CUSTOMER APPROVED SIGNATURES	APPROVED BY	CHECKED BY	PREPARED BY

NINGBO FORYARD OPTOELECTRONICS CO.,LTD

Add:NO.115 Qixin Road Ningbo Zhejiang China

Zip:315051

Tel: 0086-574-87933652 87927870 87922206

Fax: 0086-574-87927917

E-mail:Sales@foryard.com (General)

Http://www.foryard.com

Model No.: FYS-23011DUHR-21-L4.0
■ Features -

1. 2.30 inch (56.80mm) digit height.
2. Case mold type.
3. RoHS compliant.
4. Low current operation
5. Low power consumption.
6. Easy mounting on P.C. board or socket.

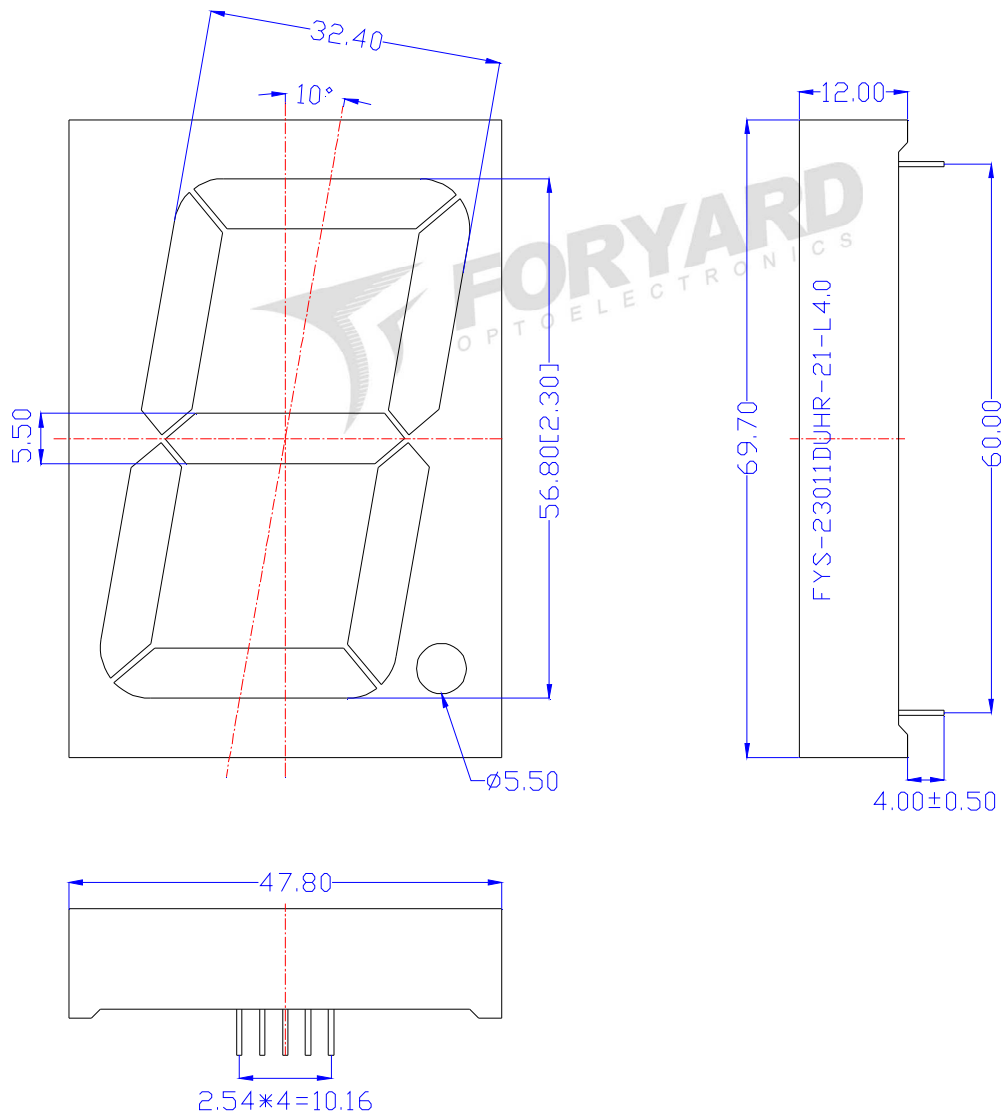
■ Mechanical Dimensions -

Notes:

1. All pins are $\phi 0.60$ [0.023] mm
2. Dimension in millimeter [inch], tolerance is ± 0.25 [0.010] and angle is $\pm 1^\circ$ unless otherwise noted.
3. Bending \leq Length * 1%.
4. The specifications, characteristics and technical data described in the datasheet are subject to change without prior notice.

Model No.: FYS-23011DUHR-21-L4.0

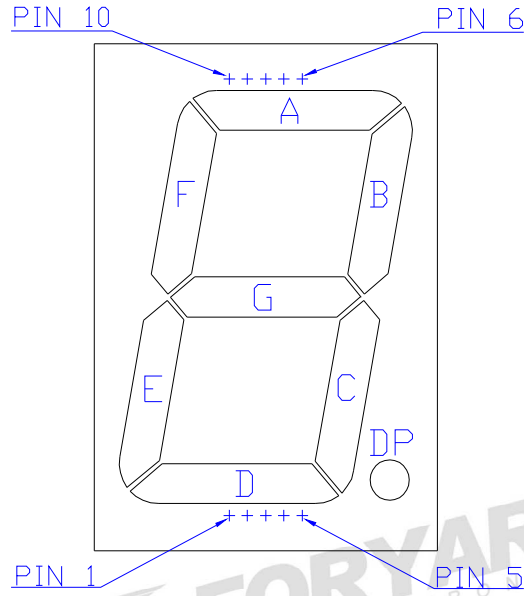
■ All Light On Segments Feature & Pin Position



■ Internal Circuit Diagrams -

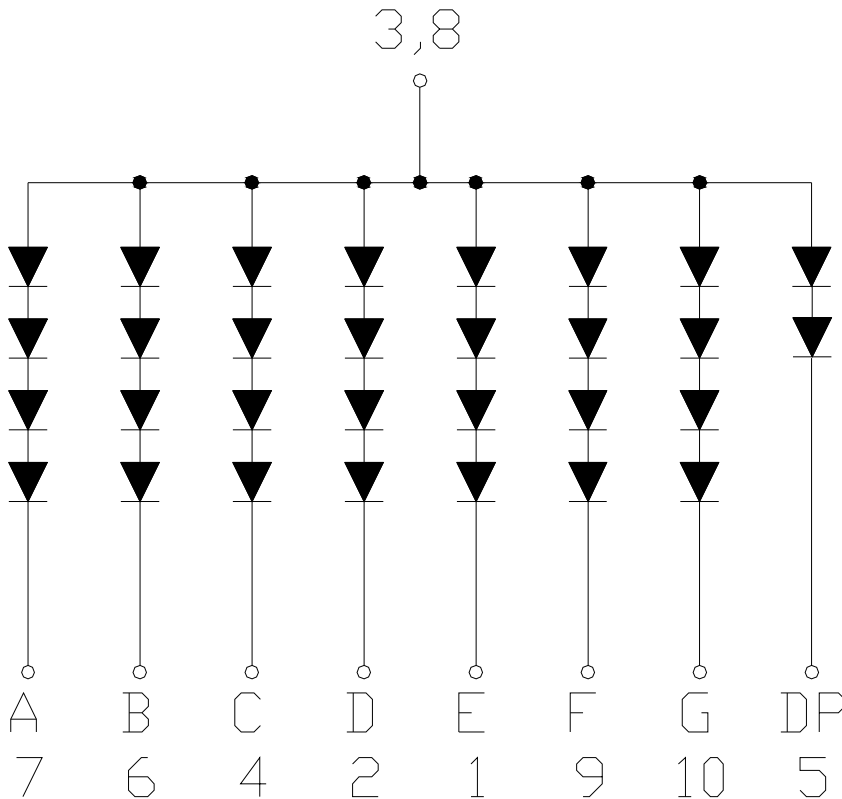

Model No.: FYS-23011DUHR-21-L4.0

■ **Absolute maximum ratings**

(Ta=25°C)

Parameter	Symbol	Test Condition	Value		Unit
			Min	Max	
Reverse Voltage	VR	IR=30	5	—	V
Forward Current	IF	—	—	30	mA
Power Dissipation	Pd	—	—	100	mW
Pulse Current	Ipeak	Duty=0.1mS,1KHz	—	150	mA
Operating Temperature	Topr	—	-40	+85	°C
Storage Temperature	Tstr	—	-40	+85	°C

■ **Electrical-Optical Characteristics**

● **Color Code & Chip Characteristics:(Test Condition:IF=20mA)**

(Ta=25°C)

Emitting Color		Dice Material	Peak Wave Length(λ_p)	Spectral Line halfwidth h($\Delta\lambda_{1/2}$)	Forward Voltage(VF) Unit:V		Luminous Intensity (Iv) Unit:mcd
					Typ	Max	
UHR	Ultra Hi Red	AlGaInP	640nm	20nm	1.90	2.50	30~60
Segment-to-Segment Luminous Intensity ratio(Iv-M)						1.5:1	

Note:

- 1.Luminous Intensity is based on the Foryard standards.
- 2.Pay attention about static for InGaN

Model No.: FYS-23011DUHR-21-L4.0

Typical Electrical / Optical Characteristics Curves

(Ta = 25°C Unless Otherwise Noted)

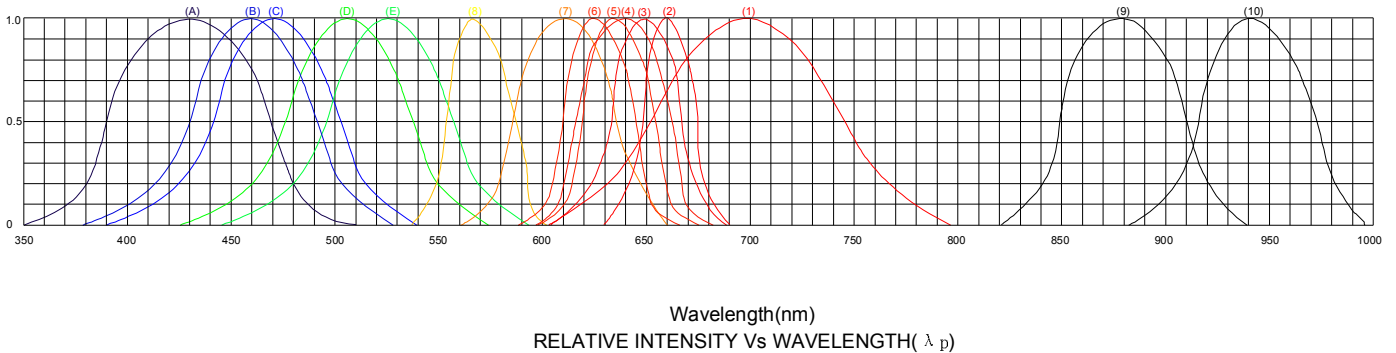

- (1)-GaP 700nm/Red
- (2)-AlGaAs/SH 660nm/Hi Red
- (3)-AlGaAs/DH 650nm/Super Red
- (4)-AlGaInP/640nm/Ultra Hi Red
- (5)-AlGaInP/635nm/Ultra Red
- (6)-GaAlP/AlGaInP/625nm/Orange
- (7)-GaAsP/AlGaInP 610nm/Amber
- (8)-GaP 570nm/Yellow Green
- (9)-GaAlAs 880nm
- (10)-GaAs/GaAs & GaAlAs/GaAs 940nm
- (A)-GaN/SiC 430nm/Blue
- (B)-InGaN/SiC 460nm/Blue
- (C)-InGaN/SiC 470nm/Blue
- (D)-InGaN/SiC 505nm/Ultra Green
- (E)-InGaN/SiC 525nm/Ultra Green

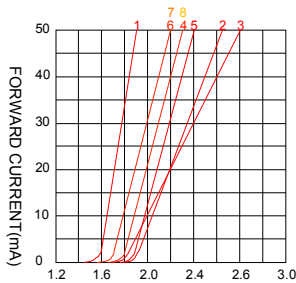

FORWARD VOLTAGE(Vf)
FORWARD CURRENT VS.
FORWARD VOLTAGE

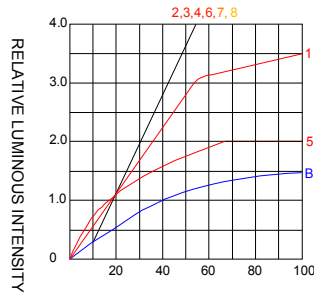

FORWARD CURRENT (mA)
RELATIVE LUMINOUS
INTENSITY VS FORWARD
CURRENT

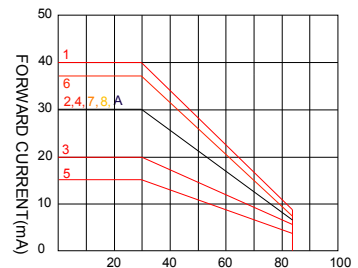

AMBIENT TEMPERATURE Ta(°C)
FORWARD CURRENT VS. AMBIENT
TEMPERATURE

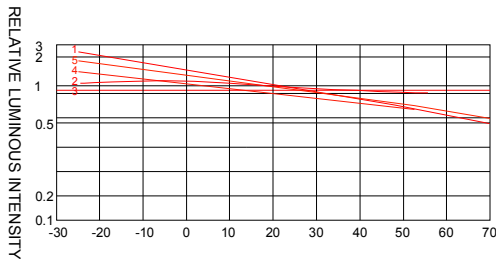

**AMBIENT TEMPERATURE
Ta(°C)**

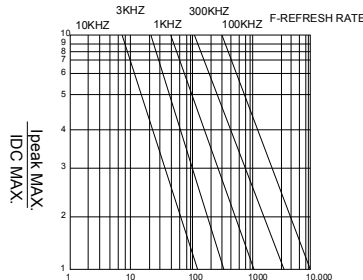

tp-PULSE DURATION μs
(1,2,3,4,6,8,B,D,J,K)

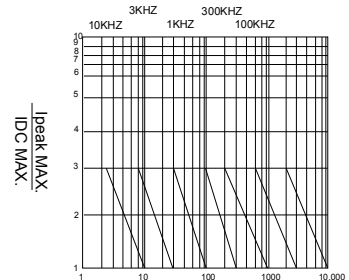

tp-PULSE DURATION μs
(5)

NOTE: 25°C free air temperature unless otherwise specified

Model No.: FYS-23011DUHR-21-L4.0

■ Precautions For Use -

1. Recommended Soldering conditions-Wave Soldering

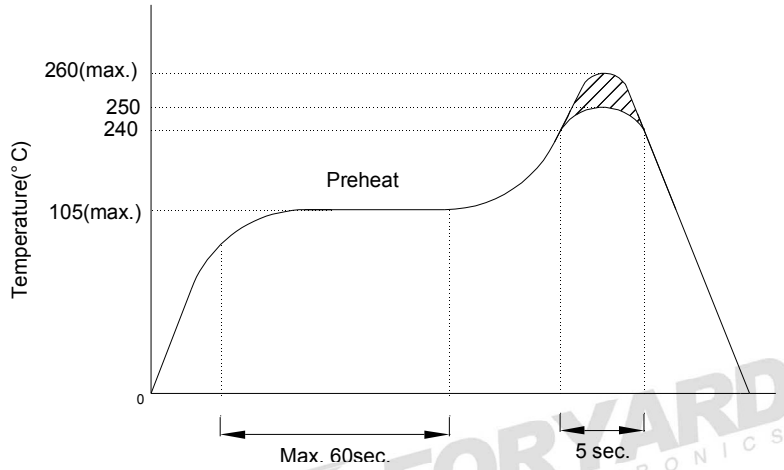

2. Soldering Iron

Basic SPEC. is $\leq 5\text{sec.}$ When 260°C . If temperature is higher, time should be shorter ($+10^{\circ}\text{C} \rightarrow -1\text{sec.}$).

Power dissipation of iron should be smaller than 15W, and temperature should be controllable.

Surface temperature of the device should be under 230°C .



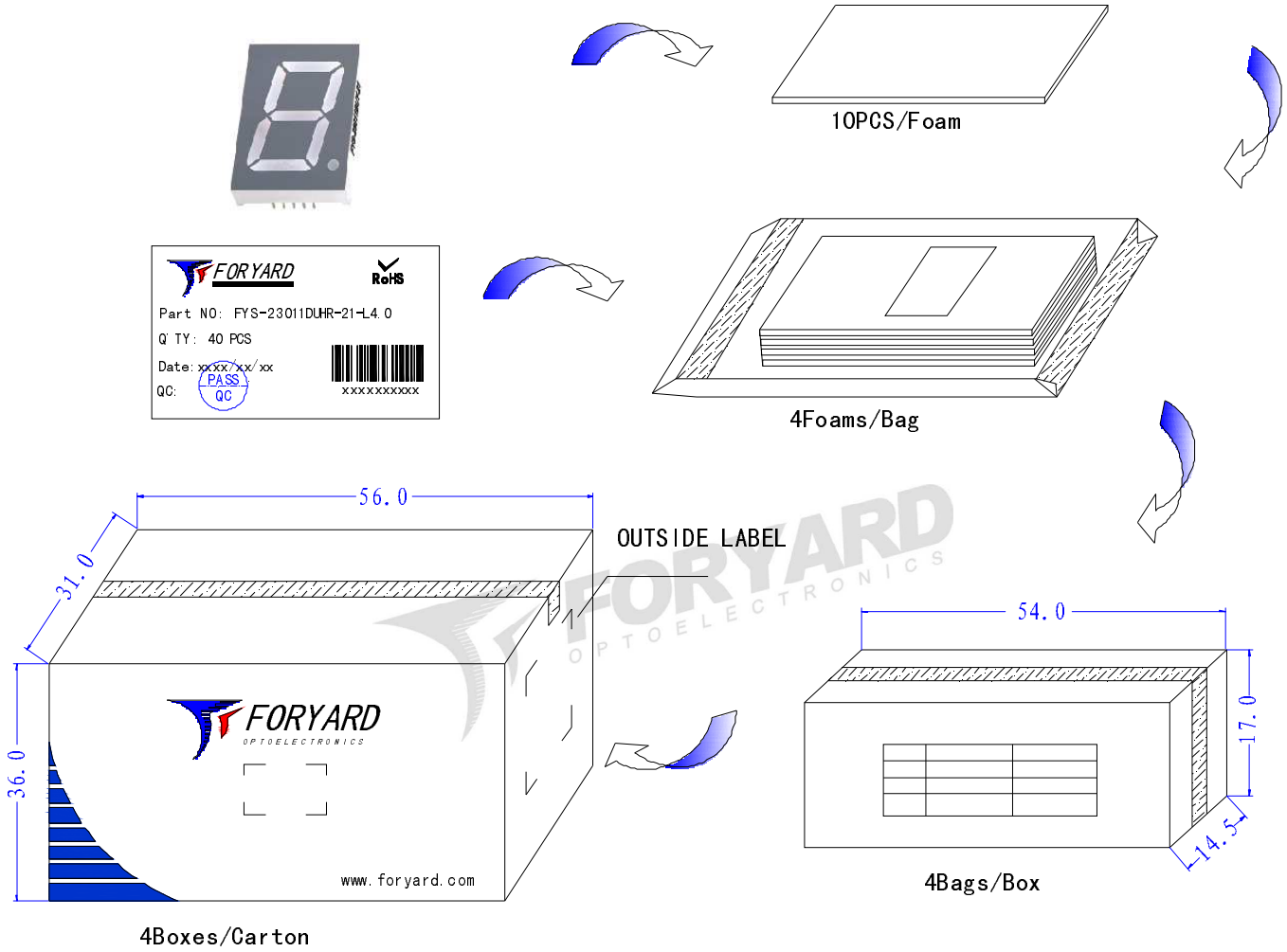

Model No.: FYS-23011DUHR-21-L4.0

■ Packing Diagram





 Part NO: FYS-23011DUHR-21-L4.0
 QTY: 40 PCS
 Date: xxxx/xx/xx
 QC:  
 xxxxxxxxxxxx

LED
 PN: FYS-23011DUHR-21-L4.0
 Qty: 560 PCS
 Date: xxxx/xx/xx
 GW: 25KG QC: 
 NW: 23KG
  
 xxxxxxxxxxxx

OUTSIDE LABEL

Note: The specifications are subject to change without notice. Please contact us for updated information.