



**HESTORE.HU**

elektronikai alkatrész áruház

**EN:** This Datasheet is presented by the manufacturer.

Please visit our website for pricing and availability at [www.hestore.hu](http://www.hestore.hu).

# D2F

## Ultra Subminiature Basic Switch

### Ultra Subminiature Basic Switch with plenty of terminal variations

- Incorporating a snapping mechanism made with two highly precise split springs that ensures long durability.
- Using insertion molded terminals that prevents flux penetration.
- In addition to self-clinching PCB, left-angled, right-angled terminals, 2 types of soldering terminals are available.

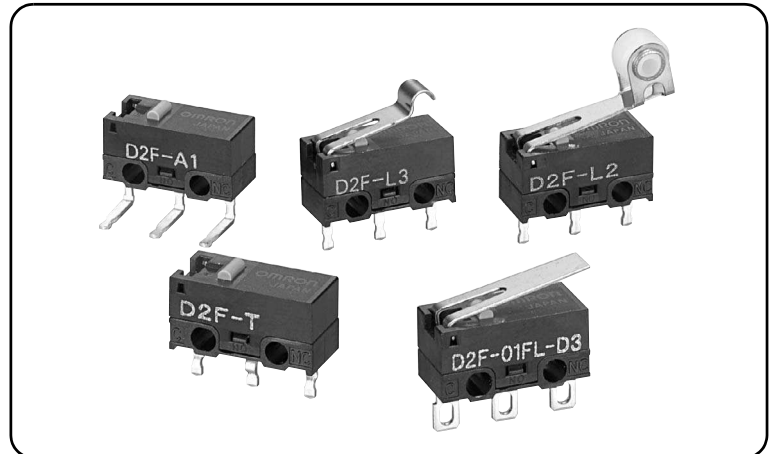

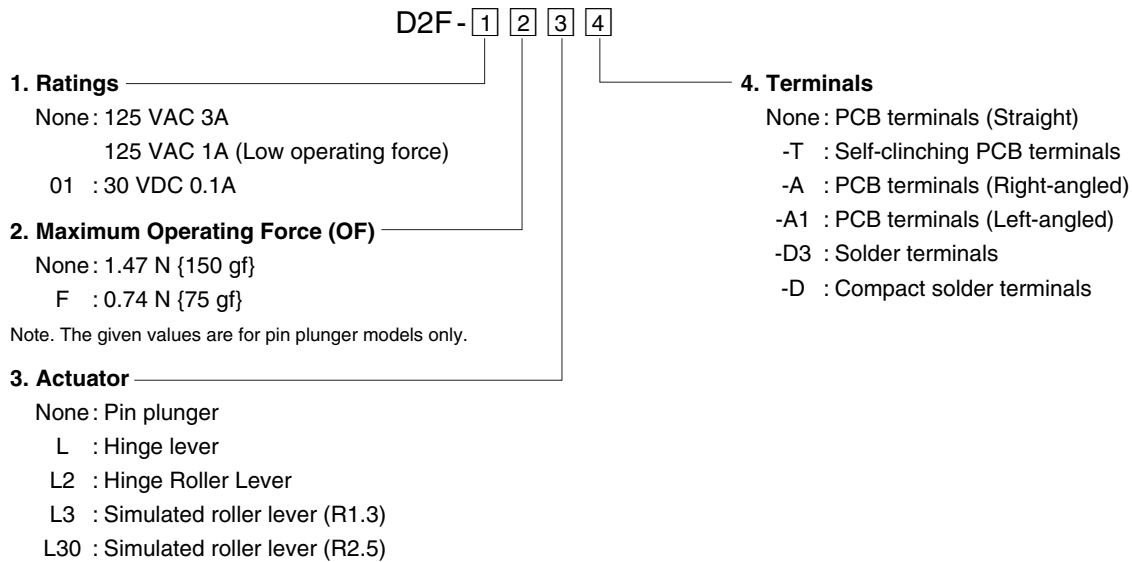

RoHS Compliant

### Model Number Legend



### List of Models

Actuator	Maximum Operating Force (OF) Terminals	Ratings		0.1 A	
		3 A General Purpose 1.47 N {150 gf}	1 A Low Operating Force 0.74 N {75 gf}	General Purpose 1.47 N {150 gf}	Low Operating Force 0.74 N {75 gf}
Pin plunger	PCB terminals (Standard)	D2F	D2F-F	D2F-01	D2F-01F
	Self-clinching PCB terminals	D2F-T	D2F-F-T	D2F-01-T	D2F-01F-T
	PCB terminals (Right-angled)	D2F-A	D2F-F-A	D2F-01-A	D2F-01F-A
	PCB terminals (Left-angled)	D2F-A1	D2F-F-A1	D2F-01-A1	D2F-01F-A1
	Solder terminals	D2F-D3	D2F-F-D3	D2F-01-D3	D2F-01F-D3
	Compact solder terminals	D2F-D	D2F-F-D	D2F-01-D	D2F-01F-D
Hinge lever	PCB terminals (Standard)	D2F-L	D2F-FL	D2F-01L	D2F-01FL
	Self-clinching PCB terminals	D2F-L-T	D2F-FL-T	D2F-01L-T	D2F-01FL-T
	PCB terminals (Right-angled)	D2F-L-A	D2F-FL-A	D2F-01L-A	D2F-01FL-A
	PCB terminals (Left-angled)	D2F-L-A1	D2F-FL-A1	D2F-01L-A1	D2F-01FL-A1
	Solder terminals	D2F-L-D3	D2F-FL-D3	D2F-01L-D3	D2F-01FL-D3
	Compact solder terminals	D2F-L-D	D2F-FL-D	D2F-01L-D	D2F-01FL-D

Actuator	Ratings Maximum Operating Force (OF) Terminals	3 A	1 A	0.1 A	
		General Purpose 1.47 N {150 gf}	Low Operating Force 0.74 N {75 gf}	General Purpose 1.47 N {150 gf}	Low Operating Force 0.74 N {75 gf}
 Hinge roller lever	PCB terminals (Standard)	D2F-L2	D2F-FL2	D2F-01L2	D2F-01FL2
	Self-clinching PCB terminals	D2F-L2-T	D2F-FL2-T	D2F-01L2-T	D2F-01FL2-T
	PCB terminals (Right-angled)	D2F-L2-A	D2F-FL2-A	D2F-01L2-A	D2F-01FL2-A
	PCB terminals (Left-angled)	D2F-L2-A1	D2F-FL2-A1	D2F-01L2-A1	D2F-01FL2-A1
	Solder terminals	D2F-L2-D3	D2F-FL2-D3	D2F-01L2-D3	D2F-01FL2-D3
	Compact solder terminals	D2F-L2-D	D2F-FL2-D	D2F-01L2-D	D2F-01FL2-D
 Simulated roller lever (R1.3)	PCB terminals (Standard)	D2F-L3	D2F-FL3	D2F-01L3	D2F-01FL3
	Self-clinching PCB terminals	D2F-L3-T	D2F-FL3-T	D2F-01L3-T	D2F-01FL3-T
	PCB terminals (Right-angled)	D2F-L3-A	D2F-FL3-A	D2F-01L3-A	D2F-01FL3-A
	PCB terminals (Left-angled)	D2F-L3-A1	D2F-FL3-A1	D2F-01L3-A1	D2F-01FL3-A1
	Solder terminals	D2F-L3-D3	D2F-FL3-D3	D2F-01L3-D3	D2F-01FL3-D3
	Compact solder terminals	D2F-L3-D	D2F-FL3-D	D2F-01L3-D	D2F-01FL3-D
 Simulated roller lever (R2.5)	PCB terminals (Standard)	D2F-L30	D2F-FL30	D2F-01L30	D2F-01FL30
	Self-clinching PCB terminals	D2F-L30-T	D2F-FL30-T	D2F-01L30-T	D2F-01FL30-T
	PCB terminals (Right-angled)	D2F-L30-A	D2F-FL30-A	D2F-01L30-A	D2F-01FL30-A
	PCB terminals (Left-angled)	D2F-L30-A1	D2F-FL30-A1	D2F-01L30-A1	D2F-01FL30-A1
	Solder terminals	D2F-L30-D3	D2F-FL30-D3	D2F-01L30-D3	D2F-01FL30-D3
	Compact solder terminals	D2F-L30-D	D2F-FL30-D	D2F-01L30-D	D2F-01FL30-D

## Contact Form

### ●SPDT

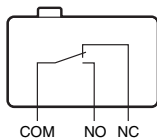

## Contact Specifications

Item	Model	D2F models	D2F-01 models
Contact	Specifications	Crossbar	
	Material	Silver alloy	Gold alloy
	Gap (standard value)	0.25 mm	
Minimum applicable load (see note) *		100 mA at 5 VDC	1 mA at 5 VDC

\* Please refer to "Using Micro Loads" in "Precautions" for more information on the minimum applicable load.

## Ratings

Model Maximum Operating Force (OF)	D2F models		D2F-01 models	
	1.47N (General-purpose)	0.74N (Low Operating Force)	1.47N (General-purpose)	0.74N (Low Operating Force)
Rated voltage	Resistive load			
125 VAC	3 A	1 A	-	
30 VDC	2 A	0.5 A	0.1 A	

Note. The above rating values apply under the following test conditions.

- (1) Ambient temperature: 20±2°C
- (2) Ambient humidity: 65±5%
- (3) Operating frequency: 30 operations/min

## Approved Safety Standard

The items shown in the "List of Models" above are not standard approved models.

Consult your OMRON sales representative for specific models with standard approvals.

**UL (UL1054) /CSA (CSA C22.2 No.55)**

Rated voltage	Model	D2F (General-purpose)	D2F (Low operating force)	D2F-01
125 VAC		3 A	1 A	-
30 VDC		2 A	0.5 A	0.1 A

## Characteristics

Item	Model	D2F-01 models	D2F-F models	D2F models
Permissible operating speed		Pin plunger models: 1 mm to 500 mm/s, Lever models: 5 mm to 500 mm/s		
Permissible operating frequency	Mechanical	Pin plunger models: 200 operations/min, Lever models: 100 operations/min		
	Electrical	30 operations/min		
Insulation resistance		100 MΩ min. (at 500 VDC with insulation tester)		
Contact resistance (initial value)		100 mΩ max.	50 mΩ max.	30 mΩ max.

Item	Model	D2F-01 models	D2F-F models	D2F models
Dielectric strength	Between terminals of the same polarity	600 VAC 50/60 Hz for 1min		
	Between current-carrying metal parts and ground	1,500 VAC 50/60 Hz for 1min		
	Between each terminal and non-current-carrying metal parts	1,500 VAC 50/60 Hz for 1min		
Vibration resistance * 1	Malfunction	10 to 55 Hz, 1.5-mm double amplitude		
Shock resistance	Durability	1,000 m/s <sup>2</sup> (approx. 100G) max.		
	Malfunction * 1	300 m/s <sup>2</sup> (approx. 30G) max.		
Durability * 2	Mechanical	1,000,000 operations min. (60 operations/min)		
	Electrical	100,000 operations min. (30 operations/min)	30,000 operations min. (30 operations/min)	
Degree of protection		IEC IP40		
Ambient operating temperature		-25°C to +85°C (at ambient humidity 60% max.) (with no icing or condensation)		
Ambient operating humidity		85% max. (for +5°C to +35°C)		
Weight		Approx. 0.5 g (pin plunger models)		

Note. The data given above are initial values.

\*1. The values are at Free Position and Total Travel Position values for pin plunger, and Total Travel Position value for lever. Close or open circuit of the contact is 1ms max.

\*2. For testing conditions, consult your OMRON sales representative.

## Terminals/Apearances (Unit: mm)

### ●PCB terminals (Straight)

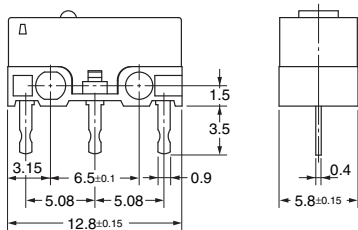

### ●Self-clinching PCB terminals

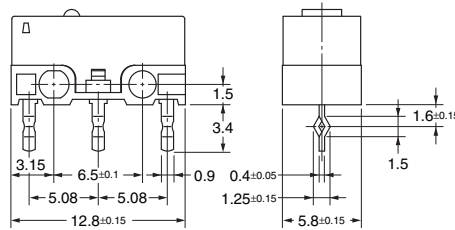

<PCB Mounting Dimensions (Reference)>

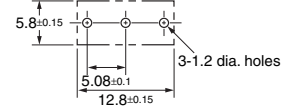

### ●PCB terminals (Right-angled)

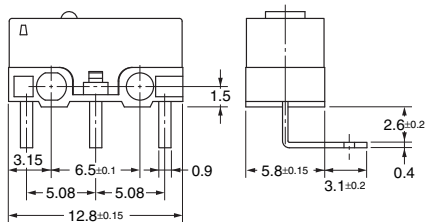

### ●PCB terminals (Left-angled)

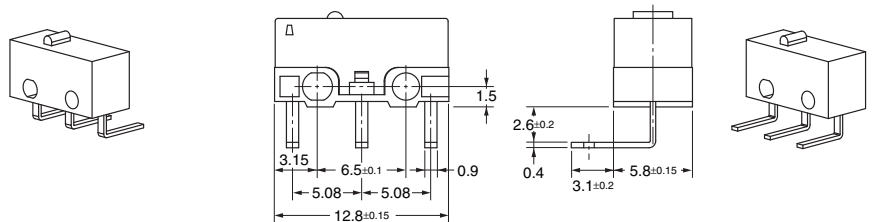

### ●Solder terminals

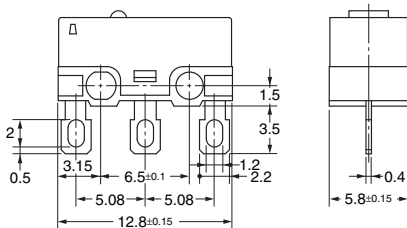

### ●Compact solder terminals

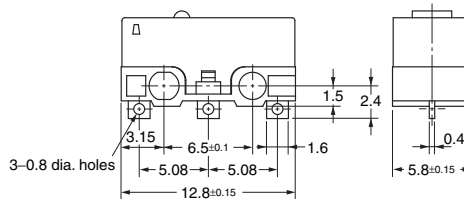

## Mounting Holes (Unit: mm)

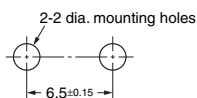

## Dimensions (Unit: mm) / Operating Characteristics

The following illustrations and drawings are for D2F models with PCB terminals (straight). Self-clinching, solder, compact solder, and right-angled, left angled terminals are omitted from the following drawings. Refer to the **previous page** for these terminals.

When ordering, replace □ with the code for the terminal that you need. See the "List of Models" for available combinations of models.

### ● Pin Plunger Models

- D2F□
- D2F-01□
- D2F-F□
- D2F-01F□

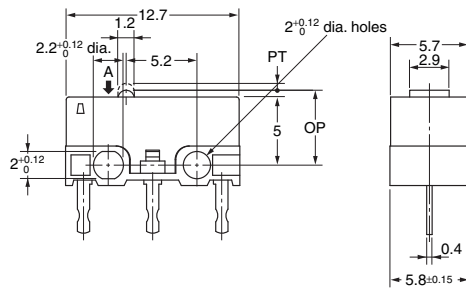

Operating Characteristics	Model	D2F-□	D2F-F□
		D2F-01□	D2F-01F□
Operating Force	OF Max.	1.47 N {150 gf}	0.74 N {75 gf}
Releasing Force	RF Min.	0.20 N {20 gf}	0.05 N {5 gf}
Pretravel	PT Max.	0.5 mm	0.5 mm
Overtravel	OT Min.	0.25 mm	0.25 mm
Movement Differential	MD Max.	0.12 mm	0.12 mm
Operating Position	OP	5.5±0.3 mm	

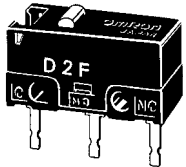

### ● Hinge Lever Models

- D2F-L□
- D2F-01L□
- D2F-FL□
- D2F-01FL□

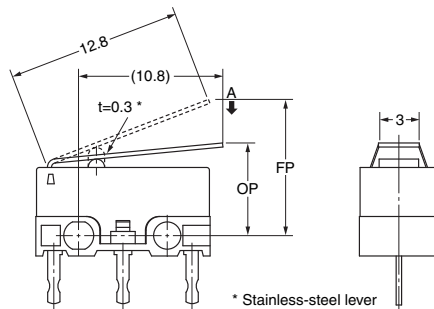

Operating Characteristics	Model	D2F-L□	D2F-FL□
		D2F-01L□	D2F-01FL□
Operating Force	OF Max.	0.78 N {80 gf}	0.25 N {25 gf}
Releasing Force	RF Min.	0.05 N {5 gf}	0.02 N {2 gf}
Overtravel	OT Min.	0.55 mm	0.55 mm
Movement Differential	MD Max.	0.5 mm	0.5 mm
Free Position	FP Max.	10 mm	
Operating Position	OP	6.8±1.5 mm	

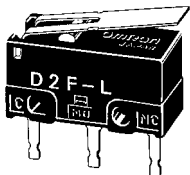

### ● Simulated Roller Lever Models (R1.3)

- D2F-L3□
- D2F-01L3□
- D2F-FL3□
- D2F-01FL3□

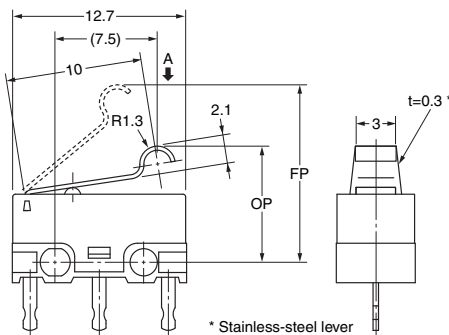

Operating Characteristics	Model	D2F-L3□	D2F-FL3□
		D2F-01L3□	D2F-01FL3□
Operating Force	OF Max.	0.78 N {80 gf}	0.39 N {40 gf}
Releasing Force	RF Min.	0.05 N {5 gf}	0.02 N {2 gf}
Overtravel	OT Min.	0.5 mm	0.5 mm
Movement Differential	MD Max.	0.45 mm	0.45 mm
Free Position	FP Max.	13 mm	
Operating Position	OP	8.5±1.2 mm	

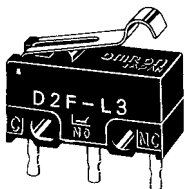

### ● Simulated Roller Lever Models (R2.5)

- D2F-L30□
- D2F-01L30□
- D2F-FL30□
- D2F-01FL30□

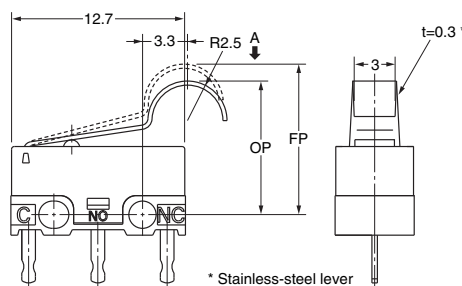

Operating Characteristics	Model	D2F-L30□	D2F-FL30□
		D2F-01L30□	D2F-01FL30□
Operating Force	OF Max.	0.54 N {55 gf}	0.3 N {31 gf}
Releasing Force	RF Min.	0.04 N {4 gf}	0.02 N {2 gf}
Overtravel	OT Min.	0.5 mm	0.5 mm
Movement Differential	MD Max.	0.5 mm	0.5 mm
Free Position	FP Max.	12.6 mm	
Operating Position	OP	9.5±1.0 mm	

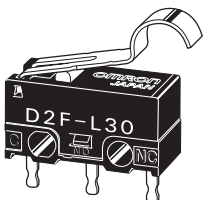

Note 1. Unless otherwise specified, a tolerance of ±0.4 mm applies to all dimensions.

Note 2. The operating characteristics are for operation in the A direction (↓).

## ●Hinge Roller Lever Models

- D2F-L2□
- D2F-01L2□
- D2F-FL2□
- D2F-01FL2□

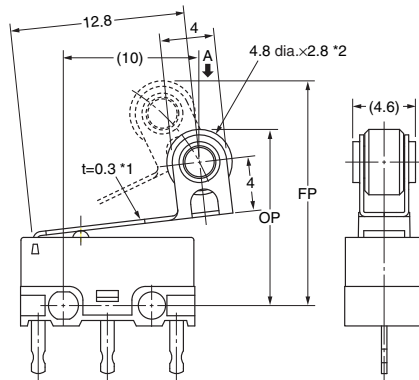
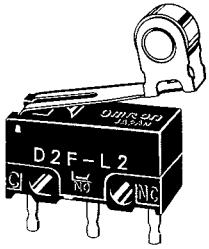

\*1. Stainless-steel lever  
\*2. Polyacetal resin roller

Operating Characteristics	Model	D2F-L2□	D2F-FL2□
		D2F-01L2□	D2F-01FL2□
Operating Force	OF Max.	0.78 N {80 gf}	0.39 N {40 gf}
Releasing Force	RF Min.	0.05 N {5 gf}	0.02 N {2 gf}
Overtravel	OT Min.	0.55 mm	0.55 mm
	MD Max.	0.5 mm	0.5 mm
Free Position	FP Max.	16.5 mm	
Operating Position	OP	13±2 mm	

Note 1. Unless otherwise specified, a tolerance of ±0.4 mm applies to all dimensions.  
Note 2. The operating characteristics are for operation in the A direction (↓).

## Precautions

★Please refer to "Basic Switches Common Precautions" for correct use.

### Cautions

#### ●Soldering

- Terminal connection  
When soldering, make sure that the temperature of the soldering iron tip is not higher than 300°C, and complete the soldering within 3 seconds. Do not apply any external force for 1 minute after soldering. Soldering at an excessively high temperature or soldering for more than 3 seconds may deteriorate the characteristics of the Switch.
- Connecting to PCB terminal Boards  
When using automatic soldering baths, we recommend soldering at 260°C ±5°C within 5 seconds. Make sure that the liquid surface of the solder does not flow over the edge of the board.  
When soldering terminals manually, perform soldering within 3 seconds at iron tip temperature not higher than 350°C. Do not apply any external force for at least 1 minute after soldering. When applying solder, keep the solder away from the case of the Switch and do not allow solder or flux to flow into the case.

### Correct Use

#### ●Mounting

Use M2 mounting screws with plane washers or spring washers to securely mount the Switch. Tighten the screws to a torque of 0.08 to 0.1 N·m {0.8 to 1 kgf·cm}.

#### ●Using Micro Loads

Using a model for ordinary loads to open or close the contact of a micro load circuit may result in faulty contact. Use models that operate in the following range. However, even when using micro load models within the following operating range, if inrush current occurs when the contact is opened or closed, it may increase the contact wear and so decrease durability. Therefore, insert a contact protection circuit where necessary. The minimum applicable load is the N-level reference value. This value indicates the malfunction reference level for the reliability level of 60% ( $\lambda_{60}$ ).

(JIS C5003)

The equation,  $\lambda_{60}=0.5 \times 10^{-6} / \text{operation}$ , indicates that the estimated malfunction rate is less than  $\frac{1}{2,000,000}$  operations with a reliability level of 60%.

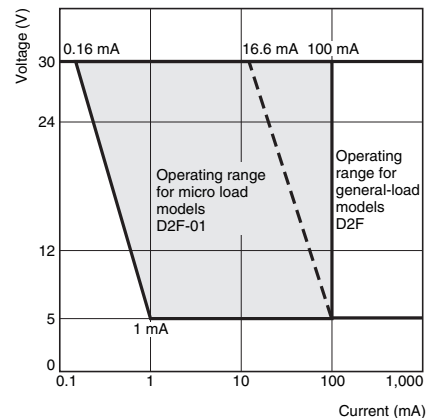

- Application examples provided in this document are for reference only. In actual applications, confirm equipment functions and safety before using the product.
- Consult your OMRON representative before using the product under conditions which are not described in the manual or applying the product to nuclear control systems, railroad systems, aviation systems, vehicles, combustion systems, medical equipment, amusement machines, safety equipment, and other systems or equipment that may have a serious influence on lives and property if used improperly. Make sure that the ratings and performance characteristics of the product provide a margin of safety for the system or equipment, and be sure to provide the system or equipment with double safety mechanisms.

**Note: Do not use this document to operate the Unit.**

---

**OMRON Corporation**

**ELECTRONIC AND MECHANICAL COMPONENTS COMPANY**

**Contact: [www.omron.com/ecb](http://www.omron.com/ecb)**

**Cat. No. B036-E1-09**  
0812(0207)(O)