



HESTORE.HU

elektronikai alkatrész áruház

EN: This Datasheet is presented by the manufacturer.

Please visit our website for pricing and availability at www.hestore.hu.

NO MERCURY ADDED	
Description	: Mercury & Cadmium Free Lithium / Iron Disulfide battery AAA Size
Chemical System	: Lithium / Iron Disulfide (Li/FeS ₂)
Nominal Voltage	: 1.5 Volts
Nominal Dimensions	: Ø10.5 mm x 44.5 mm
Terminals	: Protruded positive(+) and flat negative(-) contacts
Jacket	: Foil jacket
Applications	: All electronic devices, e.g. Digital cameras, photoflash, toys, portable lighting, digital audio
Shelf life	: 10 years at 21°C (80% rated capacity)
Average Weight	: 7.5g

Cross References:

GP	JIS	IEC	Energizer	Duracell
24LF	FR03	FR03	L92	LF2400

Model No.: **GP24LF**

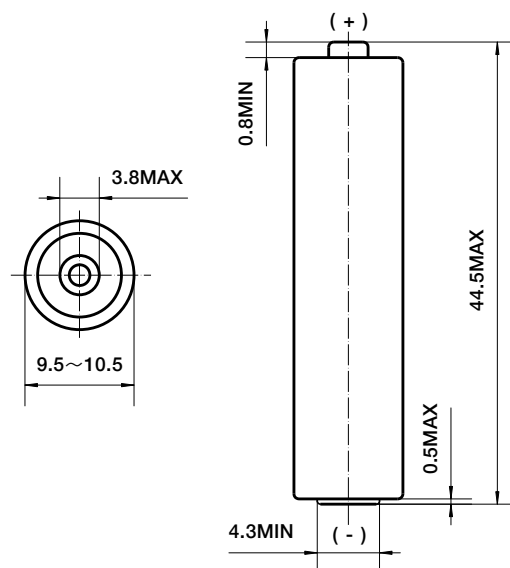

Unit : mm

Constant Current Performance (21°C)

Typical Characteristics to 1.0 V

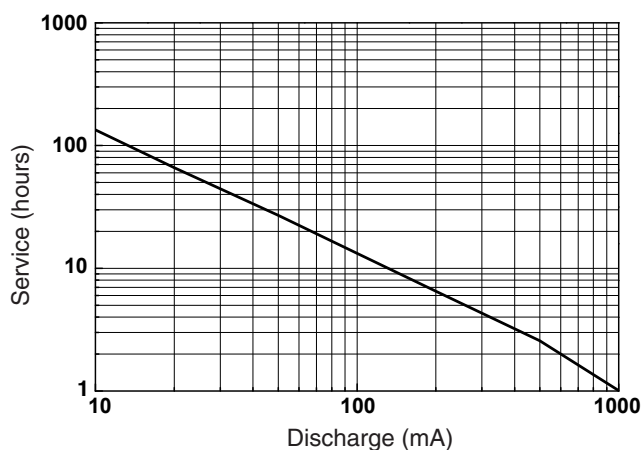

Constant Power Performance (21°C)

Typical Characteristics to 1.0 V

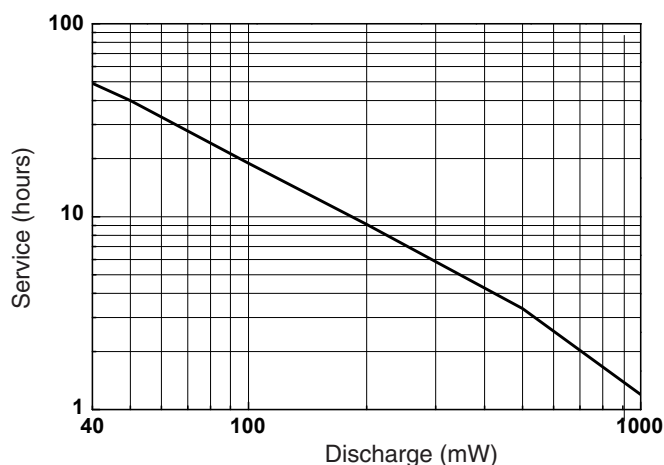

The information (subject to change without prior notice) contained in this document is for reference only and should not be used as a basis for product guarantee or warranty. For applications other than those described here, please consult your nearest GP Sales and Marketing Office or Distributors.

www.gpbatteries.com

Manufacturer reserves the right to alter or amend the design, model and specification without prior notice.
Copyright© GPI International Ltd. - All rights reserved

Member
Gold Peak Group

High Drain Performance (21°C)

600 mA Continuous

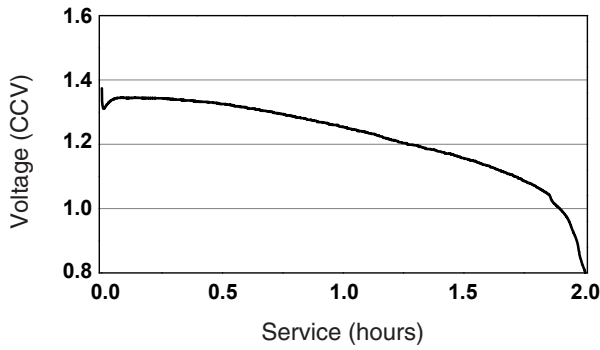

Low Drain Performance (21°C)

50 mA Continuous

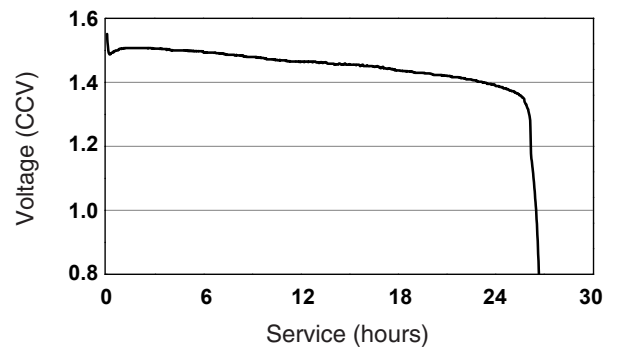

Application Test (23±2°C)

Digital Still Camera
1.2 W 2s/0.65 W 28s, 10T/hr

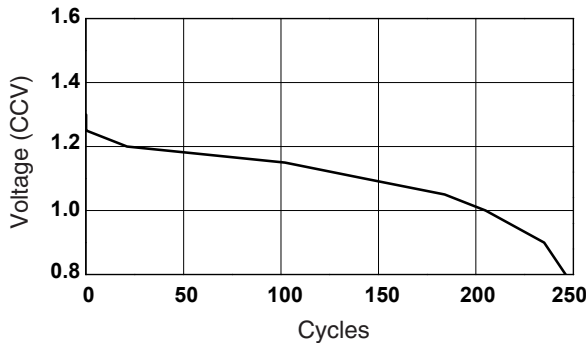

Application Test (23±2°C)

High Intensity Lighting
0.4 W 4m/15m, 8h/d

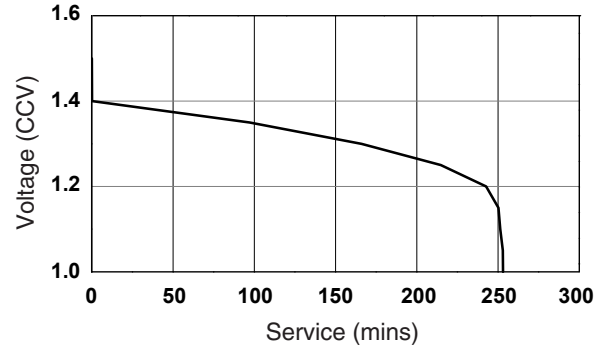

Application Test (23±2°C)

Photo Flash 600 mA 10s/m, 1h/d Light 5.1 ohm LIF

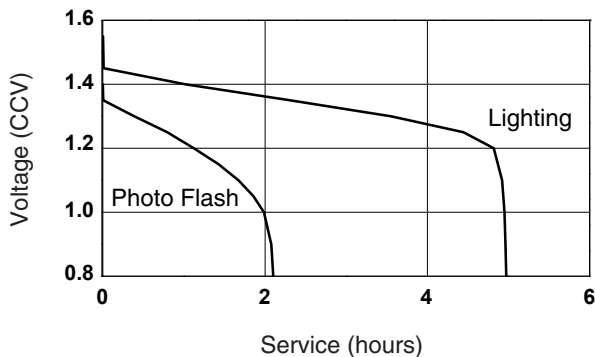

Application Test (23±2°C)

Electronic Game/Digital Audio 100 mA, 1h/d Remote 24 ohm 15s/m, 8h/d

