



HESTORE.HU

elektronikai alkatrész áruház

EN: This Datasheet is presented by the manufacturer.

Please visit our website for pricing and availability at www.hestore.hu.

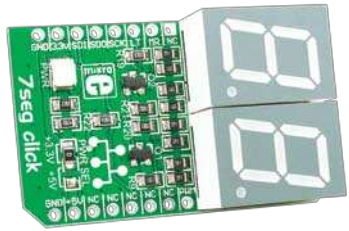

7seg click™

1. Introduction

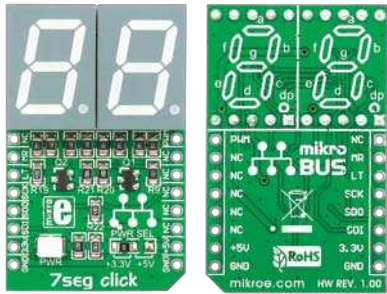

7seg Click™ is an accessory board in **mikroBUS™** form factor. It's a compact and easy solution for adding seven-segment display to your device. It features two **74HC595** 8-bit serial-in, parallel-out shift register modules as well as two seven-segment displays. 7seg Click™ communicates with target board via SPI interface. The board is designed to use 3.3V and 5V power supply. It has a LED diode (GREEN) that indicates the presence of power supply.

2. Soldering the headers

Before using your click board™, make sure to solder 1x8 male headers to both left and right side of the board. Two 1x8 male headers are included with the board in the package.

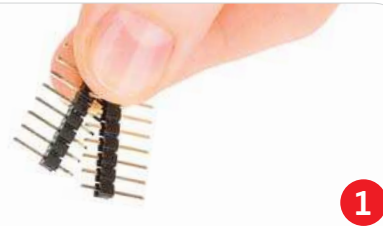

Turn the board upside down so that bottom side is facing you upwards. Place shorter parts of the header pins in both soldering pad locations.



Turn the board upward again. Make sure to align the headers so that they are perpendicular to the board, then solder the pins carefully.

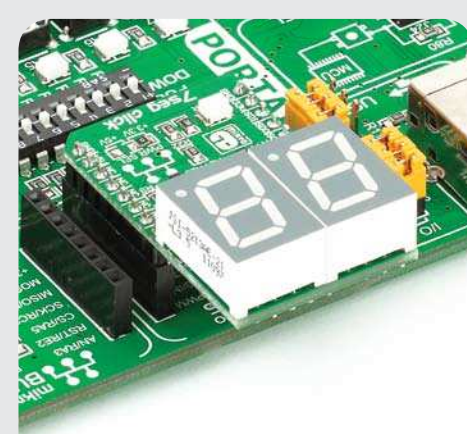

4. Essential features

7seg Click™ with its **74HC595** IC's gives additional seven-segment displays to your design. The **74HC595** IC contains an 8-bit serial-in, parallel/serial-out shift register as well as 8-bit storage register. The storage registers has parallel 3-state outputs. Separate clocks are provided for both the shift and storage register. Shift register has a direct overriding clear input.

3. Plugging the board in

Once you have soldered the headers your board is ready to be placed into desired mikroBUS™ socket. Make sure to align the cut in the lower-right part of the board with the markings on the silkscreen at the mikroBUS™ socket. If all of the pins are aligned correctly, push the board all the way into the socket.

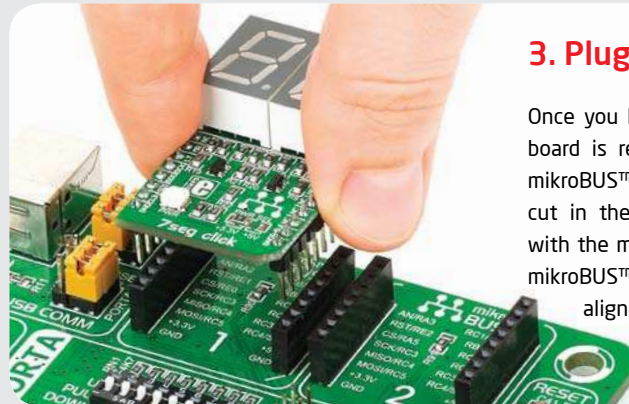

click™
BOARD
www.mikroe.com

7seg click Manual
ver. 1.00



0 100000 021071

5. 7seg Click™ Board Schematic

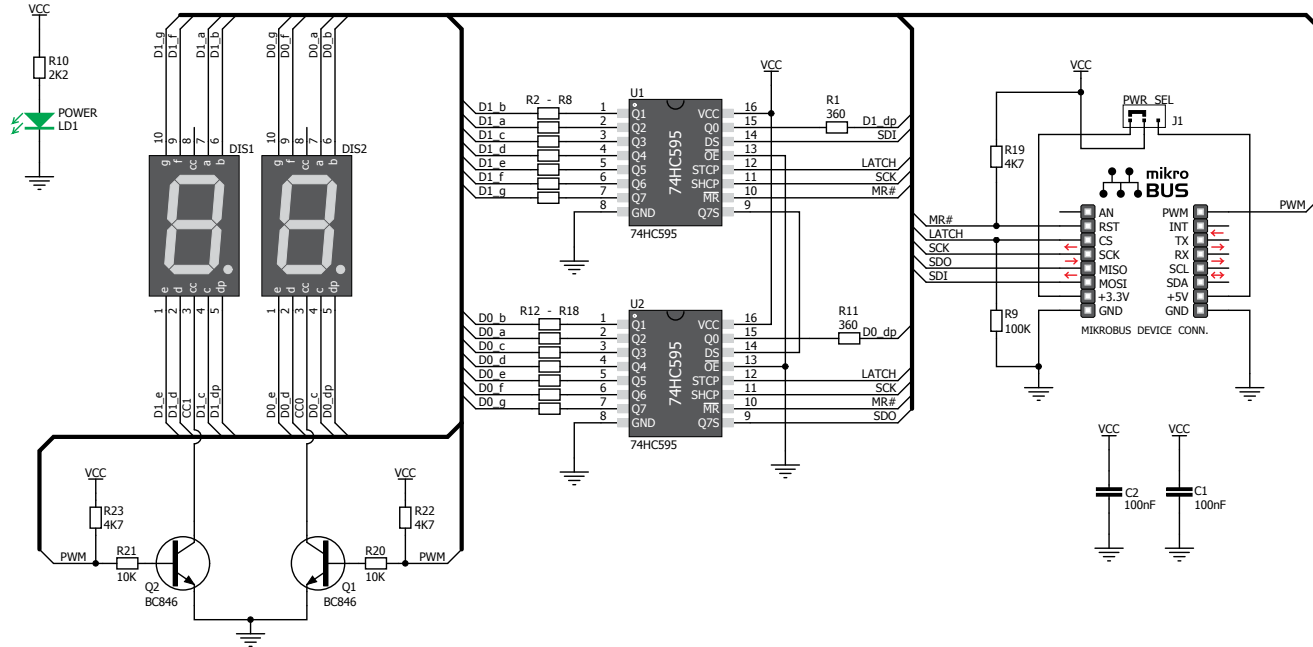

6. SMD Jumper

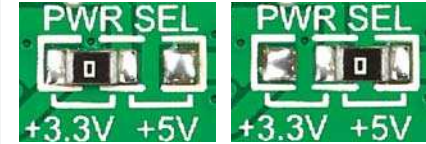

There is one zero-ohm SMD jumper **J1** which is used to select whether 3.3V or 5V power supply is used. Jumper **J1** is soldered in 3.3V position by default.

7. Code Examples

Once you have done all the necessary preparations, it's time to get your click board up and running. We have provided the examples for mikroC, mikroBasic and mikroPascal compilers on our **Libstock** website. Just download them and you are ready to start.



8. Support

MikroElektronika offers **Free Tech Support** (www.mikroe.com/esupport) until the end of product lifetime, so if something goes wrong, we are ready and willing to help!