



HESTORE.HU

elektronikai alkatrész áruház

EN: This Datasheet is presented by the manufacturer.

Please visit our website for pricing and availability at www.hestore.hu.

D3V

Miniature Basic Switch

Reliable Basic Switch with External Lever

- Available by 21 A, 16 A, 11 A, 6 A and 0.1 A models, all with self-cleaning contacts.
- Available with internally or externally fitted levers.

RoHS Compliant

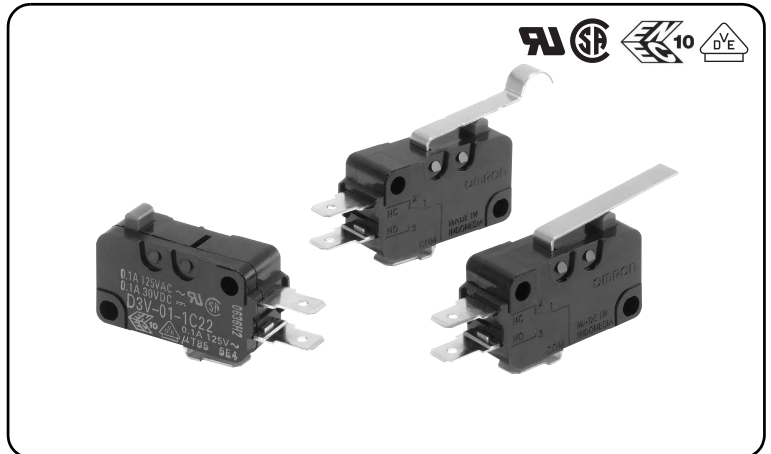

D
3
V

Model Number Legend

D3V-1 2 3 4 - 5 6 7 - 8 - 9

1. Ratings

- 21 : 20 (4) A at 250 VAC
- 16 : 16 (3) A at 250 VAC
- 11 : 11 (3) A at 250 VAC
- 6 : 16 (2) A at 250 VAC
- 01 : 0.1 A at 125 VAC

2. Contact Gap

- None: 1 mm (F gap)
- G : 0.5 mm (G gap)

3. Actuator

- None: Pin plunger
- 1 : Short hinge lever
- 2 : Hinge lever
- 3 : Long hinge lever
- 4 : Simulated roller lever
- 5 : Short hinge roller lever
- 6 : Hinge roller lever

4. Hinge Position

- None: Internal/Far from plunger

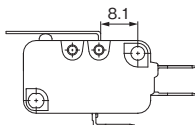

- K : External/Near plunger

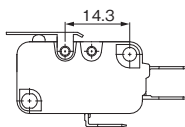

5. Contact Form

- 1 : SPDT
- 2 : SPST-NC
- 3 : SPST-NO

6. Terminals

- A : Solder terminals
- C2 : Quick-connect terminals (#187)
- C : Quick-connect terminals (#250)

7. Maximum Operating Force

- 5 : 1.96 N {200 gf}
- 4A : 1.23 N {125 gf}
- 4 : 0.98 N {100 gf}
- 3 : 0.49 N {50 gf}
- 2 : 0.25 N {25 gf}

Note. These values are for the pin plunger models.

8. Mounting Hole Size

- None: 3.1 mm
- K : 2.9 mm







9. Special Code

- None: Standard
- H : High temperature (125°C) (See note)
- E : Special rating: 21 (8) A

Note. Consult your OMRON sales representative for high temperature models.

List of Models







●21 A (OF: 1.23 N {125 gf})

| Ratings | Contact gap | Actuators | Contact form | Terminals Maximum operating force (OF) | Quick-connect terminals (#250) (C) |
|---|-------------------|---|----------------------|--|--|
| 21 A | 0.5 mm (G gap) | Pin plunger  | SPDT | 1.23 N {125 gf} | D3V-21G-1C4A |
| | | | SPDT-NC | | - |
| | | | SPDT-NO | | - |
| | | Short hinge lever  | SPDT | 1.23 N {125 gf} | D3V-21G1-1C4A |
| | | | SPDT-NC | | - |
| | | | SPDT-NO | | - |
| | | Hinge lever  | SPDT | 0.78 N {80 gf} | D3V-21G2-1C4A |
| | | | SPDT-NC | | - |
| | | | SPDT-NO | | - |
| | | Long hinge lever  | SPDT | 0.44 N {45 gf} | D3V-21G3-1C4A |
| | | | SPDT-NC | | - |
| | | | SPDT-NO | | - |
| | | Simulated roller lever  | SPDT | 0.83 N {85 gf} | D3V-21G4-1C4A |
| | | | SPDT-NC | | - |
| | | | SPDT-NO | | - |
| | | Short hinge roller lever  | SPDT | 1.42 N {145 gf} | D3V-21G5-1C4A |
| | | | SPDT-NC | | - |
| | | | SPDT-NO | | - |
| Hinge roller lever  | SPDT | 0.79 N {80 gf} | D3V-21G6-1C4A | | |
| | SPDT-NC | | - | | |
| | SPDT-NO | | - | | |

Note. If you need mounting hole 2.9 mm, add "-K" at last of model.

Consult your OMRON sales representative when you can't find a model on this List of Models.







●16 A (OF: 1.96 N {200 gf})

| Ratings | Contact gap | Actuators | Contact form | Terminals Maximum operating force (OF) | Solder terminals (A) | Quick-connect terminals (#187) (C2) | Quick-connect terminals (#250) (C) |
|---------|-----------------|---|--------------|--|-------------------------|---|--|
| 16 A | 1 mm (F gap) | Pin plunger  | SPDT | 1.96 N {200 gf} | D3V-16-1A5 | D3V-16-1C25 | D3V-16-1C5 |
| | | | SPDT-NC | | D3V-16-2A5 | D3V-16-2C25 | D3V-16-2C5 |
| | | | SPDT-NO | | D3V-16-3A5 | D3V-16-3C25 | D3V-16-3C5 |
| | | Short hinge lever  | SPDT | 1.96 N {200 gf} | D3V-161-1A5 | D3V-161-1C25 | D3V-161-1C5 |
| | | | SPDT-NC | | D3V-161-2A5 | D3V-161-2C25 | D3V-161-2C5 |
| | | | SPDT-NO | | D3V-161-3A5 | D3V-161-3C25 | D3V-161-3C5 |
| | | Hinge lever  | SPDT | 1.23 N {125 gf} | D3V-162-1A5 | D3V-162-1C25 | D3V-162-1C5 |
| | | | SPDT-NC | | D3V-162-2A5 | D3V-162-2C25 | D3V-162-2C5 |
| | | | SPDT-NO | | D3V-162-3A5 | D3V-162-3C25 | D3V-162-3C5 |
| | | Long hinge lever  | SPDT | 0.69 N {70 gf} | D3V-163-1A5 | D3V-163-1C25 | D3V-163-1C5 |
| | | | SPDT-NC | | D3V-163-2A5 | D3V-163-2C25 | D3V-163-2C5 |
| | | | SPDT-NO | | D3V-163-3A5 | D3V-163-3C25 | D3V-163-3C5 |
| | | Simulated roller lever  | SPDT | 1.23 N {125 gf} | D3V-164-1A5 | D3V-164-1C25 | D3V-164-1C5 |
| | | | SPDT-NC | | D3V-164-2A5 | D3V-164-2C25 | D3V-164-2C5 |
| | | | SPDT-NO | | D3V-164-3A5 | D3V-164-3C25 | D3V-164-3C5 |
| | | Short hinge roller lever  | SPDT | 2.35 N {240 gf} | D3V-165-1A5 | D3V-165-1C25 | D3V-165-1C5 |
| | | | SPDT-NC | | D3V-165-2A5 | D3V-165-2C25 | D3V-165-2C5 |
| | | | SPDT-NO | | D3V-165-3A5 | D3V-165-3C25 | D3V-165-3C5 |
| | | Hinge roller lever  | SPDT | 1.23 N {125 gf} | D3V-166-1A5 | D3V-166-1C25 | D3V-166-1C5 |
| | | | SPDT-NC | | D3V-166-2A5 | D3V-166-2C25 | D3V-166-2C5 |
| | | | SPDT-NO | | D3V-166-3A5 | D3V-166-3C25 | D3V-166-3C5 |

Note. If you need mounting hole 2.9 mm, add "-K" at last of model.

Consult your OMRON sales representative when you can't find a model on this List of Models.







●11 A (OF: 1.96 N {200 gf})

| Ratings | Contact gap | Actuators | Contact form | Terminals Maximum operating force (OF) | Solder terminals (A) | Quick-connect terminals (#187) (C2) | Quick-connect terminals (#250) (C) |
|---------|-----------------|---|--------------|--|-------------------------|---|--|
| 11 A | 1 mm (F gap) | Pin plunger  | SPDT | 1.96N {200 gf} | D3V-11-1A5 | D3V-11-1C25 | D3V-11-1C5 |
| | | | SPDT-NC | | - | - | - |
| | | | SPDT-NO | | - | - | - |
| | | Short hinge lever  | SPDT | 1.96N {200 gf} | D3V-111-1A5 | D3V-111-1C25 | D3V-111-1C5 |
| | | | SPDT-NC | | - | - | - |
| | | | SPDT-NO | | - | - | - |
| | | Hinge lever  | SPDT | 1.23N {125 gf} | D3V-112-1A5 | D3V-112-1C25 | D3V-112-1C5 |
| | | | SPDT-NC | | - | - | - |
| | | | SPDT-NO | | - | - | - |
| | | Long hinge lever  | SPDT | 0.69N {70 gf} | D3V-113-1A5 | D3V-113-1C25 | D3V-113-1C5 |
| | | | SPDT-NC | | - | - | - |
| | | | SPDT-NO | | - | - | - |
| | | Simulated roller lever  | SPDT | 1.23N {125 gf} | D3V-114-1A5 | D3V-114-1C25 | D3V-114-1C5 |
| | | | SPDT-NC | | - | - | - |
| | | | SPDT-NO | | - | - | - |
| | | Short hinge roller lever  | SPDT | 2.35N {240 gf} | D3V-115-1A5 | D3V-115-1C25 | D3V-115-1C5 |
| | | | SPDT-NC | | - | - | - |
| | | | SPDT-NO | | - | - | - |
| | | Hinge roller lever  | SPDT | 1.23N {125 gf} | D3V-116-1A5 | D3V-116-1C25 | D3V-116-1C5 |
| | | | SPDT-NC | | - | - | - |
| | | | SPDT-NO | | - | - | - |

Note. If you need mounting hole 2.9 mm, add "-K" at last of model.

Consult your OMRON sales representative when you can't find a model on this List of Models.







●11 A (OF: 0.98 N {100 gf})

| Ratings | Contact gap | Actuators | Contact form | Terminals Maximum operating force (OF) | Solder terminals (A) | Quick-connect terminals (#187) (C2) | Quick-connect terminals (#250) (C) |
|---------|-----------------|---|--------------|--|-------------------------|---|--|
| 11 A | 1 mm (F gap) | Pin plunger  | SPDT | 0.98N {100 gf} | D3V-11-1A4 | D3V-11-1C24 | D3V-11-1C4 |
| | | | SPDT-NC | | - | - | - |
| | | | SPDT-NO | | - | - | - |
| | | Short hinge lever  | SPDT | 0.98N {100 gf} | D3V-111-1A4 | D3V-111-1C24 | D3V-111-1C4 |
| | | | SPDT-NC | | - | - | - |
| | | | SPDT-NO | | - | - | - |
| | | Hinge lever  | SPDT | 0.59N {60 gf} | D3V-112-1A4 | D3V-112-1C24 | D3V-112-1C4 |
| | | | SPDT-NC | | - | - | - |
| | | | SPDT-NO | | - | - | - |
| | | Long hinge lever  | SPDT | 0.34N {35 gf} | D3V-113-1A4 | D3V-113-1C24 | D3V-113-1C4 |
| | | | SPDT-NC | | - | - | - |
| | | | SPDT-NO | | - | - | - |
| | | Simulated roller lever  | SPDT | 0.59N {60 gf} | D3V-114-1A4 | D3V-114-1C24 | D3V-114-1C4 |
| | | | SPDT-NC | | - | - | - |
| | | | SPDT-NO | | - | - | - |
| | | Short hinge roller lever  | SPDT | 1.18N {120 gf} | D3V-115-1A4 | D3V-115-1C24 | D3V-115-1C4 |
| | | | SPDT-NC | | - | - | - |
| | | | SPDT-NO | | - | - | - |
| | | Hinge roller lever  | SPDT | 0.59N {60 gf} | D3V-116-1A4 | D3V-116-1C24 | D3V-116-1C4 |
| | | | SPDT-NC | | - | - | - |
| | | | SPDT-NO | | - | - | - |







Note. If you need mounting hole 2.9 mm, add "-K" at last of model.

Consult your OMRON sales representative when you can't find a model on this List of Models.

●6 A (OF: 0.98 N {100 gf})

| Ratings | Contact gap | Actuators | Contact form | Terminals Maximum operating force (OF) | Solder terminals (A) | Quick-connect terminals (#187) (C2) | Quick-connect terminals (#250) (C) |
|---------|-----------------|---|--------------|--|-------------------------|---|--|
| 6 A | 1 mm (F gap) | Pin plunger  | SPDT | 0.98 N {100 gf} | D3V-6-1A4 | D3V-6-1C24 | D3V-6-1C4 |
| | | | SPDT-NC | | - | - | - |
| | | | SPDT-NO | | - | - | - |
| | | Short hinge lever  | SPDT | 0.98 N {100 gf} | D3V-61-1A4 | D3V-61-1C24 | D3V-61-1C4 |
| | | | SPDT-NC | | - | - | - |
| | | | SPDT-NO | | - | - | - |
| | | Hinge lever  | SPDT | 0.59 N {60 gf} | D3V-62-1A4 | D3V-62-1C24 | D3V-62-1C4 |
| | | | SPDT-NC | | - | - | - |
| | | | SPDT-NO | | - | - | - |
| | | Long hinge lever  | SPDT | 0.34 N {35 gf} | D3V-63-1A4 | D3V-63-1C24 | D3V-63-1C4 |
| | | | SPDT-NC | | - | - | - |
| | | | SPDT-NO | | - | - | - |
| | | Simulated roller lever  | SPDT | 0.59 N {60 gf} | D3V-64-1A4 | D3V-64-1C24 | D3V-64-1C4 |
| | | | SPDT-NC | | - | - | - |
| | | | SPDT-NO | | - | - | - |
| | | Short hinge roller lever  | SPDT | 1.18 N {120 gf} | D3V-65-1A4 | D3V-65-1C24 | D3V-65-1C4 |
| | | | SPDT-NC | | - | - | - |
| | | | SPDT-NO | | - | - | - |
| | | Hinge roller lever  | SPDT | 0.59 N {60 gf} | D3V-66-1A4 | D3V-66-1C24 | D3V-66-1C4 |
| | | | SPDT-NC | | - | - | - |
| | | | SPDT-NO | | - | - | - |







●6 A (OF: 0.49 N {50 gf})

| Ratings | Contact gap | Actuators | Contact form | Terminals Maximum operating force (OF) | Solder terminals (A) | Quick-connect terminals (#187) (C2) | Quick-connect terminals (#250) (C) |
|---------|-----------------|---|--------------|--|-------------------------|---|--|
| 6 A | 0.5 mm Ggap) | Pin plunger  | SPDT | 0.49 N {50 gf} | D3V-6G-1A3 | D3V-6G-1C23 | D3V-6G-1C3 |
| | | | SPDT-NC | | - | - | - |
| | | | SPDT-NO | | - | - | - |
| | | Short hinge lever  | SPDT | 0.49 N {50 gf} | D3V-6G1-1A3 | D3V-6G1-1C23 | D3V-6G1-1C3 |
| | | | SPDT-NC | | - | - | - |
| | | | SPDT-NO | | - | - | - |
| | | Hinge lever  | SPDT | 0.59 N {60 gf} | D3V-6G2-1A3 | D3V-6G2-1C23 | D3V-6G2-1C3 |
| | | | SPDT-NC | | - | - | - |
| | | | SPDT-NO | | - | - | - |
| | | Long hinge lever  | SPDT | 0.20 N {20 gf} | D3V-6G3-1A3 | D3V-6G3-1C23 | D3V-6G3-1C3 |
| | | | SPDT-NC | | - | - | - |
| | | | SPDT-NO | | - | - | - |
| | | Simulated roller lever  | SPDT | 0.29 N {30 gf} | D3V-6G4-1A3 | D3V-6G4-1C23 | D3V-6G4-1C3 |
| | | | SPDT-NC | | - | - | - |
| | | | SPDT-NO | | - | - | - |
| | | Short hinge roller lever  | SPDT | 0.59 N {60 gf} | D3V-6G5-1A3 | D3V-6G5-1C23 | D3V-6G5-1C3 |
| | | | SPDT-NC | | - | - | - |
| | | | SPDT-NO | | - | - | - |
| | | Hinge roller lever  | SPDT | 0.29 N {30 gf} | D3V-6G6-1A3 | D3V-6G6-1C23 | D3V-6G6-1C3 |
| | | | SPDT-NC | | - | - | - |
| | | | SPDT-NO | | - | - | - |

Note. If you need mounting hole 2.9 mm, add "-K" at last of model.

Consult your OMRON sales representative when you can't find a model on this List of Models.

●0.1 A (OF: 0.49 N {50 gf})

| Ratings | Contact gap | Actuators | Contact form | Terminals Maximum operating force (OF) | Solder terminals (A) | Quick-connect terminals (#187) (C2) | Quick-connect terminals (#250) (C) |
|---------|-----------------|---|--------------|--|-------------------------|---|--|
| 0.1 A | 1 mm (F gap) |  Pin plunger | SPDT | 0.49 N {50 gf} | D3V-01-1A3 | D3V-01-1C23 | D3V-01-1C3 |
| | | | SPDT-NC | | D3V-01-2A3 | D3V-01-2C23 | D3V-01-2C3 |
| | | | SPDT-NO | | D3V-01-3A3 | D3V-01-3C23 | D3V-01-3C3 |
| | |  Short hinge lever | SPDT | 0.49 N {50 gf} | D3V-011-1A3 | D3V-011-1C23 | D3V-011-1C3 |
| | | | SPDT-NC | | D3V-011-2A3 | D3V-011-2C23 | D3V-011-2C3 |
| | | | SPDT-NO | | D3V-011-3A3 | D3V-011-3C23 | D3V-011-3C3 |
| | |  Hinge lever | SPDT | 0.59 N {60 gf} | D3V-012-1A3 | D3V-012-1C23 | D3V-012-1C3 |
| | | | SPDT-NC | | D3V-012-2A3 | D3V-012-2C23 | D3V-012-2C3 |
| | | | SPDT-NO | | D3V-012-3A3 | D3V-012-3C23 | D3V-012-3C3 |
| | |  Long hinge lever | SPDT | 0.20 N {20 gf} | D3V-013-1A3 | D3V-013-1C23 | D3V-013-1C3 |
| | | | SPDT-NC | | D3V-013-2A3 | D3V-013-2C23 | D3V-013-2C3 |
| | | | SPDT-NO | | D3V-013-3A3 | D3V-013-3C23 | D3V-013-3C3 |
| | |  Simulated roller lever | SPDT | 0.29 N {30 gf} | D3V-014-1A3 | D3V-014-1C23 | D3V-014-1C3 |
| | | | SPDT-NC | | D3V-014-2A3 | D3V-014-2C23 | D3V-014-2C3 |
| | | | SPDT-NO | | D3V-014-3A3 | D3V-014-3C23 | D3V-014-3C3 |
| | |  Short hinge roller lever | SPDT | 0.59 N {60 gf} | D3V-015-1A3 | D3V-015-1C23 | D3V-015-1C3 |
| | | | SPDT-NC | | D3V-015-2A3 | D3V-015-2C23 | D3V-015-2C3 |
| | | | SPDT-NO | | D3V-015-3A3 | D3V-015-3C23 | D3V-015-3C3 |
| | |  Hinge roller lever | SPDT | 0.29 N {30 gf} | D3V-016-1A3 | D3V-016-1C23 | D3V-016-1C3 |
| | | | SPDT-NC | | D3V-016-2A3 | D3V-016-2C23 | D3V-016-2C3 |
| | | | SPDT-NO | | D3V-016-3A3 | D3V-016-3C23 | D3V-016-3C3 |

Note. If you need mounting hole 2.9 mm, add "-K" at last of model.

Consult your OMRON sales representative when you can't find a model on this List of Models.

Contact Form

●SPDT

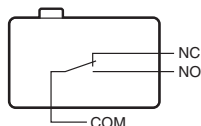

●SPST-NC

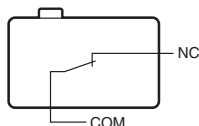

●SPST-NO

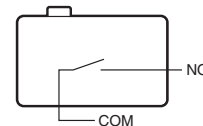

Contact Specifications

| Item | Model | D3V-21 | D3V-16 | D3V-11 | D3V-6 | D3V-01 |
|------------------------------------|----------------------|-----------------|----------------------------------|-----------|-----------|---------------|
| Contact | Specification | Rivet | | | | Crossbar |
| | Material | Silver alloy | | | | Gold alloy |
| | Gap (standard value) | 0.5 mm | 1.0 mm (F gap) or 0.5 mm (G gap) | | | 1.0 mm |
| Inrush current | NC | 50 A max. | 40 A max. | 24 A max. | 15 A max. | --- |
| | NO | | | | | |
| Minimum applicable load (see note) | | 160 mA at 5 VDC | | | | 1 mA at 5 VDC |

Note. For more information on the minimum applicable load, refer to *Using Micro Loads* on page 11.

Ratings

| Model | Rated voltage | Item | Resistive load |
|--------|---------------|------|----------------|
| D3V-21 | 250 VAC | | 21 A |
| | 125 VDC | | 0.6 A |
| | 250 VDC | | 0.3 A |
| D3V-16 | 250 VAC | | 16 A |
| | 125 VDC | | 0.6 A |
| | 250 VDC | | 0.3 A |
| D3V-11 | 250 VAC | | 11 A |
| | 125 VDC | | 0.6 A |
| | 250 VDC | | 0.3 A |
| D3V-6 | 250 VAC | | 6 A |
| | 125 VDC | | 0.4 A |
| | 250 VDC | | 0.3 A |
| D3V-01 | 125 VAC | | 0.1 A |
| | 30 VDC | | 0.1 A |

Note 1. The above current values are the normal current values of models with a contact gap of 1 mm (gap F), which vary with the normal current values of models with a contact gap of 0.5 mm (gap G).

Note 2. The ratings values apply under the following test conditions:

Ambient temperature: 20±2°C

Ambient humidity: 65±5%

Operating frequency: 30 operations/min

Approved Safety Standards

Consult your OMRON sales representative for specific models with standard approvals.

UL1054 (File No. E41515)/CSA C22.2 No.55 (File No. LR21642)

| Rated voltage | Model | D3V-21G | D3V-16 | D3V-16G | D3V-11 | D3V-11G | D3V-6 | D3V-6G | D3V-01 |
|---------------|-------|---------|--------------|--------------|--------------|--------------|-------------|-------------|--------|
| 125 VAC | | --- | 16 A, 1/2 HP | 16 A, 1/2 HP | 11 A, 1/2 HP | 11 A, 1/2 HP | 6 A, 1/4 HP | 6 A, 1/4 HP | 0.1 A |
| 250 VAC | | 20.1 A | 16 A, 1/2 HP | 16 A, 1/2 HP | 11 A, 1/2 HP | 11 A, 1/2 HP | 6 A, 1/4 HP | 6 A, 1/4 HP | --- |
| 125 VDC | | --- | 0.6 A | 0.1 A | 0.6 A | 0.1 A | --- | --- | --- |
| 250 VDC | | --- | 0.3 A | --- | 0.3 A | --- | --- | --- | --- |

EN 61058-1: 1992+A1: 1993 (License No. 40024894)

| Rated voltage | Model | D3V-21G | D3V-16 | D3V-11 | D3V-6 | D3V-01 |
|---------------|-------|----------|----------|----------|---------|--------|
| 125 VAC | | --- | --- | --- | --- | 0.1 A |
| 250 VAC | | 20 (4) A | 16 (3) A | 11 (3) A | 6 (2) A | --- |

Testing conditions: 5E4 (50,000 operations), T85 (0 to 85°C) for D3V-21/D3V-01, T105 (0 to 105°C) for D3V-16/D3V-11/D3V-6

| Rated voltage | Model | D3V-21G |
|---------------|-------|----------|
| 250 VAC | | 21 (8) A |

Testing conditions: 10,000 operations, T85 (0 to 85°C)

Characteristics

| Item | Model | D3V-21 | D3V-16 | D3V-11 | D3V-6 | D3V-01 |
|---|------------|---|--|-------------------------|-------------------------|---|
| Permissible operating speed | | 0.1 mm to 1 m/s (pin plunger models) | | | | |
| Permissible operating frequency | | Mechanical: 600 operations/min max. Electrical: 30 operations/min max. | | | | |
| Insulation resistance | | 100 MΩ min. (at 500 VDC with insulation tester) | | | | |
| Contact resistance (initial values) | | 50 mΩ max. | 30 mΩ max. | | | 0.49N {50 gf}: 50 mΩ max. 0.25N {25 gf}: 100 mΩ max. |
| Dielectric strength (see note 2) | | 1,000 VAC, 50/60 Hz for 1 min between terminals of the same polarity | | | | |
| | | 2,000 VAC, 50/60 Hz for 1 min between current-carrying metal parts and ground, and between each terminal and non-current-carrying metal parts | | | | |
| Vibration resistance (see note 3) | | Malfunction: 10 to 55 Hz, 1.5-mm double amplitude | | | | |
| Shock resistance (see note 3) | | Destruction: 400 m/s ² {approx. 40 G} max. Malfunction: 100 m/s ² {approx. 10 G} max. | | | | |
| Durability (see note 4) | Mechanical | 10,000,000 operations min. | | | | |
| | Electrical | 50,000 operations min. | 100,000 operations min. | 200,000 operations min. | 500,000 operations min. | |
| Degree of protection | | IEC IP40 | | | | |
| Degree of protection against electric shock | | Class I | | | | |
| Proof tracking index (PTI) | | 250 | | | | |
| Ambient operating temperature | | -25 to +85°C (at ambient humidity of 60% max.) (with no icing or condensation) | -25 to +105°C (at ambient humidity of 60% max.) (with no icing or condensation) | | | -25 to +85°C (at ambient humidity of 60% max.) (with no icing or condensation) |
| Ambient operating humidity | | 85% max. (for +5 to +35°C) | | | | |
| Weight | | Approx. 6.2 g (pin plunger models) | | | | |

Note 1. The data given above are initial values.

Note 2. The dielectric strength values shown in the table are for models with a Separator.

Note 3. For the pin plunger models, the above values apply for use at both the free position and total travel position. For the lever models, they apply at the total travel position.

Note 4. For testing conditions, contact your OMRON sales representative.

Terminals/Apearances (Unit: mm)

| Solder Terminals (A) | Quick-connect Terminals (#187) (C2) | Quick-connect Terminals (#250) (C) |
|---|--|--|
| <p>t = 0.5 Three, solder terminals</p> | <p>t = 0.5 Three, quick-connect terminals (#187)</p> | <p>t = 0.8 Three, quick-connect terminals (#250)</p> |
| <p>Note: Indicates the length to the center of the 1.6-dia. holes</p> | <p>1.6-dia. terminal hole</p> | <p>1.65-dia. terminal hole</p> |

Note. The table below is for the SPDT contact specifications. Two terminals will be available for SPST-NO or SPST-NC contact specifications. For terminal positions, refer to Contact Form on page 5.

Mounting Holes (Unit: mm)

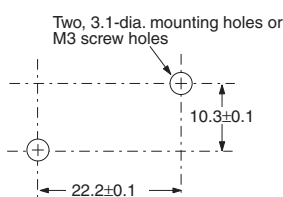

Dimensions (Unit: mm) and Operating Characteristics

The following illustrations and drawings are for quick-connect terminals (#187) (terminals C2). D3V models incorporate terminals A and C. These models are different from #187 models in terminal size only. Terminals A and C are omitted from the following drawings. Refer to "Terminals/Appearances" on page 7 for these terminals. The □ in the model number is for the terminal code.

●Pin Plunger Models

D3V-21G-1C4A

D3V-16-1□5

D3V-11-1□5

D3V-11-1□4

D3V-6-1□4

D3V-6G-1□3

D3V-01-1□3

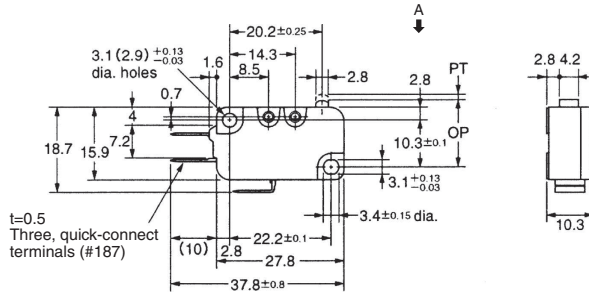
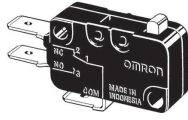

| Operating Characteristics | | | Model | D3V-21G-1C4A | D3V-16-1□5 D3V-11-1□5 | D3V-11-1□4 D3V-6-1□4 | D3V-6G-1□3 | D3V-01-1□3 |
|---------------------------|----|------|-------|-----------------|--------------------------|-------------------------|----------------|------------|
| Operating Force | OF | Max. | | 1.23 N {125 gf} | 1.96 N {200 gf} | 0.98 N {100 gf} | 0.49 N {50 gf} | |
| Releasing Force | RF | Min. | | 0.20 N {20 gf} | 0.49 N {50 gf} | 0.15 N {15 gf} | 0.05 N {5 gf} | |
| Pretravel | PT | Max. | | 1.2 mm | 1.2 mm | | 1.2 mm | 1.2 mm |
| Overtravel | OT | Min. | | 1.0 mm | 1.0 mm | | 1.0 mm | 1.0 mm |
| Movement Differential | MD | Max. | | 0.3 mm | 0.4 mm | | 0.3 mm | 0.4 mm |
| Operating Position | OP | | | 14.7±0.4 mm | | | | |

●Short Hinge Lever Models

D3V-21G1-1C4A

D3V-161-1□5

D3V-111-1□5

D3V-111-1□4

D3V-61-1□4

D3V-6G1-1□3

D3V-011-1□3

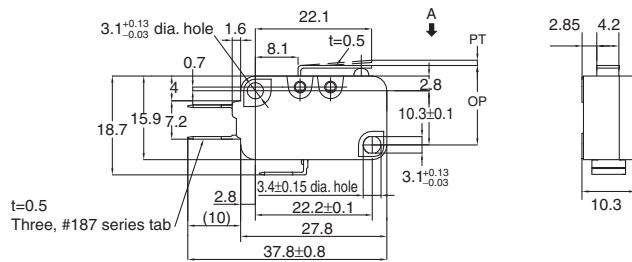
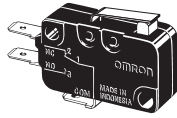

| Operating Characteristics | | | Model | D3V-21G1-1C4A | D3V-161-1□5 D3V-111-1□5 | D3V-111-1□4 D3V-61-1□4 | D3V-6G1-1□3 | D3V-011-1□3 |
|---------------------------|----|------|-------|-----------------|----------------------------|---------------------------|----------------|-------------|
| Operating Force | OF | Max. | | 1.23 N {125 gf} | 1.96 N {200 gf} | 0.98 N {100 gf} | 0.49 N {50 gf} | |
| Releasing Force | RF | Min. | | 0.20 N {20 gf} | 0.49 N {50 gf} | 0.15 N {15 gf} | 0.05 N {5 gf} | |
| Pretravel | PT | Max. | | 1.6 mm | 1.6 mm | | 1.6 mm | 1.6 mm |
| Overtravel | OT | Min. | | 0.8 mm | 0.8 mm | | 0.8 mm | 0.8 mm |
| Movement Differential | MD | Max. | | 0.5 mm | 0.6 mm | | 0.5 mm | 0.6 mm |
| Operating Position | OP | | | 15.2±0.5 mm | | | | |

●Hinge Lever Models

D3V-21G2-1C4A

D3V-162-1□5

D3V-112-1□5

D3V-112-1□4

D3V-62-1□4

D3V-6G2-1□3

D3V-012-1□3

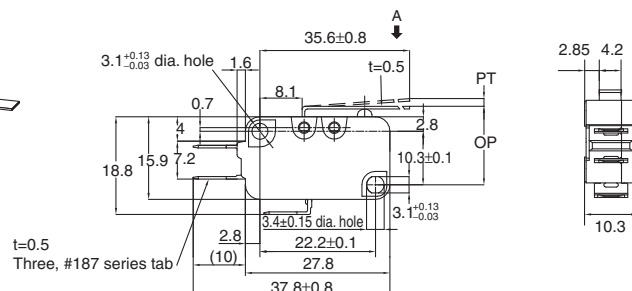

| Operating Characteristics | | | Model | D3V-21G2-1C4A | D3V-162-1□5 D3V-112-1□5 | D3V-112-1□4 D3V-62-1□4 | D3V-6G2-1□3 | D3V-012-1□3 |
|---------------------------|----|------|-------|----------------|----------------------------|---------------------------|----------------|-------------|
| Operating Force | OF | Max. | | 0.78 N {80 gf} | 1.23 N {125 gf} | 0.59 N {60 gf} | 0.29 N {30 gf} | |
| Releasing Force | RF | Min. | | 0.06 N {6 gf} | 0.14 N {14 gf} | 0.06 N {6 gf} | --- | |
| Pretravel | PT | Max. | | 4.0 mm | 4.0 mm | | 4.0 mm | 4.0 mm |
| Overtravel | OT | Min. | | 1.6 mm | 1.6 mm | | 1.6 mm | 1.6 mm |
| Movement Differential | MD | Max. | | 0.8 mm | 1.5 mm | | 0.8 mm | 1.5 mm |
| Operating Position | OP | | | 15.2±1.2 mm | | | | |

Note 1. Unless otherwise specified, a tolerance of ±0.4 mm applies to all dimensions.

Note 2. The operating characteristics are for operation in the A direction (↓).

●Long Hinge Lever Models

D3V-21G3-1C4A

D3V-163-1□5

D3V-113-1□5

D3V-113-1□4

D3V-63-1□4

D3V-6G3-1□3

D3V-013-1□3

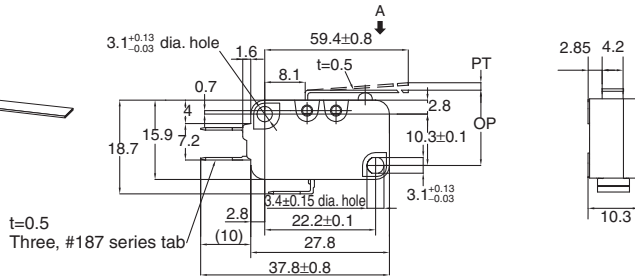
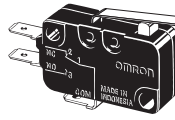

| Operating Characteristics | | Model | D3V-21G3-1C4A | D3V-163-1□5 D3V-113-1□5 | D3V-113-1□4 D3V-63-1□4 | D3V-6G3-1□3 | D3V-013-1□3 |
|---------------------------|----|--------------------|----------------|---|---------------------------|----------------|-------------|
| Operating Force | OF | Max. | 0.44 N {45 gf} | 0.69 N {70 gf} | 0.34 N {35 gf} | 0.20 N {20 gf} | |
| | RF | Min. | 0.03 N {3 gf} | 0.06 N {6 gf} | --- | --- | |
| Pretravel | PT | Max. | 9.0 mm | 9.0 mm | 9.0 mm | 9.0 mm | 9.0 mm |
| | OT | Min. | 2.0 mm | 2.0 mm | 2.0 mm | 3.2 mm | 3.2 mm |
| Movement Differential | MD | Max. | 2.0 mm | 2.8 mm | 2.0 mm | 2.0 mm | 2.8 mm |
| | | Operating Position | OP | 15.2 ^{+2.6} _{-3.2} mm | | 15.2±2.6 mm | |

●Simulated Roller Lever Models

D3V-21G4-1C4A

D3V-164-1□5

D3V-114-1□5

D3V-114-1□4

D3V-64-1□4

D3V-6G4-1□3

D3V-014-1□3

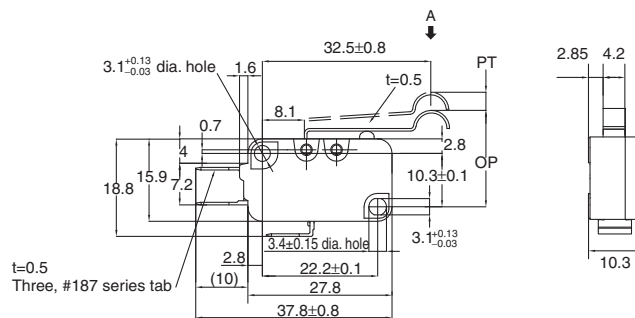
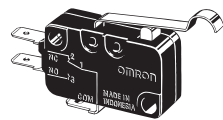

| Operating Characteristics | | Model | D3V-21G4-1C4A | D3V-164-1□5 D3V-114-1□5 | D3V-114-1□4 D3V-64-1□4 | D3V-6G4-1□3 | D3V-014-1□3 |
|---------------------------|----|--------------------|----------------|----------------------------|---------------------------|----------------|-------------|
| Operating Force | OF | Max. | 0.83 N {85 gf} | 1.23 N {125 gf} | 0.59 N {60 gf} | 0.29 N {30 gf} | |
| | RF | Min. | 0.07 N {7 gf} | 0.14 N {14 gf} | 0.06 N {6 gf} | --- | |
| Pretravel | PT | Max. | 4.0 mm | 4.0 mm | 4.0 mm | 4.0 mm | 4.0 mm |
| | OT | Min. | 1.6 mm | 1.6 mm | 1.6 mm | 1.6 mm | 1.6 mm |
| Movement Differential | MD | Max. | 1.4 mm | 1.5 mm | 1.5 mm | 1.4 mm | 1.5 mm |
| | | Operating Position | OP | 18.7±1.2 mm | | | |

●Short Hinge Roller Lever Models

D3V-21G5-1C4A

D3V-165-1□5

D3V-115-1□5

D3V-115-1□4

D3V-65-1□4

D3V-6G5-1□3

D3V-015-1□3

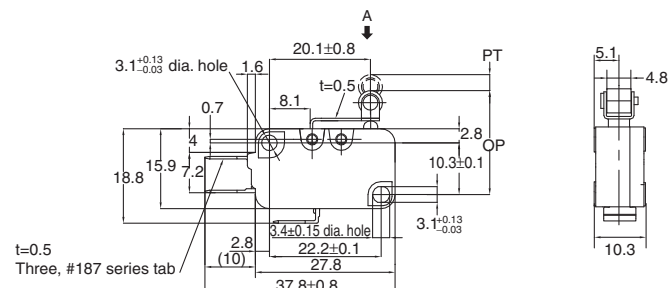
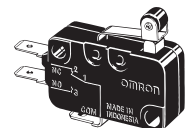

| Operating Characteristics | | Model | D3V-21G5-1C4A | D3V-165-1□5 D3V-115-1□5 | D3V-115-1□4 D3V-65-1□4 | D3V-6G5-1□3 | D3V-015-1□3 |
|---------------------------|----|--------------------|-----------------|----------------------------|---------------------------|----------------|-------------|
| Operating Force | OF | Max. | 1.42 N {145 gf} | 2.35 N {240 gf} | 1.18 N {120 gf} | 0.59 N {60 gf} | |
| | RF | Min. | 0.2 N {20 gf} | 0.49 N {50 gf} | 0.15 N {15 gf} | 0.06 N {6 gf} | |
| Pretravel | PT | Max. | 1.6 mm | 1.6 mm | 1.6 mm | 1.6 mm | 1.6 mm |
| | OT | Min. | 0.8 mm | 0.8 mm | 0.8 mm | 0.8 mm | 0.8 mm |
| Movement Differential | MD | Max. | 0.5 mm | 0.6 mm | 0.6 mm | 0.5 mm | 0.6 mm |
| | | Operating Position | OP | 20.7±0.6 mm | | | |

Note 1. Unless otherwise specified, a tolerance of ±0.4 mm applies to all dimensions.

Note 2. The operating characteristics are for operation in the A direction (↓).

●Hinge Roller Lever Models

D3V-21G6-1C4A

D3V-166-1□5

D3V-116-1□5

D3V-116-1□4

D3V-66-1□4

D3V-6G6-1□3

D3V-016-1□3

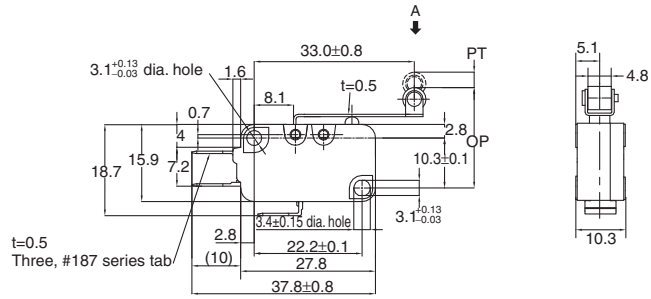
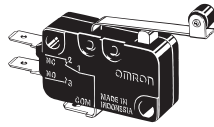

D
3
V

| Operating Characteristics | | | Model | D3V-21G6-1C4A | D3V-166-1□5 D3V-116-1□5 | D3V-116-1□4 D3V-66-1□4 | D3V-6G6-1□3 | D3V-016-1□3 |
|---------------------------|----|------|-------|----------------|----------------------------|---------------------------|----------------|-------------|
| Operating Force | OF | Max. | | 0.79 N {80 gf} | 1.23 N {125 gf} | 0.59 N {60 gf} | 0.29 N {30 gf} | |
| Releasing Force | RF | Min. | | 0.05 N {5 gf} | 0.14 N {14 gf} | 0.06 N {6 gf} | --- | |
| Pretravel | PT | Max. | | 4.0 mm | 4.0 mm | | 4.0 mm | 4.0 mm |
| Overtravel | OT | Min. | | 1.6 mm | 1.6 mm | | 1.6 mm | 1.6 mm |
| Movement Differential | MD | Max. | | 0.8 mm | 1.5 mm | | 0.8 mm | 1.5 mm |
| Operating Position | OP | | | 20.7±1.2 mm | | | | |

Note 1. Unless otherwise specified, a tolerance of ±0.4 mm applies to all dimensions.

Note 2. The operating characteristics are for operation in the A direction (↓).

Precautions

★Please refer to "Common Precautions" for correct use.

Cautions

●Handling

Be careful not to drop the switch. Doing so may cause damage to the switch's internal components because it is designed for a small load.

Correct Use

●Mounting

Use two M3 mounting screws with an appropriate screwdriver to mount the switch. Tighten the screws to a torque of 0.39 to 0.59 N·m {4 to 6 kgf·cm}.

●Mounting Direction

Mount lever-operated switches with a maximum operating force of 0.49 N in a direction where the actuator weight will not be applied to the switch. Since the switch is designed for a small load, its resetting force is small. Therefore, resetting failure may occur if unnecessary load is applied to the switch.

●Insulation Distance

According to EN61058-1, the minimum insulation thickness for this switch should be 1.1 mm and minimum clearance distance between the terminal and mounting plate should be 1.9 mm. If the insulation distance cannot be provided in the product incorporating the switch, either use a switch with insulation barrier or use a Separator to ensure sufficient insulation distance.

●Using Micro Loads

Using a model for ordinary loads to open or close the contact of a micro load circuit may result faulty contact. Use models that operate in the following range. However, even when using micro load models within the operating range shown below, if inrush current occurs when the contact is opened or closed, it may increase contact wear and so decrease durability. Therefore, insert a contact protection circuit where necessary.

The minimum applicable load is the N-level reference value. This value indicates the malfunction reference level for the reliability level of 60% (λ_{60}). The equation, $\lambda_{60} = 0.5 \times 10^{-6}/\text{operations}$ indicates that the estimated malfunction rate is less than 1/2,000,000 operations with a reliability level of 60%.

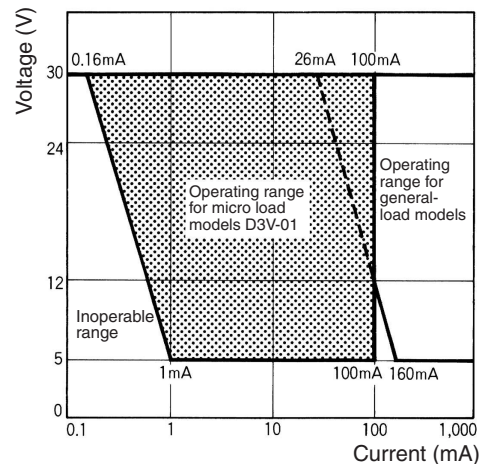

●Solder Terminal Approval Conditions

| |
|---|
| Soldering iron can be used. Soldering hook hole available. |
| Soldering terminal types 1 and 2 are met. |

Actuator (Sold Separately)

Various Actuators are available as shown on D3V/V/VX/D2MV/D2RV Common Accessories.

Connector (Sold Separately)

Refer to Terminal Connectors.

• Application examples provided in this document are for reference only. In actual applications, confirm equipment functions and safety before using the product.
• Consult your OMRON representative before using the product under conditions which are not described in the manual or applying the product to nuclear control systems, railroad systems, aviation systems, vehicles, combustion systems, medical equipment, amusement machines, safety equipment, and other systems or equipment that may have a serious influence on lives and property if used improperly. Make sure that the ratings and performance characteristics of the product provide a margin of safety for the system or equipment, and be sure to provide the system or equipment with double safety mechanisms.

Note: Do not use this document to operate the Unit.