





HESTORE.HU

elektronikai alkatrész áruház

EN: This Datasheet is presented by the manufacturer.

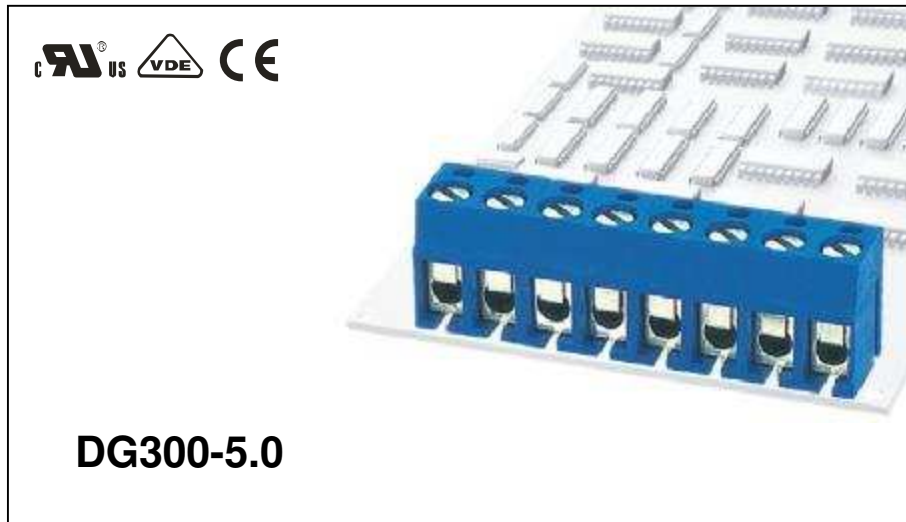
Please visit our website for pricing and availability at www.hestore.hu.



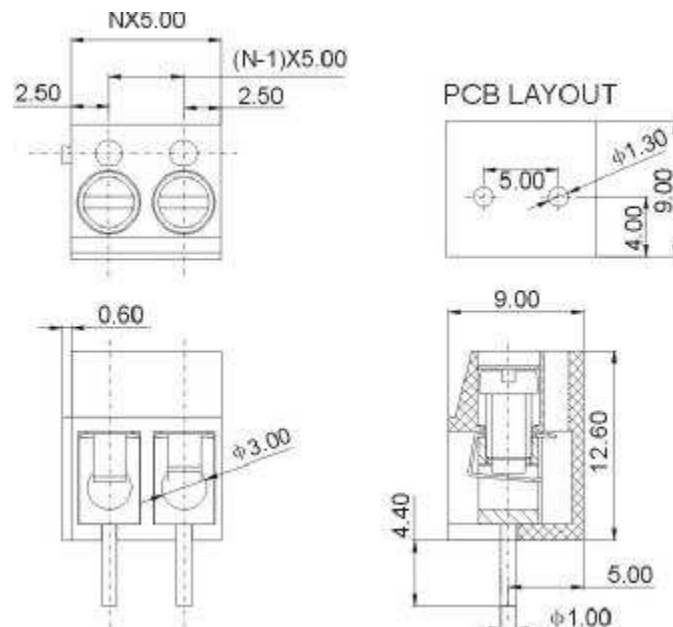

APPROVAL		
Electrical		
Standard	UL	IEC
Rated voltage	300V	250V
Rated current	10A	24A
Wire range	22-14AWG	2.5mm ²
Withstanding voltage	AC2000V/1Min	
Mechanical		
Torque	0.5Nm(4.4Lb-In)	
Ambient temperature	-30°C~+120 °C	
Strip length	5-6mm	
Dimensions		
Pitch	5.0mm(.197")	
Poles	2P,3P-24P	
Material		
Housing	PBT,UL94V-0	
Screws	M3,steel, Cr ³⁺ Zn-plated	
Pin header	Brass,Tin plated	
Wire guard	Stainless steel	

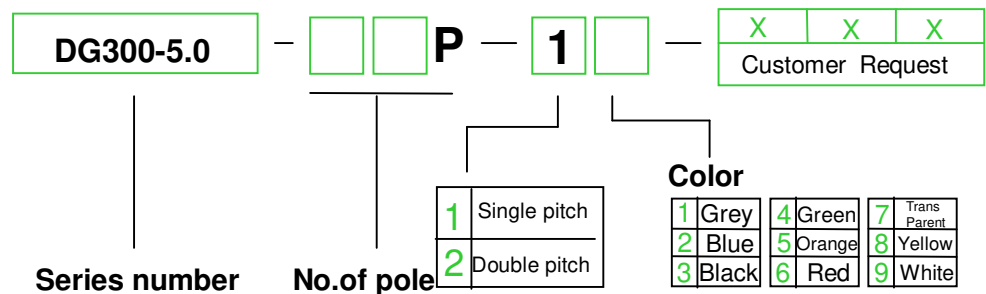

HOW TO ORDER :

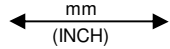

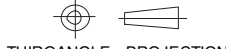
	 DEGSON ELECTRONICS CO., LTD.
	NAME DG300-5.0