



**HESTORE.HU**

elektronikai alkatrész áruház

**EN:** This Datasheet is presented by the manufacturer.

Please visit our website for pricing and availability at [www.hestore.hu](http://www.hestore.hu).

### General Description

MIC20XX family of switches are current limiting, high-side power switches, designed for general purpose power distribution and control in digital televisions (DTV), printers, set top boxes (STB), PCs, PDAs, and other peripheral devices (see *Functionality Table* and *Pin Configuration* drawings)

MIC20XX family's primary functions are current limiting and power switching. They are thermally protected and will shutdown should their internal temperature reach unsafe levels, protecting both the device and the load, under high-current or fault conditions

Features include fault reporting, fault blanking to eliminate noise-induced false alarms, output slew rate limiting, under voltage detection, automatic-on output, and enable pin with choice of either active low or active high enable. The FET is self-contained, with a fixed- or user-adjustable current limit. The MIC20XX family is ideal for any system where current limiting and power control are desired.

The MIC201X ( $3 \leq x \leq 9$ ) and MIC2019A switches offer a unique new patented feature: Kickstart™, which allows momentary high-current surges up to the secondary current limit ( $I_{LIMIT\_2nd}$ ) without sacrificing overall system safety.

The MIC20xx family is offered, depending on the desired features, in a space-saving 5-pin SOT-23, 6-pin SOT-23, and 2mm x 2mm MLF® packages.

Datasheets and support documentation can be found on Micrel's web site at: [www.micrel.com](http://www.micrel.com).

### Features

- **MIC20X3 – MIC20X9**  
70mΩ typical on-resistance @ 5V
- **MIC2005A/20X9A**  
170mΩ typical on-resistance @ 5V
- Enable active high or active low
- 2.5V – 5.5V operating range
- Pre-set current limit values of 0.5A, 0.8A, and 1.2A\*
- Adjustable current limit 0.2A to 2.0A\* (MIC20X7-MIC20X9)
- Adjustable current limit 0.1A to 0.9A\* (MIC20X9A)
- Undervoltage lock-out (UVLO)
- Variable UVLO allows adjustable UVLO thresholds\*
- Automatic load discharge for capacitive loads\*
- Soft-start prevents large current inrush
- Adjustable slew rate allows custom slew rates\*
- Automatic-on output after fault
- Thermal protection

\* Available on some family members

### Applications

- Digital televisions (DTV)
- Set top boxes
- PDAs
- Printers
- USB / IEEE 1394 power bus distribution
- Desktop and laptop PCs
- Game consoles
- Docking stations

### Typical Application

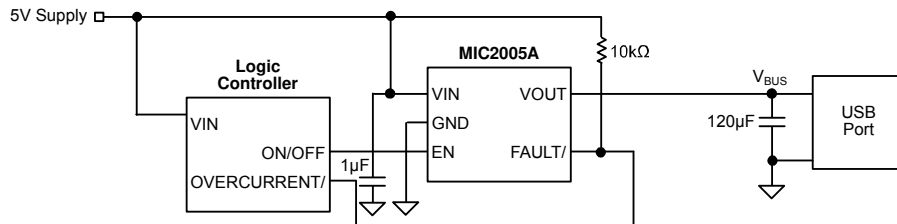


Figure 1. Typical Application Circuit

Kickstart is a trademark of Micrel, Inc.

MLF and MicroLeadFrame are registered trademarks of Amkor Technology, Inc.

CableCARD is a trademark of CableLabs.

Protected by U.S. Patent No. 7,170,732

## Ordering Information

### MIC2003/2013

Part Number <sup>(1)</sup>	Marking <sup>(2)</sup>	Current Limit	Kickstart™	Package
MIC2003-0.5YM5	<u>FD</u> 05	0.5A	No	5-Pin SOT-23
MIC2003-0.8YM5	<u>FD</u> 08	0.8A		
MIC2003-1.2YM5	<u>FD</u> 12	1.2A		
MIC2003-0.5YML	<u>D</u> 05	0.5A		6-Pin 2mm x 2mm MLF®
MIC2003-0.8YML	<u>D</u> 08	0.8A		
MIC2003-1.2YML	<u>D</u> 12	1.2A		
MIC2013-0.5YM5	<u>FL</u> 05	0.5A	Yes	5-Pin SOT-23
MIC2013-0.8YM5	<u>FL</u> 08	0.8A		
MIC2013-1.2YM5	<u>FL</u> 12	1.2A		
MIC2013-0.5YML	<u>L</u> 05	0.5A		6-Pin 2mm x 2mm MLF®
MIC2013-0.8YML	<u>L</u> 09	0.8A		
MIC2013-1.2YML	<u>L</u> 12	1.2A		

### MIC2004/2014

Part Number <sup>(1)</sup>	Marking <sup>(2)</sup>	Current Limit	Kickstart™	Package
MIC2004-0.5YM5	<u>FE</u> 05	0.5A	No	5-Pin SOT-23
MIC2004-0.8YM5	<u>FE</u> 08	0.8A		
MIC2004-1.2YM5	<u>FE</u> 12	1.2A		
MIC2004-0.5YML	<u>E</u> 05	0.5A		6-Pin 2mm x 2mm MLF®
MIC2004-0.8YML	<u>E</u> 08	0.8A		
MIC2004-1.2YML	<u>E</u> 12	1.2A		
MIC2014-0.5YM5	<u>FM</u> 05	0.5A	Yes	5-Pin SOT-23
MIC2014-0.8YM5	<u>FM</u> 08	0.8A		
MIC2014-1.2YM5	<u>FM</u> 12	1.2A		
MIC2014-0.5YML	<u>M</u> 05	0.5A		6-Pin 2mm x 2mm MLF®
MIC2014-0.8YML	<u>M</u> 09	0.8A		
MIC2014-1.2YML	<u>M</u> 12	1.2A		

#### Notes:

- All MIC20XX Family parts are RoHS-compliant lead free.
- Over/Under-bar symbol (   /   ) may not be to scale. On the package the over/under symbol begins above/below the first character of the marking.

## Ordering Information (Continued)

### MIC2005

Part Number <sup>(1)</sup>	Marking <sup>(2)</sup>	Current Limit	Enable	Kickstart™	Package
MIC2005-0.5YM6	<u>FF</u> 05	0.5A	Active High	No	6-Pin SOT-23
MIC2005-0.8YM6	<u>FF</u> 08	0.8A	Active High		
MIC2005-1.2YM6	<u>FF</u> 12	1.2A	Active High		
MIC2005-0.5YML	<u>F</u> 05	0.5A	Active High		6-Pin 2mm x 2mm MLF®
MIC2005-0.8YML	<u>F</u> 08	0.8A	Active High		
MIC2005-1.2YML	<u>F</u> 12	1.2A	Active High		

### MIC2005L

Part Number <sup>(1)</sup>	Marking <sup>(2)</sup>	Current Limit	Enable	Kickstart™	Package
MIC2005-0.5LYM5	<u>5L</u> FF	0.5A	Active Low	No	5-Pin SOT-23
MIC2005-0.8LYM5	<u>8L</u> FF	0.8A	Active Low		
MIC2005-1.2LYM5	<u>4L</u> FF	1.2A	Active Low		

### MIC2005A

Part Number <sup>(1)</sup>	Marking <sup>(2)</sup>	Current Limit	Enable	Kickstart™	Package
MIC2005A-1YM5	<u>FA</u> 51	0.5A	Active High	No	5-Pin SOT-23
MIC2005A-2YM5	<u>FA</u> 52	0.5A	Active Low		
MIC2005A-1YM6	<u>FA</u> 53	0.5A	Active High		6-Pin SOT-23
MIC2005A-2YM6	<u>FA</u> 54	0.5A	Active Low		

### MIC2015

Part Number <sup>(1)</sup>	Marking <sup>(2)</sup>	Current Limit	Enable	Kickstart™	Package
MIC2015-0.5YM6	<u>FN</u> 05	0.5A	Active High	Yes	6-Pin SOT-23
MIC2015-0.8YM6	<u>FN</u> 08	0.8A	Active High		
MIC2015-1.2YM6	<u>FN</u> 12	1.2A	Active High		
MIC2015-0.5YML	<u>N</u> 05	0.5A	Active High		6-Pin 2mm x 2mm MLF®
MIC2015-0.8YML	<u>N</u> 08	0.8A	Active High		
MIC2015-1.2YML	<u>N</u> 12	1.2A	Active High		

#### Notes:

- All MIC20XX Family parts are RoHS-compliant lead free.
- Over/Under-bar symbol (   /   ) may not be to scale. On the package the over/under symbol begins above/below the first character of the marking.

## Ordering Information (Continued)

### MIC2006/2016

Part Number <sup>(1)</sup>	Marking <sup>(2)</sup>	Current Limit	Kickstart™	Package
MIC2006-0.5YM6	<u>FG</u> 05	0.5A	No	6-Pin SOT-23
MIC2006-0.8YM6	<u>FG</u> 08	0.8A		
MIC2006-1.2YM6	<u>FG</u> 12	1.2A		
MIC2006-0.5YML	<u>G</u> 05	0.5A		6-Pin 2mm x 2mm MLF®
MIC2006-0.8YML	<u>G</u> 08	0.8A		
MIC2006-1.2YML	<u>G</u> 12	1.2A		
MIC2016-0.5YM6	<u>FP</u> 05	0.5A	Yes	6-Pin SOT-23
MIC2016-0.8YM6	<u>FP</u> 08	0.8A		
MIC2016-1.2YM6	<u>FP</u> 12	1.2A		
MIC2016-0.5YML	<u>P</u> 05	0.5A		6-Pin 2mm x 2mm MLF®
MIC2016-0.8YML	<u>P</u> 09	0.8A		
MIC2016-1.2YML	<u>P</u> 12	1.2A		

### MIC2007/2017

Part Number <sup>(1)</sup>	Marking <sup>(2)</sup>	Current Limit	Kickstart™	Package
MIC2007YM6	<u>FH</u> AA	0.2A – 2.0A	No	6-Pin SOT-23
MIC2007YML	<u>H</u> AA			6-Pin 2mm x 2mm MLF®
MIC2017YM6	<u>FQ</u> AA		Yes	6-Pin SOT-23
MIC2017YML	<u>Q</u> AA			6-Pin 2mm x 2mm MLF®

### MIC2008/2018

Part Number <sup>(1)</sup>	Marking <sup>(2)</sup>	Current Limit	Kickstart™	Package
MIC2008YM6	<u>FJ</u> AA	0.2A – 2.0A	No	6-Pin SOT-23
MIC2008YML	<u>J</u> AA			6-Pin 2mm x 2mm MLF®
MIC2018YM6	<u>FR</u> AA		Yes	6-Pin SOT-23
MIC2018YML	<u>R</u> AA			6-Pin 2mm x 2mm MLF®

### MIC2009/2019

Part Number <sup>(1)</sup>	Marking <sup>(2)</sup>	Current Limit	Kickstart™	Package
MIC2009YM6	<u>FK</u> AA	0.2A – 2.0A	No	6-Pin SOT-23
MIC2009YML	<u>K</u> AA			6-Pin 2mm x 2mm MLF®
MIC2019YM6	<u>FS</u> AA		Yes	6-Pin SOT-23
MIC2019YML	<u>S</u> AA			6-Pin 2mm x 2mm MLF®

#### Notes:

- All MIC20XX Family parts are RoHS-compliant lead free.
- Over/Under-bar symbol (   /   ) may not be to scale. On the package the over/under symbol begins above/below the first character of the marking.

## Ordering Information (Continued)

### MIC2009A/2019A

Part Number <sup>(1)</sup>	Marking <sup>(2)</sup>	Current Limit	Kickstart™	Enable	Package
MIC2009A-1YM6	FK1	0.1 A – 0.9 A	No	Active High	6-pin SOT-23
MIC2009A-2YM6	FK2			Active Low	
MIC2019A-1YM6	FS1		Yes	Active High	
MIC2019A-2YM6	FS2			Active Low	

#### Notes:

- All MIC20XX Family parts are RoHS-compliant lead free.
- Over/Under-bar symbol ( ¯ / \_ ) may not be to scale. On the package the over/under symbol begins above/below the first character of the marking.

## MIC20XX Family Member Functionality

Part Number		I <sub>LIMIT</sub>	Pin Function						
Normal Limiting	Kickstart™ <sup>(1)</sup>		I <sub>LIMIT</sub>	ENABLE High	ENABLE Low	CSLEW	FAULT/	VUVLO <sup>(5)</sup>	Load Discharge
2003	2013	Fixed <sup>(2)</sup>	–	–	–	–	–	–	–
2004	2014		–	▲	–	–	–	–	▲
2005	2015		–	▲	–	▲	▲	–	–
2005L	– <sup>(1)</sup>		–	–	▲	–	▲	–	–
2005A-1	– <sup>(1)</sup>		–	▲	–	– <sup>(6)</sup>	▲	–	–
2005A-2	– <sup>(1)</sup>		–	–	▲	– <sup>(6)</sup>	▲	–	–
2006	2016		–	▲	–	▲	–	▲	–
2007	2017	Adj. <sup>(3)</sup>	▲	▲	–	▲	–	–	▲
2008	2018		▲	▲	–	▲	–	–	–
2009	2019		▲	▲	–	–	▲	–	–
2009A-1	2019A-1		▲	▲	–	–	▲	–	–
2009A-2	2019A-2		▲	–	▲	–	▲	–	–

#### Notes:

- Kickstart™ provides an alternate start-up behavior; however, pin-outs are identical.
- Kickstart™ not available.
- Fixed = Factory-programmed current limit.
- Adj. = User adjustable current limit.
- VUVLO = Variable UVLO (Previously called DML).
- CSLEW not available in 5-pin package.

## MIC20XX Family Member Pin Configuration Table, SOT Packages

Part Number		I <sub>LIMIT</sub>	Pin Number					
Normal Limiting	Kickstart™		1	2	3	4	5	6
2003	2013	Fixed <sup>(2)</sup>	VIN	GND	NC	NC	VOUT	—
2004	2014		VIN	GND	EN	NC	VOUT	—
2005	2015		VIN	GND	EN	FAULT/	CSLEW	VOUT
2005L	— <sup>(1)</sup>		VIN	GND	EN	FAULT/	VOUT	—
2005Axxx6	— <sup>(1)</sup>		VIN	GND	EN	FAULT/	CSLEW	VOUT
2005Axxx5	— <sup>(1)</sup>		VIN	GND	EN	FAULT/	VOUT	—
2006	2016		VIN	GND	EN	VUVLO <sup>(4)</sup>	CSLEW	VOUT
2007	2017	Adj. <sup>(3)</sup>	VIN	GND	EN	ILIMIT	CSLEW	VOUT
2008	2018		VIN	GND	EN	ILIMIT	CSLEW	VOUT
2009	2019		VIN	GND	EN	FAULT/	ILIMIT	VOUT
2009A	2019A		VIN	GND	EN	FAULT/	ILIMIT	VOUT

### Notes:

1. Kickstart™ not available.
2. Fixed = Factory-programmed current limit.
3. I<sub>LIMIT</sub> = User adjustable current limit.
4. VUVLO = Variable UVLO (Previously called DLM).

## MIC20XX Family Member Pin Configuration Table, MLF<sup>®</sup> Packages <sup>(5)</sup>

Part Number		I Limit	Pin Number					
Normal Limiting	Kickstart™		6	5	4	3	2	1
2003	2013	Fixed <sup>(2)</sup>	VIN	GND	NC	NC	NC	VOUT
2004	2014		VIN	GND	EN	NC	NC	VOUT
2005	2015		VIN	GND	EN	FAULT/	CSLEW	VOUT
2006	2016		VIN	GND	EN	VUVLO <sup>(4)</sup>	CSLEW	VOUT
2007	2017	Adj. <sup>(3)</sup>	VIN	GND	EN	ILIMIT	CSLEW	VOUT
2008	2018		VIN	GND	EN	ILIMIT	CSLEW	VOUT
2009	2019		VIN	GND	EN	FAULT/	ILIMIT	VOUT

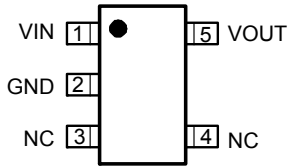
### Notes:

1. Kickstart™ not available.
2. Fixed = Factory-programmed current limit.
3. I<sub>LIMIT</sub> = User adjustable current limit.
4. VUVLO = Variable UVLO (Previously called DLM).
5. Connect EP to GND.

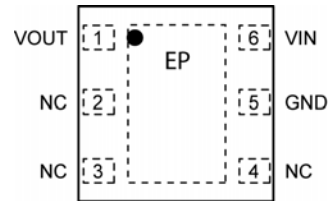
## MIC20XX Family Member Pin Configuration Drawings

### Fixed Current Limit

#### MIC20X3

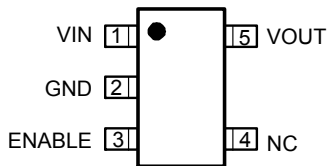


5-Pin SOT-23 (M5)

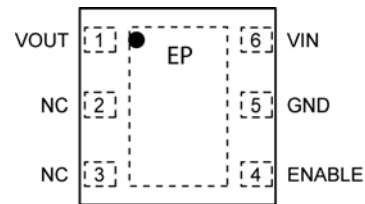


6-Pin MLF<sup>®</sup> (ML)  
(Top View)

#### MIC20X4

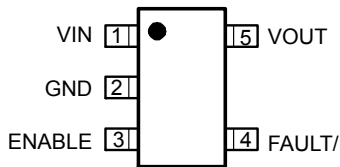


5-Pin SOT-23 (M5)

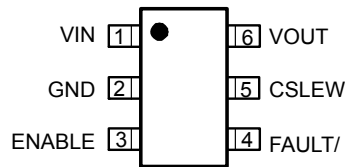


6-Pin MLF<sup>®</sup> (ML)  
(Top View)

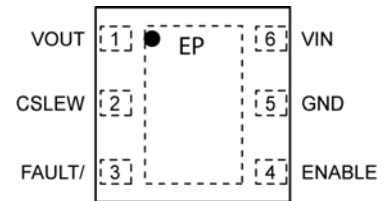
#### MIC20X5



5-Pin SOT-23 (M5)  
MIC2005-X.XL

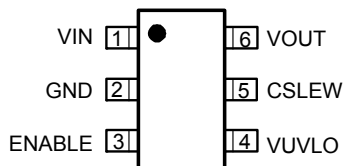


6-Pin SOT-23 (M6)  
MIC20X5

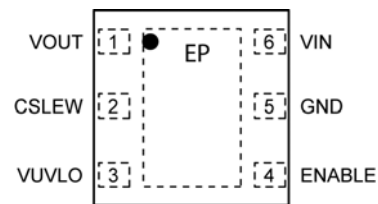


6-Pin MLF<sup>®</sup> (ML)  
(Top View)  
MIC20X5

#### MIC20X6



6-Pin SOT-23 (M6)



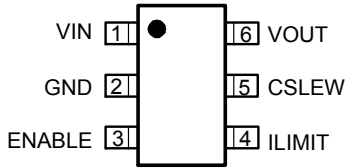
6-Pin MLF<sup>®</sup> (ML)  
(Top View)



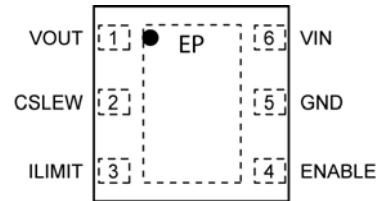
## MIC20XX Family Member Pin Configuration Drawings (Continued)

### Adjustable Current Limit

#### MIC20X7/20X8

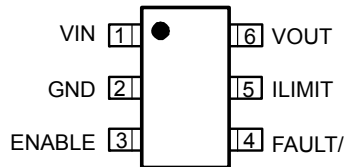


6-Pin SOT-23 (M6)

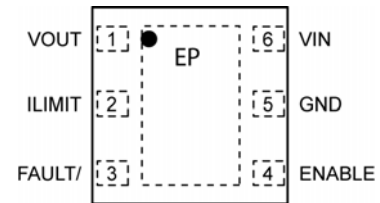


6-Pin MLF<sup>®</sup> (ML)  
(Top View)

#### MIC20X9

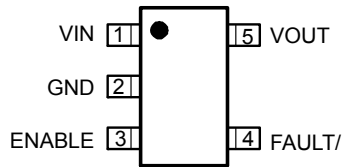


6-Pin SOT-23 (M6)

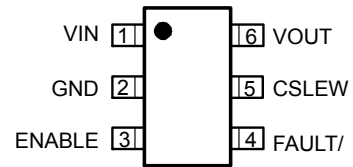


6-Pin MLF<sup>®</sup> (ML)  
(Top View)

#### MIC2005A

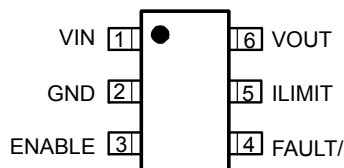


5-Pin SOT-23 (M5)



6-Pin SOT-23 (M6)

#### MIC2009A



6-Pin SOT-23 (M6)

## Descriptions

These pin and signal descriptions aid in the differentiation of a pin from electrical signals and components connected to that pin. For example, VOUT is the switch's output pin, while  $V_{OUT}$  is the electrical signal output voltage present at the VOUT pin.

## Pin Descriptions

Pin Name	Type	Description
VIN	Input	Supply input. This pin provides power to both the output switch and the switch's internal control circuitry.
GND	—	Ground.
EN	Input	Switch Enable (Input):
FAULT/	Output	Fault status. A logic LOW on this pin indicates the switch is in current limiting, or has been shut down by the thermal protection circuit. This is an open-drain output allowing logical OR'ing of multiple switches.
CSLEW	Input	Slew rate control. Adding a small value capacitor between this pin and VIN slows turn-ON of the power FET.
VOUT	Output	Switch output. The load being driven by the switch is connected to this pin.
VUVLO	Input	Variable Under Voltage Lockout (VUVLO): Monitors the input voltage through a resistor divider between VIN and GND. Shuts the switch off if voltage falls below the threshold set by the resistor divider. Previously called VUVLO.
ILIMIT	Input	Set current limit threshold via a resistor connected from ILIMIT to GND.
EP	Thermal	On MLF packages connect EP to GND.

## Signal Descriptions

Signal Name	Type	Description
$V_{IN}$	Input	Electrical signal input voltage present at the VIN pin.
GND	—	Ground.
$V_{EN}$	Input	Electrical signal input voltage present at the ENABLE pin.
$V_{FAULT/}$	Output	Electrical signal output voltage present at the FAULT/ pin.
$C_{SLEW}$	Component	Capacitance value connected to the CSLEW pin.
$V_{OUT}$	Output	Electrical signal output voltage present at the VOUT pin.
$V_{VUVLO\_TH}$	Internal	VUVLO internal reference threshold voltage. This voltage is compared to the VUVLO pin input voltage to determine if the switch should be disabled. Reference threshold voltage has a typical value of 250mV.
$C_{LOAD}$	Component	Capacitance value connected in parallel with the load. Load capacitance.
$I_{OUT}$	Output	Electrical signal output current present at the VOUT pin.
$I_{LIMIT}$	Internal	Switch's current limit. Fixed at factory or user adjustable.

### Absolute Maximum Ratings<sup>(1)</sup>

$V_{IN}$ ,  $V_{OUT}$ .....-0.3V to 6V  
 All other pins.....-0.3V to 5.5V  
 Power Dissipation ( $P_D$ ) ..... Internally Limited  
 Continuous Output Current  
     All except MIC2005A / MIC20X9A..... 2.25A  
     MIC2005A / 20X9A..... 1.0A  
 Maximum Junction Temperature ( $T_J$ )..... 150°C  
 Storage Temperature ( $T_S$ )..... -65°C to +150°C  
 Lead Temperature (Soldering 10 sec)..... 260°C

### Operating Ratings<sup>(2)</sup>

Supply Voltage..... 2.5V to 5.5V  
 Continuous Output Current  
     All except MIC2005A / MIC20X9A ..... 0A to 2.1A  
     MIC2005A/20X9A..... 0A to 0.9A  
 Ambient Temperature Range ( $T_A$ ).....-40°C to +85°C  
 Package Thermal Resistance<sup>(3)</sup>  
     SOT-23-5/6 ( $\theta_{JA}$ ) .....230°C /W  
     2mm × 2mm MLF<sup>®</sup> ( $\theta_{JA}$ ) .....90°C /W  
     2mm × 2mm MLF<sup>®</sup> ( $\theta_{JC}$ ) .....45°C /W

### Electrical Characteristics<sup>(4)</sup>

$V_{IN} = 5V$ ,  $T_A = 25^\circ C$  unless otherwise specified. **Bold** indicates -40°C to +85°C limits;  $C_{IN} = 1\mu F$ .

Symbol	Parameter	Condition	Min.	Typ.	Max.	Units
$V_{IN}$	Switch Input Voltage		<b>2.5</b>		<b>5.5</b>	V
$I_{LEAK}$	Output Leakage Current <sup>(5)</sup>	Switch = OFF, $V_{OUT} = 0V$ Active Low Enable, $V_{EN} = 1.5V$ Active High Enable, $V_{EN} = 0V$		12	<b>100</b>	$\mu A$
<b>MIC2005A, MIC2009A, MIC2019A</b>						
$I_{IN}$	Supply Current <sup>(5)</sup>	Switch = ON Active Low Enable, $V_{EN} = 0V$ Active High Enable, $V_{EN} = 1.5V$		80	<b>300</b>	$\mu A$
		Switch = OFF Active Low Enable, $V_{EN} = 1.5V$		8	<b>15</b>	
		Switch = OFF Active High Enable, $V_{EN} = 0V$		1	<b>5</b>	
$R_{DS(ON)}$	Power Switch Resistance	$V_{IN} = 5V$ , $I_{OUT} = 100mA$		170	220	m $\Omega$
					<b>275</b>	
<b>MIC2005A</b>						
$I_{LIMIT}$	Fixed Current Limit	$V_{OUT} = 0.8 \times V_{IN}$	0.5	0.7	0.9	A
<b>MIC2009A, MIC2019A</b>						
$C_{LF}$	Variable Current Limit Factors	$I_{OUT} = 0.9A$ , $V_{OUT} = 0.8 \times V_{IN}$	172	211	263	V
		$I_{OUT} = 0.5A$ , $V_{OUT} = 0.8 \times V_{IN}$	152	206	263	
		$I_{OUT} = 0.2A$ , $V_{OUT} = 0.8 \times V_{IN}$	138	200	263	
		$I_{OUT} = 0.1A$ , $V_{OUT} = 0.8 \times V_{IN}$	121	192	263	
<b>MIC2019A</b>						
$I_{LIMIT\_2nd}$	Secondary Current Limit	$V_{IN} = 2.5V$ , $V_{OUT} = 0V$	1	2	3	A

**Notes:**

- Exceeding the absolute maximum rating may damage the device.
- The device is not guaranteed to function outside its operating rating.
- Requires proper thermal mounting to achieve this performance
- Specifications for packaged product only.
- Check the Ordering Information section to determine which parts are Active High or Active Low.

**Electrical Characteristics<sup>(4)</sup> (Continued)**

$V_{IN} = 5V$ ,  $T_A = 25^\circ C$  unless otherwise specified. **Bold** indicates  $-40^\circ C$  to  $+85^\circ C$  limits;  $C_{IN} = 1\mu F$ .

Symbol	Parameter	Condition	Min.	Typ.	Max.	Units
<b>MIC2003-MIC2009, MIC2013-MIC2019, MIC2005-X.XL</b>						
$I_{IN}$	Supply Current <sup>(5)</sup>	Switch = ON Active Low Enable, $V_{EN} = 0V$ Active High Enable, $V_{EN} = 1.5V$		80	<b>330</b>	$\mu A$
		Switch = OFF Active Low Enable, $V_{EN} = 1.5V$		8	<b>15</b>	
		Switch = OFF Active High Enable, $V_{EN} = 0V$		1	<b>5</b>	
$R_{DS(ON)}$	Power Switch Resistance	$V_{IN} = 5V$ , $I_{OUT} = 100mA$		70	100	$m\Omega$
					<b>125</b>	
<b>MIC2003-X.X, MIC2004-X.X, MIC2005-X.X, MIC2006-X.X, MIC2013-X.X, MIC2014-X.X, MIC2015-X.X, MIC2016-X.X, MIC2005-X.XL</b>						
$I_{LIMIT}$	Fixed Current Limit	$-0.5$ , $V_{OUT} = 0.8 \times V_{IN}$	0.5	0.7	0.9	A
		$-0.8$ , $V_{OUT} = 0.8 \times V_{IN}$	0.8	1.1	1.5	
		$-1.2$ , $V_{OUT} = 0.8 \times V_{IN}$	1.2	1.6	2.1	
<b>MIC2005-0.5</b>						
$I_{LIMIT}$	Fixed Current Limit	$V_{OUT} = 0.8 \times V_{IN}$	<b>0.5</b>	0.7	0.9	A
<b>MIC2007, MIC2008, MIC2009, MIC2017, MIC2018, MIC2019</b>						
$C_{LF}$	Variable Current Limit Factors	$I_{OUT} = 2.0A$ , $V_{OUT} = 0.8 \times V_{IN}$	210	250	286	V
		$I_{OUT} = 1.0A$ , $V_{OUT} = 0.8 \times V_{IN}$	190	243	293	
		$I_{OUT} = 0.5A$ , $V_{OUT} = 0.8 \times V_{IN}$	168	235	298	
		$I_{OUT} = 0.2A$ , $V_{OUT} = 0.8 \times V_{IN}$	144	225	299	
<b>MIC2013, MIC2014, MIC2015, MIC2016, MIC2017, MIC2018, MIC2019</b>						
$I_{LIMIT\_2nd}$	Secondary Current Limit	$V_{IN} = 2.5V$ , $V_{OUT} = 0V$	2.2	4	6	A
<b>MIC2006, MIC2016</b>						
$V_{UVLO\_TH}$	Variable UVLO Threshold		<b>225</b>	250	<b>275</b>	mV
<b>MIC20x4, MIC20x7</b>						
$R_{DSCHG}$	Load Discharge Resistance	$V_{IN} = 5V$ , $I_{SINK} = 5mA$	<b>70</b>	126	<b>200</b>	$\Omega$
<b>MIC20X5, MIC20X6, MIC20X7, MIC20X8</b>						
$I_{CSLEW}$	$C_{SLEW}$ Input Current	$0V \leq V_{OUT} \leq 0.8V_{IN}$		0.175		$\mu A$

**Electrical Characteristics<sup>(4)</sup> (Continued)**

$V_{IN} = 5V$ ,  $T_A = 25^\circ C$  unless otherwise specified. **Bold** indicates  $-40^\circ C$  to  $+85^\circ C$  limits;  $C_{IN} = 1\mu F$ .

Symbol	Parameter	Condition	Min.	Typ.	Max.	Units
<b>All Parts</b>						
$V_{EN}$	ENABLE Input Voltage <sup>(6)</sup>	$V_{IL}$ (MAX)			<b>0.5</b>	V
		$V_{IH}$ (MIN)	<b>1.5</b>			
$I_{EN}$	ENABLE Input Current	$0V \leq V_{EN} \leq 5V$		1	5	$\mu A$
$UVLO_{THRESHOLD}$	Undervoltage Lock-Out Threshold	$V_{IN}$ Rising	<b>2</b>	2.25	<b>2.5</b>	V
		$V_{IN}$ Falling	<b>1.9</b>	2.15	<b>2.4</b>	
$UVLO_{HYSTERESIS}$	Undervoltage Lock-Out Hysteresis			0.1		V
$V_{FAULT}$	Fault Status Output Voltage	$I_{OL} = 10mA$		0.25	<b>0.4</b>	V
$OT_{THRESHOLD}$	Over-Temperature Threshold	$T_J$ Increasing		145		$^\circ C$
		$T_J$ Decreasing		135		

**Note:**

6.  $V_{IL(MAX)}$  = Maximum positive voltage applied to the input which will be accepted by the device as a logic low.  
 $V_{IH(MAX)}$  = Maximum positive voltage applied to the input which will be accepted by the device as a logic high.

## AC Electrical Characteristics

Symbol	Parameter	Condition	Min.	Typ.	Max.	Units
$t_{RISE}$	Output Turn-on rise time	$R_L = 10\Omega$ , $C_{LOAD} = 1\mu F$ , $V_{OUT} = 10\%$ to $90\%$ $C_{SLEW}^{(7)} = Open$	500	1000	1500	$\mu s$
$t_{D\_FAULT}$	Delay before asserting or releasing FAULT/ MIC2003 – MIC2009 MIC2009A, MIC2005A	Time from current limiting to FAULT/ state change	20	32	49	ms
	Delay before asserting or releasing FAULT/ MIC2013 – MIC2019 MIC2019A	Time from $I_{OUT}$ continuously exceeding primary current limit condition to FAULT/ state change	77	128	192	
$t_{D\_LIMIT}$	Delay before current limiting MIC2013 – MIC2019 MIC2019A		77	128	192	ms
$t_{RESET}$	Delay before resetting Kickstart™ current limit delay, $t_{D\_LIMIT}$ MIC2013 – MIC2019 MIC2019A	Out of current limit following a current limit event.	77	128	192	ms
$t_{ON\_DLY}$	Output Turn-on Delay	$R_L = 43\Omega$ , $C_L = 120\mu F$ , $V_{EN} = 50\%$ to $V_{OUT} = 10\%$ * $C_{SLEW} = Open$		1000	1500	$\mu s$
$t_{OFF\_DLY}$	Output Turn-off Delay	$R_L = 43\Omega$ , $C_L = 120\mu F$ , $V_{EN} = 50\%$ to $V_{OUT} = 90\%$ * $C_{SLEW} = Open$			700	$\mu s$

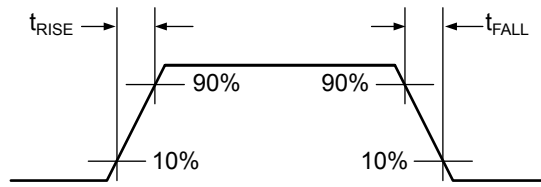
## ESD<sup>(8)</sup>

Symbol	Parameter	Condition	Min.	Typ.	Max.	Units
$V_{ESD\_HB}$	Electro Static Discharge Voltage: Human Body Model	$V_{OUT}$ and GND	$\pm 4$			kV
		All other pins	$\pm 2$			
$V_{ESD\_MCHN}$	Electro Static Discharge Voltage; Machine Model	All pins Machine Model	$\pm 200$			V

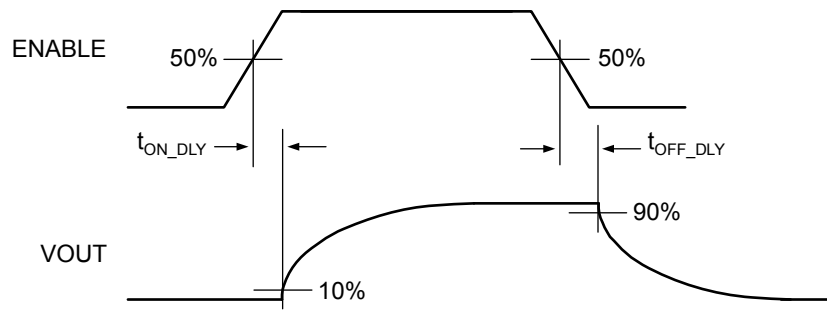
### Notes:

7. Whenever  $C_{SLEW}$  is present.
8. Devices are ESD sensitive. Handling precautions recommended. Human body model, 1.5k in series with 100pF.

### Timing Diagrams



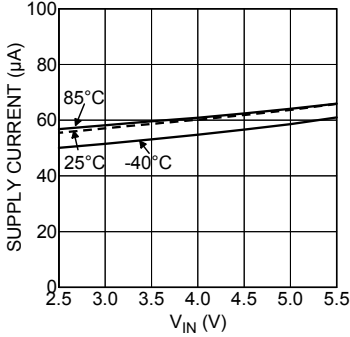
**Rise and Fall Times**



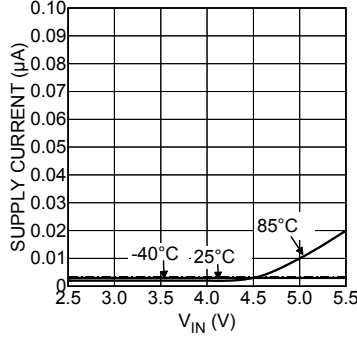
**Switching Delay Times**

# Typical Characteristics

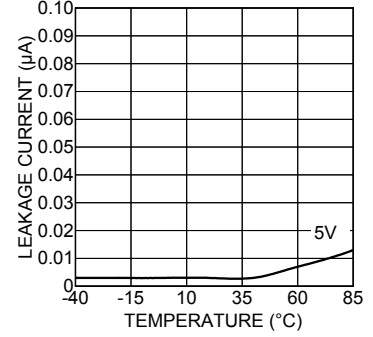
**Supply Current Output Enabled  
MIC20XX**



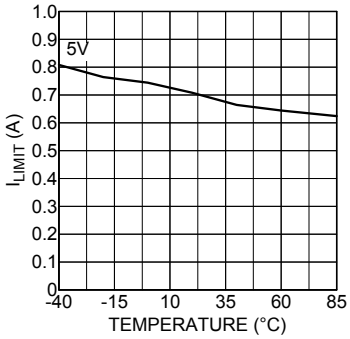
**Supply Current Output Disabled (MIC20XX)**



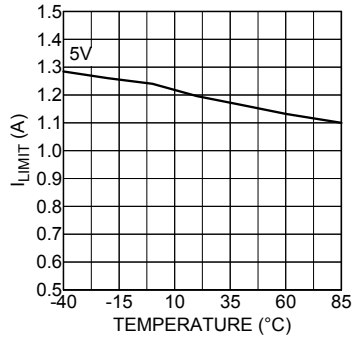
**Switch Leakage Current  
(MIC20XX)**



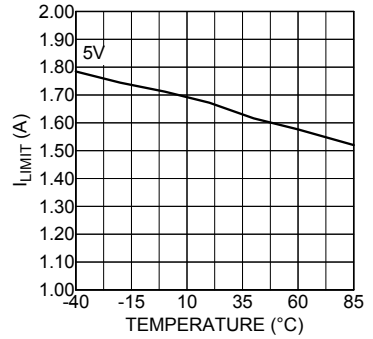
**I<sub>LIMIT</sub> vs. Temperature  
(MIC20XX - 0.5)**



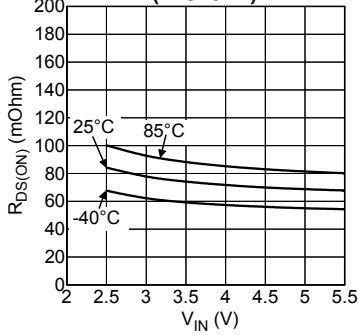
**I<sub>LIMIT</sub> vs. Temperature  
(MIC20XX - 0.8)**



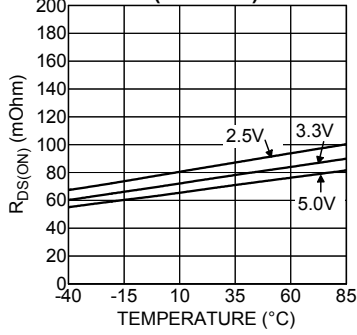
**I<sub>LIMIT</sub> vs. Temperature  
(MIC20XX - 1.2)**



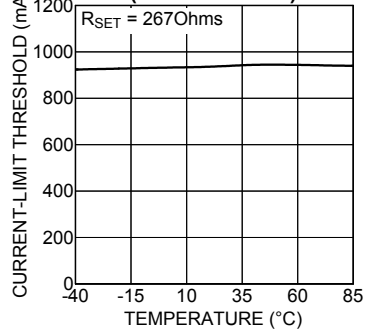
**R<sub>DS(ON)</sub> vs. V<sub>IN</sub>  
(MIC20XX)**



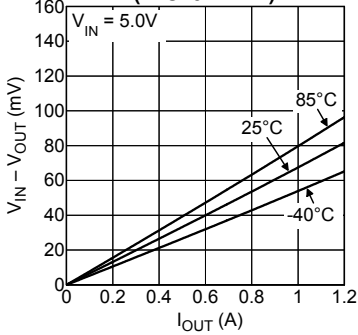
**R<sub>DS(ON)</sub> vs. Temperature  
(MIC20XX)**



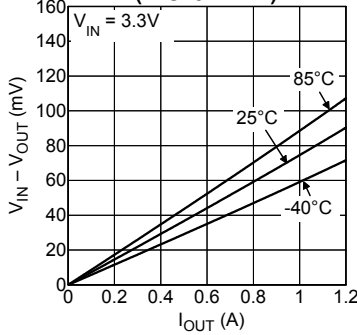
**I<sub>LIMIT</sub> vs. Temperature  
(MIC20X9 - 0.9A)**



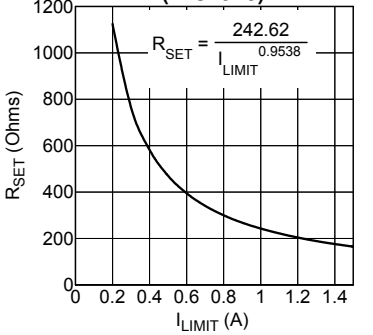
**V<sub>DROP</sub> vs. Temperature  
(MIC20XX-1.2)**



**V<sub>DROP</sub> vs. Temperature  
(MIC20XX-1.2)**



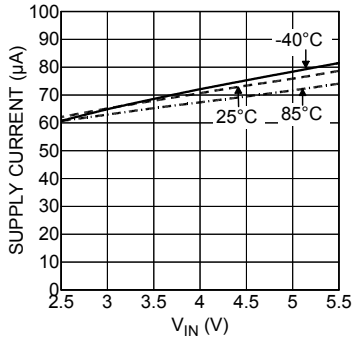
**R<sub>SET</sub> vs. I<sub>LIMIT</sub>  
(MIC20X9)**



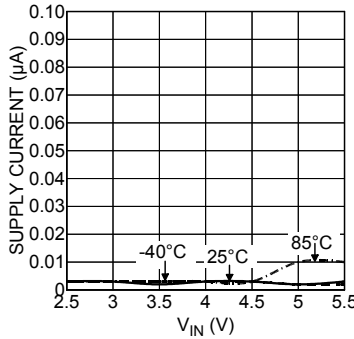


## Typical Characteristics (Continued)

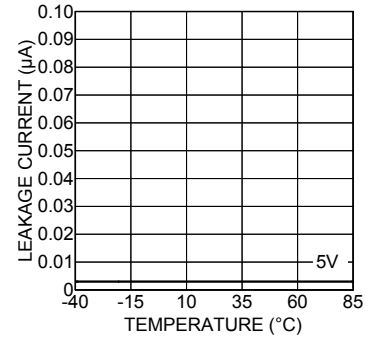
Supply Current Output Enabled (MIC20XXA)



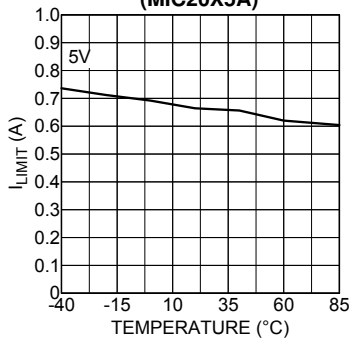
Supply Current Output Disabled (MIC20XXA)



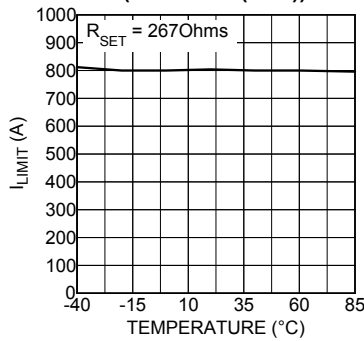
Switch Leakage Current (MIC20XXA)



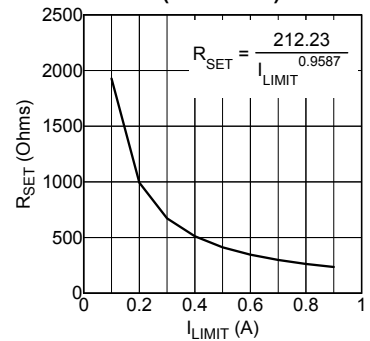
I\_LIMIT vs. Temperature (MIC20X5A)



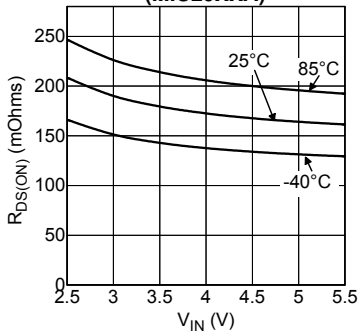
I\_LIMIT vs. Temperature (MIC20X9A (0.8A))



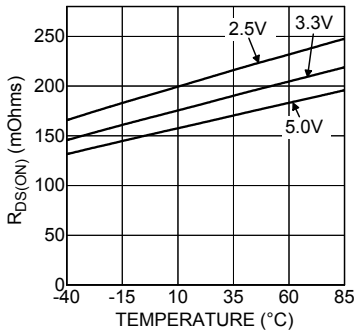
R\_SET vs. I\_LIMIT (MIC20X9A)



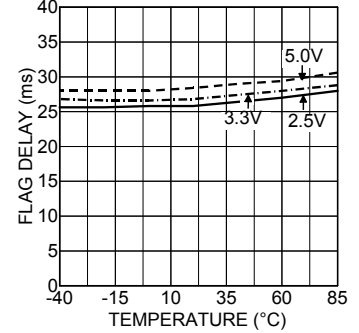
R\_DS(ON) vs. V\_IN (MIC20XXA)



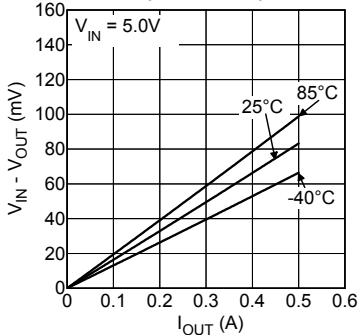
R\_DS(ON) vs. Temperature (MIC20XXA)



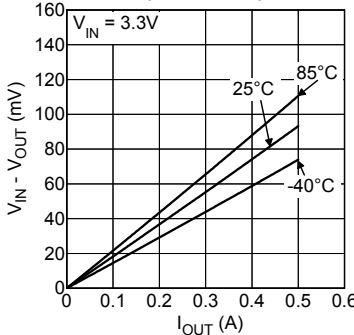
Flag Delay vs. Temperature



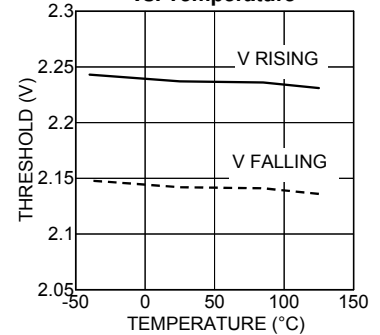
V\_DROP vs. Temperature (MIC20XXA)



V\_DROP vs. Temperature (MIC20XXA)

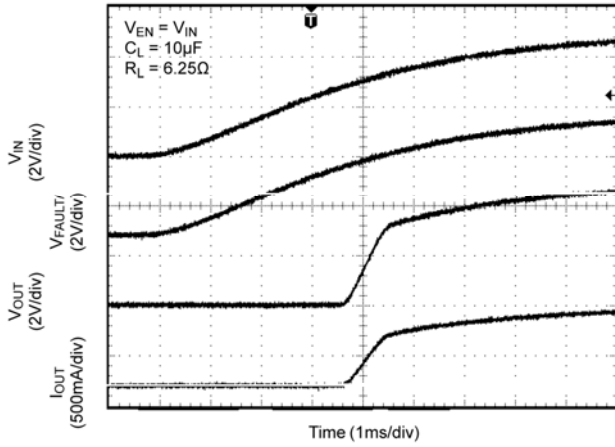


UVLO Threshold vs. Temperature

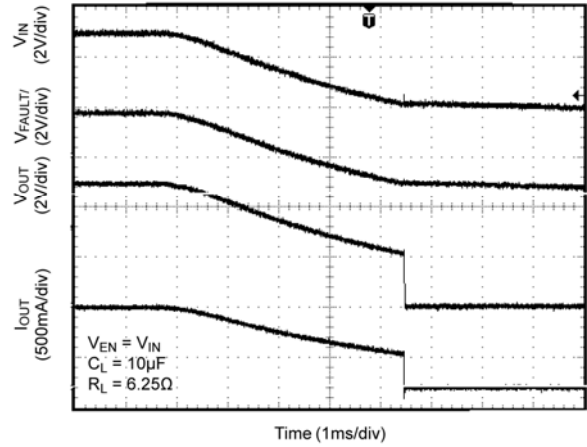


# Functional Characteristics

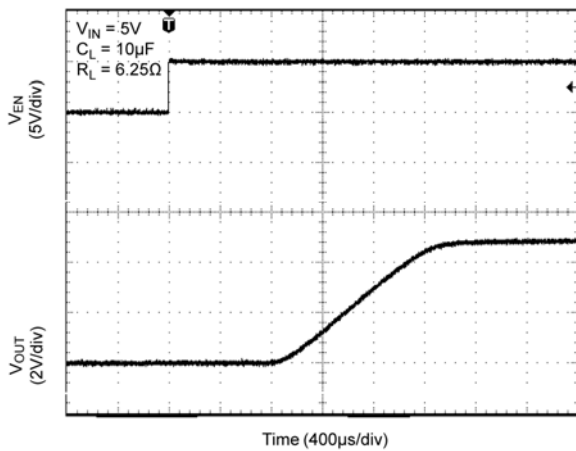
**V<sub>IN</sub> Soft Turn-On**



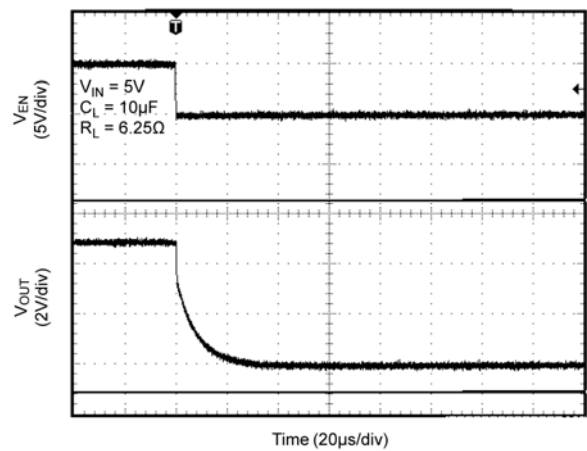
**Turn-Off V<sub>IN</sub>**



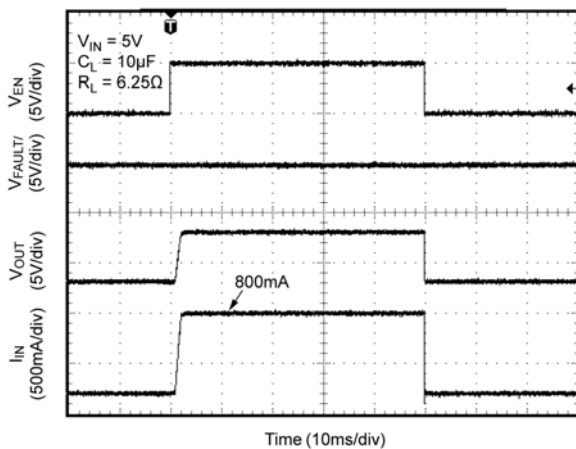
**Enable Turn-On Delay and Rise Time**



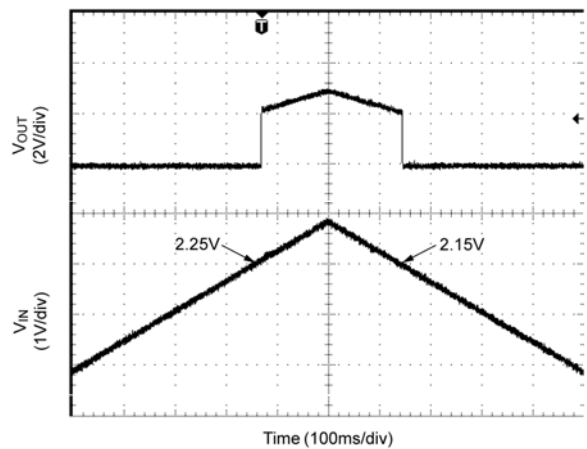
**Enable Turn-Off Delay and Fall Time**



**Enable Turn-On/Turn-Off**

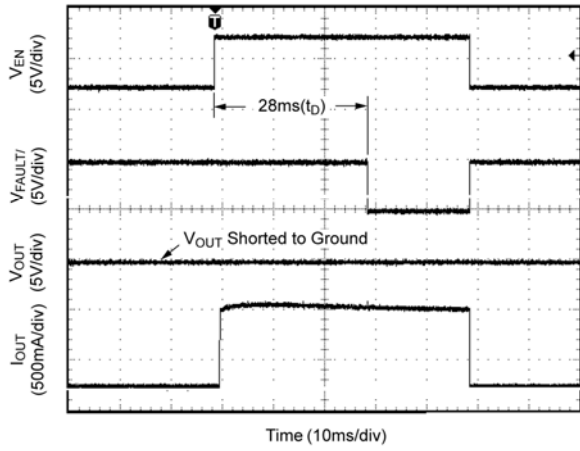


**UVLO**

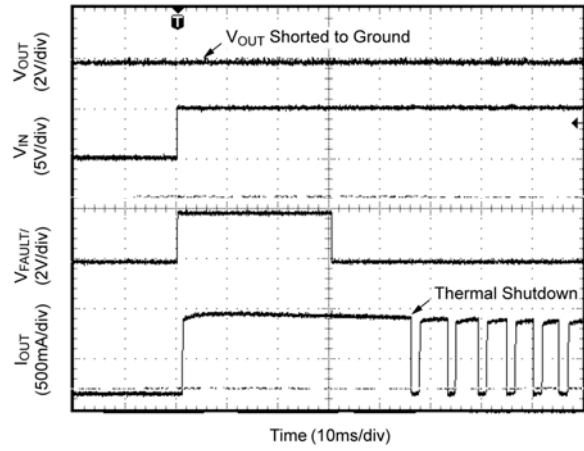


### Functional Characteristics (Continued)

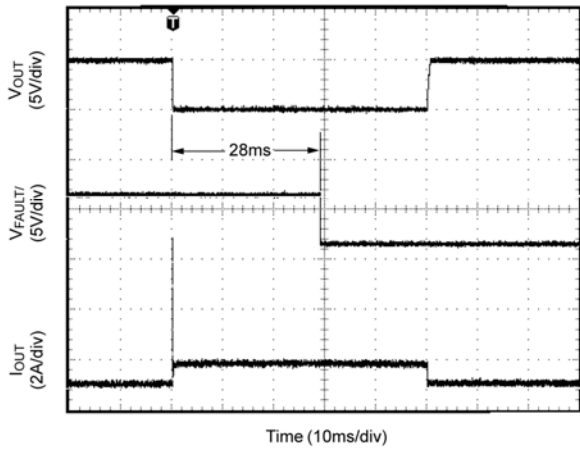
**Enabled into Short**



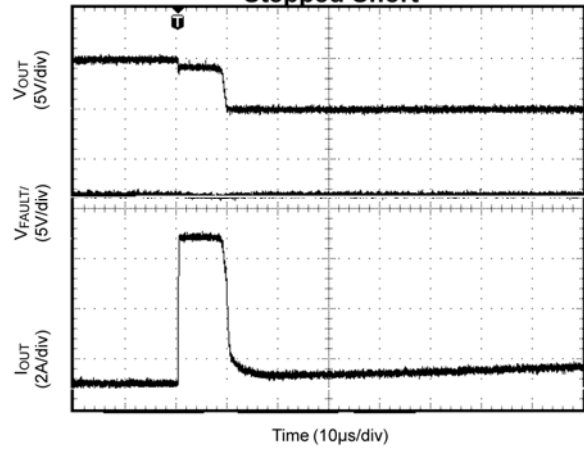
**Power Up into Short Circuit**



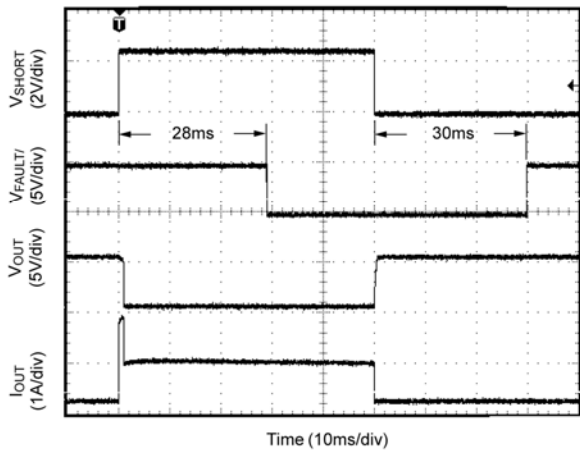
**Current Limit Response, Stepped Short**



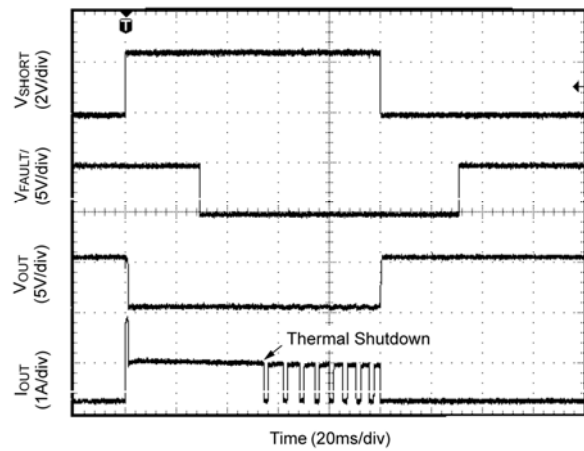
**Current Limit Response Time, Stepped Short**



**Output Recovery from Short Circuit**

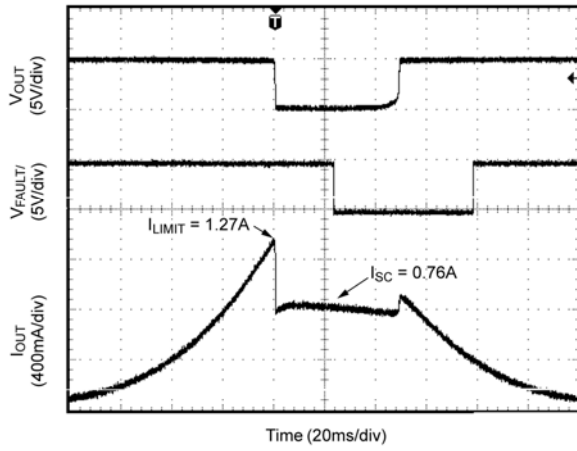


**Output Recovery from Thermal Shutdown**

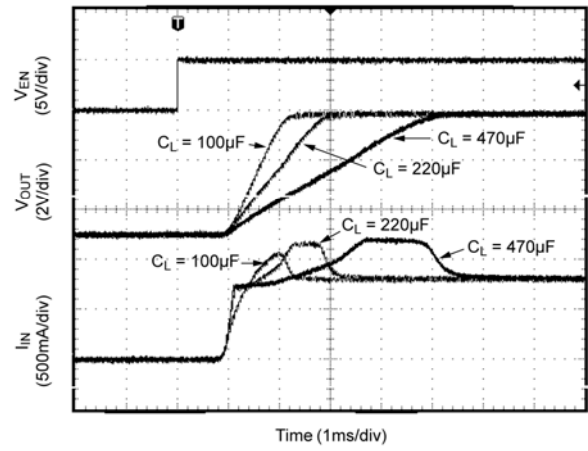


## Functional Characteristics (Continued)

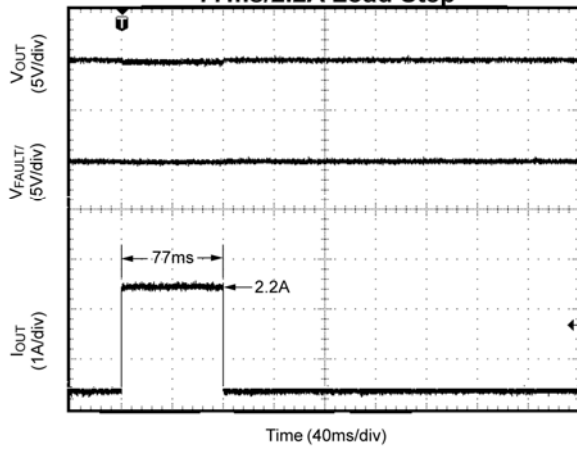
**Current Limit Threshold**



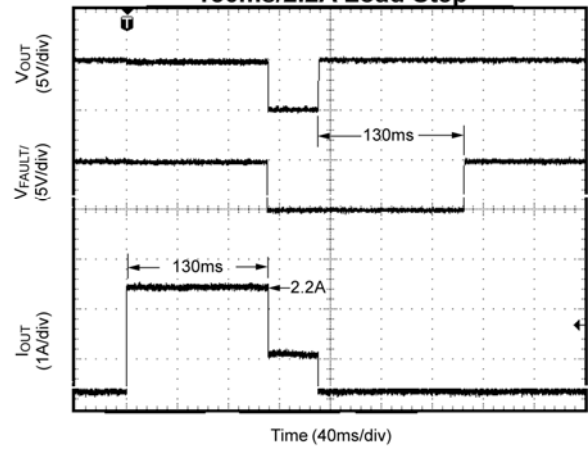
**Current Inrush Current Response**



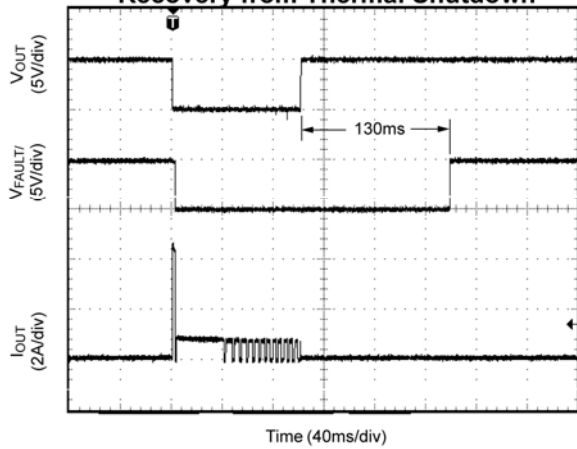
**Kickstart Response  
77ms/2.2A Load Step**



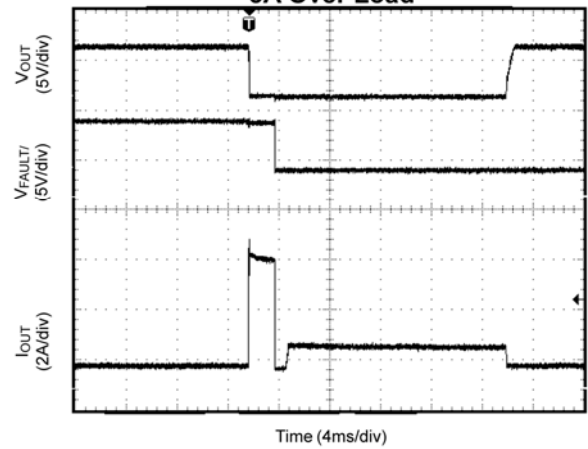
**Kickstart Response  
150ms/2.2A Load Step**



**Kickstart Response  
Recovery from Thermal Shutdown**



**Kickstart Response Time  
5A Over Load**



# Functional Diagram

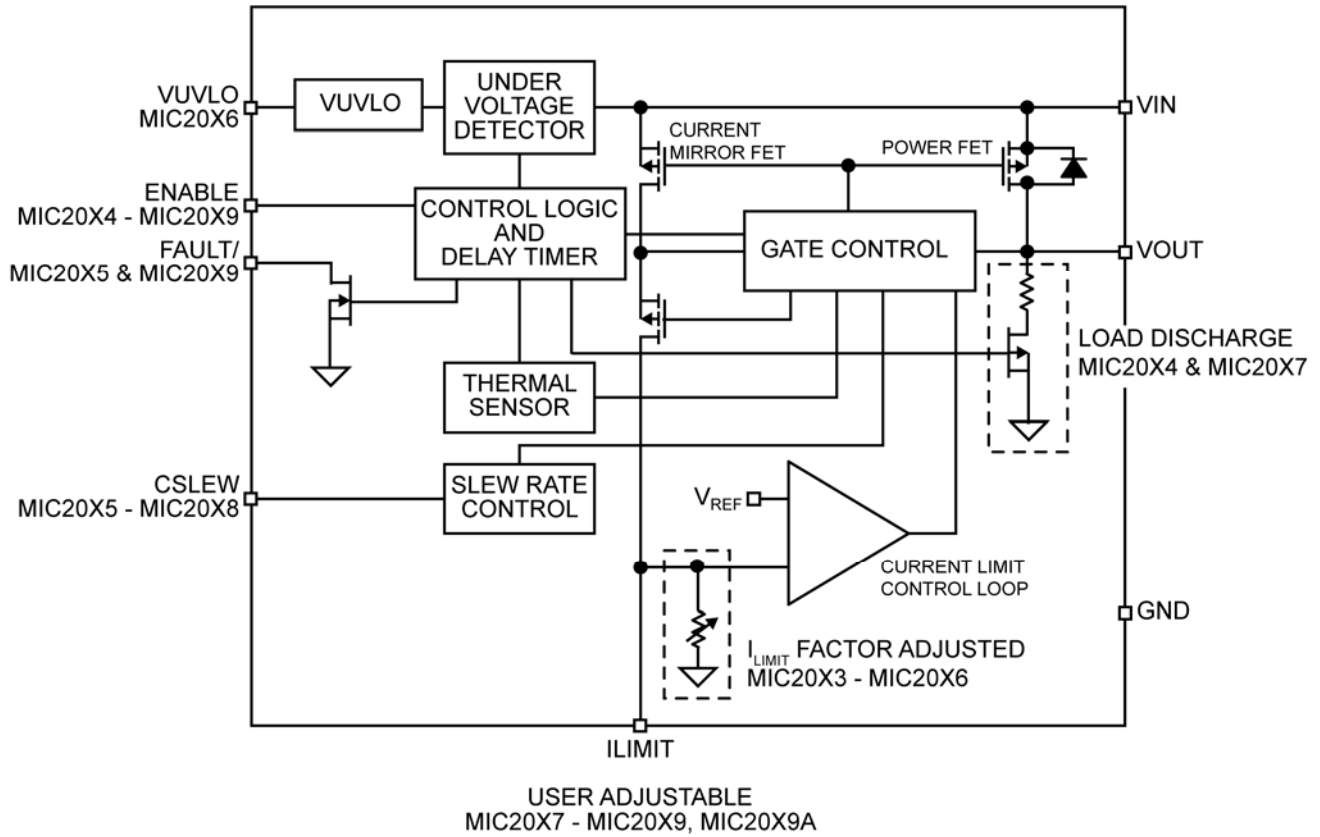


Figure 2. MIC20XX Family Functional Diagram

## Functional Description

### V<sub>IN</sub> and V<sub>OUT</sub>

V<sub>IN</sub> is both the power supply connection for the internal circuitry driving the switch and the input (Source connection) of the power MOSFET switch. V<sub>OUT</sub> is the Drain connection of the power MOSFET and supplies power to the load. In a typical circuit, current flows from V<sub>IN</sub> to V<sub>OUT</sub> toward the load. Since the switch is bi-directional when enabled, if V<sub>OUT</sub> is greater than V<sub>IN</sub>, current will flow from V<sub>OUT</sub> to V<sub>IN</sub>.

When the switch is disabled, current will not flow to the load, except for a small unavoidable leakage current of a few microamps. However, should V<sub>OUT</sub> exceed V<sub>IN</sub> by more than a diode drop (~0.6 V), while the switch is disabled, current will flow from output to input via the power MOSFET's body diode.

If discharging C<sub>LOAD</sub> is required by your application, consider using MIC20X4 or MIC20X7; these MIC20XX family members are equipped with a discharge FET to insure complete discharge of C<sub>LOAD</sub>.

### Current Sensing and Limiting

MIC20XX protects the system power supply and load from damage by continuously monitoring current through the on-chip power MOSFET. Load current is monitored by means of a current mirror in parallel with the power MOSFET switch. Current limiting is invoked when the load exceeds the set over-current threshold. When current limiting is activated the output current is constrained to the limit value, and remains at this level until either the load/fault is removed, the load's current requirement drops below the limiting value, or the switch goes into thermal shutdown.

### Kickstart™

2003	2004	2005X	2006	2007	2008	2009X
<b>2013</b>	<b>2014</b>	<b>2015</b>	<b>2016</b>	<b>2017</b>	<b>2018</b>	<b>2019X</b>

Only parts in bold have Kickstart™.  
(Not available in 5-pin SOT-23 packages)

The MIC201X is designed to allow momentary current surges (Kickstart™) before the onset of current limiting, which permits dynamic loads, such as small disk drives or portable printers to draw the energy needed to overcome inertial loads without sacrificing system safety. In this respect, the Kickstart™ parts (MIC201X) differs markedly from the non-Kickstart™ parts (MIC200X) which immediately limit load current, potentially starving the motor and causing the appliance to stall or stutter.

During this delay period, typically 128ms, a secondary current limit is in effect. If the load demands a current in excess the secondary limit, MIC201X acts immediately to restrict output current to the secondary limit for the duration of the Kickstart™ period. After this time the MIC201X reverts to its normal current limit. An example of Kickstart™ operation is shown in Figure 3.

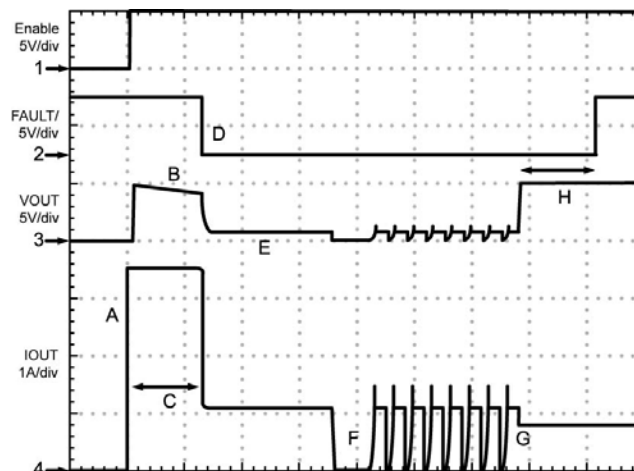


Figure 3. Kickstart™ Operation

### Figure 3 Label Key:

- A. MIC201X is enabled into an excessive load (slew rate limiting not visible at this time scale) The initial current surge is limited by either the overall circuit resistance and power supply compliance, or the secondary current limit, whichever is less.
- B. R<sub>ON</sub> of the power FET increases due to internal heating (effect exaggerated for emphasis).
- C. Kickstart™ period.
- D. Current limiting initiated. FAULT/ goes LOW.
- E. V<sub>OUT</sub> is non-zero (load is heavy, but not a dead short where V<sub>OUT</sub> = 0V. Limiting response will be the same for dead shorts).
- F. Thermal shutdown followed by thermal cycling.
- G. Excessive load released, normal load remains. MIC201X drops out of current limiting.
- H. FAULT/ delay period followed by FAULT/ going HIGH.

### Undervoltage Lock-Out

Undervoltage lock-out insures no anomalous operation occurs before the device's minimum input voltage of UVLO<sub>THRESHOLD</sub> which is 2V minimum, 2.25V typical, and 2.5V maximum had been achieved. Prior to reaching this voltage, the output switch (power MOSFET) is OFF and no circuit functions, such as FAULT/ or ENABLE, are considered to be valid or operative.

**Variable Undervoltage Lock Out (VUVLO)**

2003	2004	2005X	<b>2006</b>	2007	2008	2009X
2013	2014	2015	<b>2016</b>	2017	2018	2019X

Only parts in **bold** have VUVLO.

$V_{UVLO}$  functions as an input voltage monitor when the switch is enabled. The  $V_{IN}$  pin is monitored for a drop in voltage, indicating excessive loading of the  $V_{IN}$  supply. When  $V_{IN}$  is less than the  $V_{ULVO}$  threshold voltage ( $V_{VUVLO\_TH}$ ) for 32ms or more, the MIC20XX disables the switch to protect the supply and allow  $V_{IN}$  to recover. After 128ms has elapsed, the MIC20X6 enables switch. This disable and enable cycling will continue as long as  $V_{IN}$  decreases below the  $V_{UVLO}$  threshold voltage ( $V_{VUVLO\_TH}$ ) which has a typical value of 250mV. The  $V_{UVLO}$  voltage is commonly established by a voltage divider from  $V_{IN}$ -to-GND.

**ENABLE**

2003	<b>2004</b>	<b>2005X</b>	<b>2006</b>	<b>2007</b>	<b>2008</b>	<b>2009X</b>
2013	<b>2014</b>	<b>2015</b>	<b>2016</b>	<b>2017</b>	<b>2018</b>	<b>2019X</b>

Only parts in **bold** have ENABLE pin.

ENABLE pin is a logic compatible input which activates the main MOSFET switch thereby providing power to the  $V_{OUT}$  pin. ENABLE is either an active HIGH or active LOW control signal. The MIC20XX can operate with logic running from supply voltages as low as 1.5 V.

ENABLE may be driven higher than  $V_{IN}$ , but no higher than 5.5V and not less than  $-0.3V$ .

**FAULT/**

2003	2004	<b>2005X</b>	2006	2007	2008	<b>2009X</b>
2013	2014	<b>2015</b>	2016	2017	2018	<b>2019X</b>

Only parts in **bold** have FAULT/ pin.

FAULT/ is an N-channel open-drain output, which is asserted (LOW true) when switch either begins current limiting or enters thermal shutdown.

FAULT/ asserts after a brief delay when events occur that may be considered possible faults. This delay insures that FAULT/ is asserted only upon valid, enduring, over-current conditions and that transitory event error reports are filtered out.

In MIC200X FAULT/ asserts after a brief delay period, of 32ms typical. After a fault clears, FAULT/ remains asserted for the delay period of 32ms

MIC201X's FAULT/ asserts at the end of the Kickstart™ period which is 128ms typical. This masks initial current surges, such as would be seen by a motor load starting up. If the load current remains above the current limit threshold after the Kickstart™ has timed out, then the FAULT/ will be asserted. After a fault clears, FAULT/ remains asserted for the delay of 128ms.

Because FAULT/ is an open-drain it must be pulled HIGH with an external resistor and it may be wire-OR'd with other similar outputs, sharing a single pull-up resistor. FAULT/ may be tied to a pull-up voltage source which is higher than  $V_{IN}$ , but no greater than 5.5V.

**Soft-Start Control**

Large capacitive loads can create significant inrush current surges when charged through the switch. For this reason, the MIC20XX family of switches provides a built-in soft-start control to limit the initial inrush currents.

Soft-start is accomplished by controlling the power MOSFET when the ENABLE pin enables the switch.

 **$C_{SLEW}$** 

2003	2004	<b>2005X</b>	<b>2006</b>	<b>2007</b>	<b>2008</b>	2009X
2013	2014	<b>2015</b>	<b>2016</b>	<b>2017</b>	<b>2018</b>	2019X

Only parts in **bold** have  $C_{SLEW}$  pin.  
(Not available in 5-pin SOT-23 packages)

The  $C_{SLEW}$  pin is provided to increase control of the output voltage ramp at turn-on. This input allows designers the option of decreasing the output's slew rate (slowing the voltage rise) by adding an external capacitance between the  $C_{SLEW}$  and  $V_{IN}$  pins.

**Thermal Shutdown**

Thermal shutdown is employed to protect the MIC20XX family of switches from damage should the die temperature exceed safe operating levels. Thermal shutdown shuts off the output MOSFET and asserts the FAULT/ output if the die temperature reaches 145°C.

The switch will automatically resume operation when the die temperature cools down to 135°C. If resumed operation results in reheating of the die, another shutdown cycle will occur and the switch will continue cycling between ON and OFF states until the overcurrent condition has been resolved.

Depending on PCB layout, package type, ambient temperature, etc., hundreds of milliseconds may elapse from the incidence of a fault to the output MOSFET being shut off. This delay is due to thermal time constants within the system itself. In no event will the device be damaged due to thermal overload because die temperature is monitored continuously by on-chip circuitry.

## Application Information

### Setting I<sub>LIMIT</sub>

The MIC2009/2019's current limit is user programmable and controlled by a resistor connected between the I<sub>LIMIT</sub> pin and GND. The value of this resistor is determined by the following equation:

$$I_{LIMIT} = \frac{\text{CurrentLimitFactor}(CLF)}{R_{SET}}$$

or

$$R_{SET} = \frac{\text{CurrentLimitFactor}(CLF)}{I_{LIMIT} (A)}$$

For example: Set I<sub>LIMIT</sub> = 1.25A

Looking in the Electrical specifications we will find CLF at I<sub>LIMIT</sub> = 1A.

Min	Typ	Max	Units
190	243	293	V

**Table 1. CLF at I<sub>LIMIT</sub> = 1A**

For the sake of this example, we will say the typical value of CLF at an I<sub>OUT</sub> of 1A is 243V. Applying the equation above:

$$R_{SET} (\Omega) = \frac{243V}{1.25A} = 194.4\Omega$$

$$R_{SET} = 196\Omega$$

(the closest standard 1% value)

Designers should be aware that variations in the measured I<sub>LIMIT</sub> for a given R<sub>SET</sub> resistor, will occur because of small differences between individual ICs (inherent in silicon processing) resulting in a spread of I<sub>LIMIT</sub> values. In the example above we used the typical value of CLF to calculate R<sub>SET</sub>. We can determine I<sub>LIMIT</sub>'s spread by using the minimum and maximum values of CLF and the calculated value of R<sub>SET</sub>.

$$I_{LIMIT\_MIN} = \frac{190V}{196\Omega} = 0.97A$$

$$I_{LIMIT\_MAX} = \frac{293V}{196\Omega} = 1.5A$$

Giving us a maximum I<sub>LIMIT</sub> variation over temperature of:

$$I_{LIMIT\_MIN} \quad I_{LIMIT\_TYP} \quad I_{LIMIT\_MAX}$$

0.97A (-22%)      1.25A      1.5A (+20%)

I <sub>OUT</sub>	R <sub>SET</sub>	I <sub>LIMIT\_MIN</sub>	I <sub>LIMIT\_MAX</sub>
0.1A	1928Ω	0.063A	0.136A
0.2A	993Ω	0.137A	0.265A
0.3A	673Ω	0.216A	0.391A
0.4A	511Ω	0.296A	0.515A
0.5A	413Ω	0.379A	0.637A
0.6A	346Ω	0.463A	0.759A
0.7A	299Ω	0.548A	0.880A
0.8A	263Ω	0.634A	1.001A
0.9A	235Ω	0.722A	1.121A

**Table 2. MIC20x9A R<sub>SET</sub> Table**

I <sub>OUT</sub>	R <sub>SET</sub>	I <sub>LIMIT\_MIN</sub>	I <sub>LIMIT\_MAX</sub>
0.2A	1125Ω	0.127A	0.267A
0.3A	765Ω	0.202A	0.390A
0.4A	582Ω	0.281A	0.510A
0.5A	470Ω	0.361A	0.629A
0.6A	395Ω	0.443A	0.746A
0.7A	341Ω	0.526A	0.861A
0.8A	300Ω	0.610A	0.976A
0.9A	268Ω	0.695A	1.089A
1A	243Ω	0.781A	1.202A
1.1A	222Ω	0.868A	1.314A
1.2A	204Ω	0.956A	1.426A
1.3A	189Ω	1.044A	1.537A
1.4A	176Ω	1.133A	1.647A
1.5A	165Ω	1.222A	1.757A

**Table 3. MIC20x9 R<sub>SET</sub> Table**



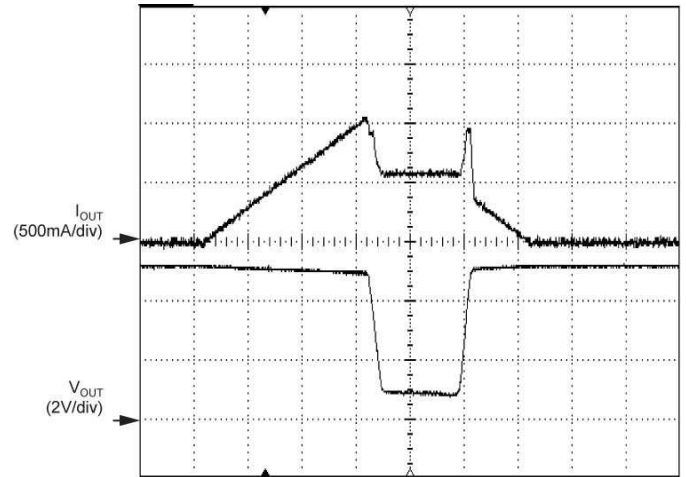
**$I_{LIMIT}$  vs.  $I_{OUT}$  Measured**

The MIC20XX's current-limiting circuitry, during current limiting, is designed to act as a constant current source to the load. As the load tries to pull more than the allotted current,  $V_{OUT}$  drops and the input to output voltage differential increases. When  $V_{IN} - V_{OUT}$  exceeds 1V,  $I_{OUT}$  drops below  $I_{LIMIT}$  to reduce the drain of fault current on the system's power supply and to limit internal heating of the switch.

When measuring  $I_{OUT}$  it is important to bear this voltage dependence in mind, otherwise the measurement data may appear to indicate a problem when none really exists. This voltage dependence is illustrated in Figures 4 and 5.

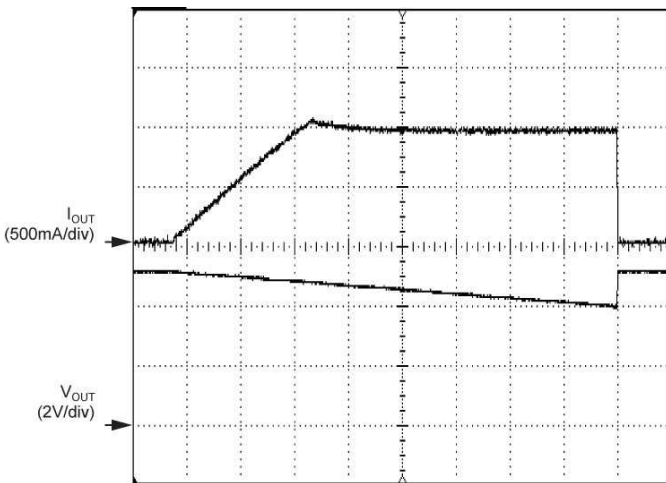
In Figure 4, output current is measured as  $V_{OUT}$  is pulled below  $V_{IN}$ , with the test terminating when  $V_{OUT}$  is 1V below  $V_{IN}$ . Observe that once  $I_{LIMIT}$  is reached  $I_{OUT}$  remains constant throughout the remainder of the test. In Figure 5 this test is repeated but with  $V_{IN} - V_{OUT}$  exceeding 1V.

When  $V_{IN} - V_{OUT} > 1V$ , switch's current limiting circuitry responds by decreasing  $I_{OUT}$ , as can be seen in Figure 5. In this demonstration,  $V_{OUT}$  is being controlled and  $I_{OUT}$  is the measured quantity. In real life applications  $V_{OUT}$  is determined in accordance with  $\Omega$ 's law by the load and the limiting current.

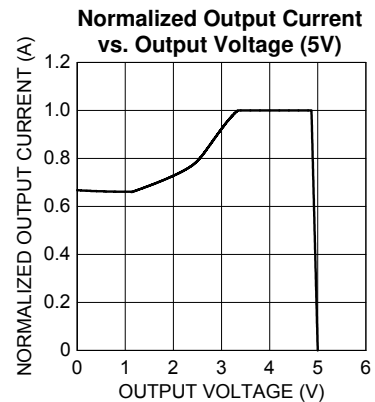


**Figure 5.  $I_{OUT}$  in Current Limiting for  $V_{IN} - V_{OUT} > 1V$**

This folding back of  $I_{LIMIT}$  can be generalized by plotting  $I_{LIMIT}$  as a function of  $V_{OUT}$ , as shown below in Figures 6 and 7. The slope of  $V_{OUT}$  between  $I_{OUT} = 0V$  and  $I_{OUT} = I_{LIMIT}$  (where  $I_{LIMIT} = 1A$ ) is determined by  $R_{ON}$  of the switch and  $I_{LIMIT}$ .



**Figure 4.  $I_{OUT}$  in Current Limiting for  $V_{IN} - V_{OUT} < 1V$**



**Figure 6. Normalized Output Current vs. Output Voltage**

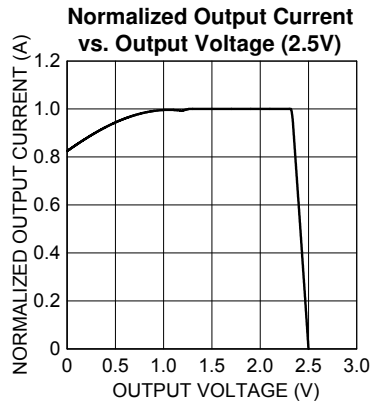


Figure 7. Normalized Output Current vs. Output Voltage

**C<sub>SLEW</sub>**

2003	2004	<b>2005X</b>	<b>2006</b>	<b>2007</b>	<b>2008</b>	2009X
2013	2014	<b>2015</b>	<b>2016</b>	<b>2017</b>	<b>2018</b>	2019X

Only parts in **bold** have CSLEW pin.  
(Not available in 5-pin SOT-23 packages).

The C<sub>SLEW</sub> pin is provided to increase control of the output voltage ramp at turn-on. This input allows designers the option of decreasing the output's slew rate (slowing the voltage rise) by adding an external capacitance between the C<sub>SLEW</sub> and V<sub>IN</sub> pins. This capacitance slows the rate at which the pass FET gate voltage increases and thus, slows both the response to an Enable command as well as V<sub>OUT</sub>'s ascent to its final value.

Figure 8 illustrates effect of C<sub>SLEW</sub> on turn-on delay and output rise time.

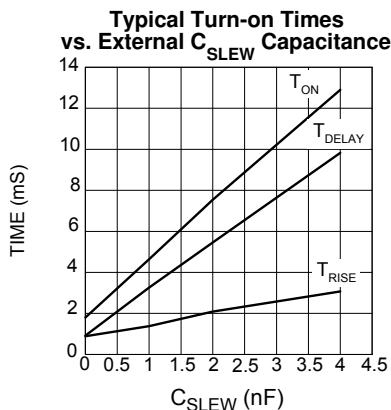


Figure 8. C<sub>SLEW</sub> vs. Turn-On, Delay and Rise Times

**C<sub>SLEW</sub>'s Effect on I<sub>LIMIT</sub>**

An unavoidable consequence of adding C<sub>SLEW</sub> capacitance is a reduction in the MIC20X5 – 20X8's ability to quickly limit current transients or surges. A sufficiently large capacitance can prevent both the primary and secondary current limits from acting in time to prevent damage to the MIC20X5 – 20X8 or the system from a short circuit fault. For this reason, the upper limit on the value of C<sub>SLEW</sub> is 4nF.

**Variable Undervoltage Lock Out (VUVLO)**

2003	2004	2005X	<b>2006</b>	2007	2008	2009X
2013	2014	2015	<b>2016</b>	2017	2018	2019X

Only parts in **bold** have VUVLO pin and functionality.

Power-conscious systems, such as those implementing ACPI, will remain active even in their low-power states and may require the support of external devices through both phases of operation. Under these conditions, the current allowed these external devices may vary according to the system's operating state and as such require dual current limits on their peripheral ports. The MIC20X6 is designed for systems demanding two primary current limiting levels but without the use of a control signal to select between current limits.

To better understand how the MIC20X6 provides this, imagine a system whose main power supply supports heavy loads during normal operation, but in sleep mode is reduced to only few hundred milliamps of output current. In addition, this system has several USB ports which must remain active during sleep. During normal operation, each port can support a 500mA peripheral, but in sleep mode their combined output current is limited to what the power supply can deliver minus whatever the system itself is drawing.

If a peripheral device is plugged in which demands more current than is available, the system power supply will sag, or crash. The MIC20X6 prevents this by monitoring both the load current and V<sub>IN</sub>. During normal operation, when the power supply can source plenty of current, the MIC20X6 will support any load up to its factory programmed current limit. When the weaker, standby supply is in operation, the MIC20X6 monitors V<sub>IN</sub> and will shut off its output should V<sub>IN</sub> dip below a predetermined value. This predetermined voltage is user programmable and set by the selection of the resistor divider driving the VUVLO pin.

To prevent false triggering of the VUVLO feature, the MIC20X6 includes a delay timer to blank out momentary excursions below the VUVLO trip point. If  $V_{IN}$  stays below the VUVLO trip point for longer than 32ms (typical), then the load is disengaged and the MIC20X6 will wait 128ms before reapplying power to the load. If  $V_{IN}$  remains below the VUVLO trip point, then the load will be powered for the 32ms blanking period and then again disengaged. This is illustrated in the scope plot below. If  $V_{IN}$  remains above the VUVLO trip point MIC20X6 resumes normal operation.

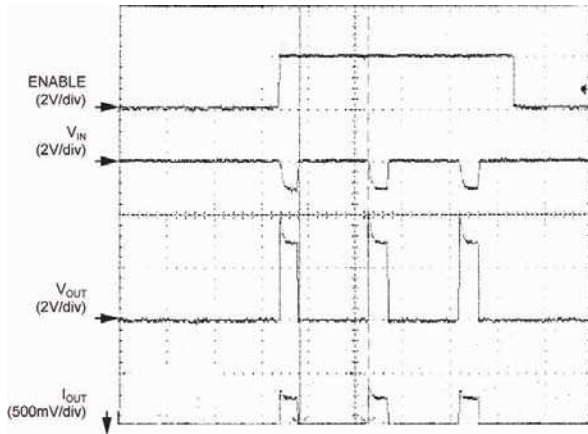


Figure 9. VUVLO Operation

VUVLO and Kickstart™ operate independently in the MIC2016. If the high-current surge allowed by Kickstart™ causes  $V_{IN}$  to dip below the VUVLO trip point for more than 32ms, VUVLO will disengage the load, even though the Kickstart™ timer has not timed out.

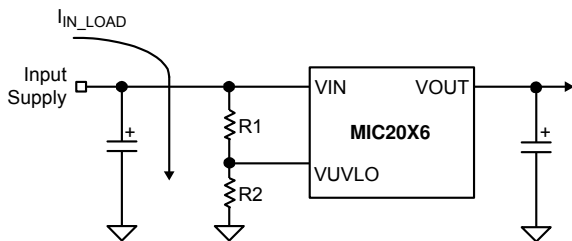


Figure 10. VUVLO Application Circuit

### Calculating VUVLO Resistor Divider Values

The VUVLO feature is designed to keep the internal switch off until the voltage on the VUVLO pin is greater than 0.25V. A resistor divider network connected to the VUVLO and VIN pins is used to set the input trip voltage  $V_{TRIP}$  (see Figure 10). The value of R2 is chosen to minimize the load on the input supply  $I_{DIV}$  and the value of R1 sets the trip voltage  $V_{TRIP}$ .

The value of R2 is calculated using:

$$R2 = \frac{V_{VUVLO}}{I_{DIV}}$$

The value of R1 is calculated using:

$$R1 = R2 \times \left( \frac{V_{TRIP}}{V_{VUVLO}} - 1 \right)$$

Where for both equations:

$$V_{VUVLO} = 0.25V$$

When working with large value resistors, a small amount of leakage current from the VUVLO terminal can cause voltage offsets that degrade system accuracy. Therefore, the maximum recommended resistor value for R2 is 100kΩ.

Using the divider loading current  $I_{DIV}$  of 100μA, the value of R2 can be estimated by:

$$R2 = \frac{0.25V}{100\mu A} = 2.5k\Omega$$

Now the value of R1 can be calculated by:

$$R1 = 2.5k\Omega \times \left( \frac{4.75V}{0.25V} - 1 \right) = 45k$$

where:

$$V_{TRIP} = 4.75V \text{ (for a 5V supply)}$$

$$V_{VUVLO} = 0.25V$$

The VUVLO comparator uses no hysteresis. This is because the VUVLO blanking timer prevents any chattering that might otherwise occur if  $V_{IN}$  varies about the trigger point. The timer is reset by upward crossings of the trip point such that  $V_{IN}$  must remain below the trip point for the full 32ms period for load disengagement to occur.

In selecting a  $V_{TRIP}$  voltage, the designer is cautioned to not make this value less than 2.5V. A minimum of 2.5V is required for the MIC20X6's internal circuitry to operate properly. VUVLO trip points below 2.5V will result in erratic or unpredictable operation.

**Kickstart™**

2003	2004	2005X	2006	2007	2008	2009X
<b>2013</b>	<b>2014</b>	<b>2015</b>	<b>2016</b>	<b>2017</b>	<b>2018</b>	<b>2019X</b>

Only parts in **bold** have Kickstart™.  
(Not available in 5-pin SOT-23 packages).

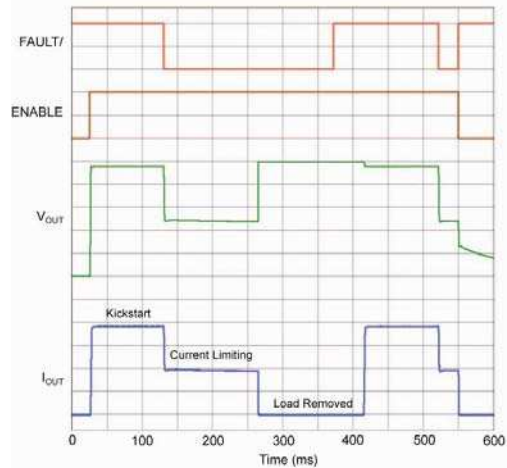
Kickstart™ allows brief current surges to pass to the load before the onset of normal current limiting, which permits dynamic loads to draw bursts of energy without sacrificing system safety.

Functionally, Kickstart™ is a forced override of the normal current limiting function provided by the switch. The Kickstart™ period is governed by an internal timer which allows current to pass up to the secondary current limit ( $I_{LIMIT\_2nd}$ ) to the load for 128ms and then normal (primary) current limiting goes into action.

During Kickstart™, a secondary current-limiting circuit is monitoring output current to prevent damage to the switch, as a hard short combined with a robust power supply can result in currents of many tens of amperes. This secondary current limit is nominally set at 4A and reacts immediately and independently of the Kickstart™ period. Once the Kickstart™ timer has finished its count the primary current limiting circuit takes over and holds  $I_{OUT}$  to its programmed limit for as long as the excessive load persists.

Once the switch drops out of current limiting the Kickstart™ timer initiates a lock-out period of 128ms such that no further bursts of current above the primary current limit, will be allowed until the lock-out period has expired.

Kickstart™ may be over-ridden by the thermal protection circuit and if sufficient internal heating occurs, Kickstart™ will be terminated and  $I_{OUT} \rightarrow 0A$ . Upon cooling, if the load is still present  $I_{OUT} \rightarrow I_{LIMIT}$ , not  $I_{LIMIT\_2nd}$ .



**Figure 11. Kickstart™**

**Automatic Load Discharge**

2003	<b>2004</b>	2005X	2006	<b>2007</b>	2008	2009X
2013	<b>2014</b>	2015	2016	<b>2017</b>	2018	2019X

Only parts in **bold** have automatic load discharge.

Automatic discharge is a valuable feature when it is desirable to quickly remove charge from the  $V_{OUT}$  pin. This allows for a quicker power-down of the load. This also prevents any charge from being presented to a device being connected to the  $V_{OUT}$  pin, for example, USB, 1394, PCMCIA, and CableCARD™.

Automatic discharge is performed by a shunt MOSFET from  $V_{OUT}$  pin to GND. When the switch is disabled, a break before make action is performed turning off the main power MOSFET and then enabling the shunt MOSFET. The total resistance of the MOSFET and internal resistances is typically 126Ω.

**Supply Filtering**

A minimum 1μF bypass capacitor positioned close to the  $V_{IN}$  and GND pins of the switch is both good design practice and required for proper operation of the switch. This will control supply transients and ringing. Without a bypass capacitor, large current surges or a short may cause sufficient ringing on  $V_{IN}$  (from supply lead inductance) to cause erratic operation of the switch's control circuitry. For best-performance good quality, low-ESR capacitors are recommended, preferably ceramic.

When bypassing with capacitors of 10μF and up, it is good practice to place a smaller value capacitor in parallel with the larger to handle the high frequency components of any line transients. Values in the range of 0.01μF to 0.1μF are recommended. Again, good quality, low-ESR capacitors should be chosen.

**Power Dissipation**

Power dissipation depends on several factors such as the load, PCB layout, ambient temperature, and supply voltage. Calculation of power dissipation can be accomplished by the following equation:

$$P_D = R_{DS(ON)} \times (I_{OUT})^2$$

To relate this to junction temperature, the following equation can be used:

$$T_J = P_D \times R_{\theta(J-A)} + T_A$$

where:

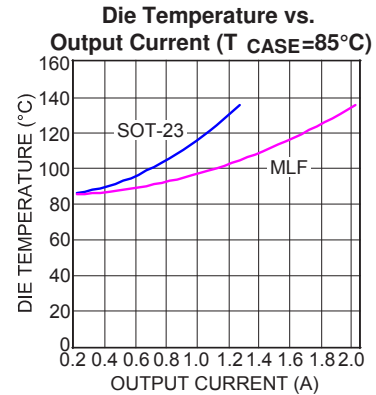
$T_J$  = junction temperature

$T_A$  = ambient temperature

$R_{\theta(J-A)}$  is the thermal resistance of the package

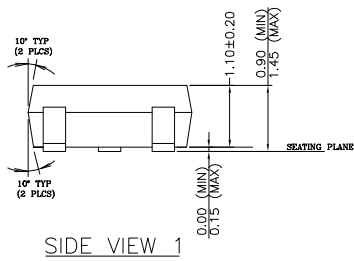
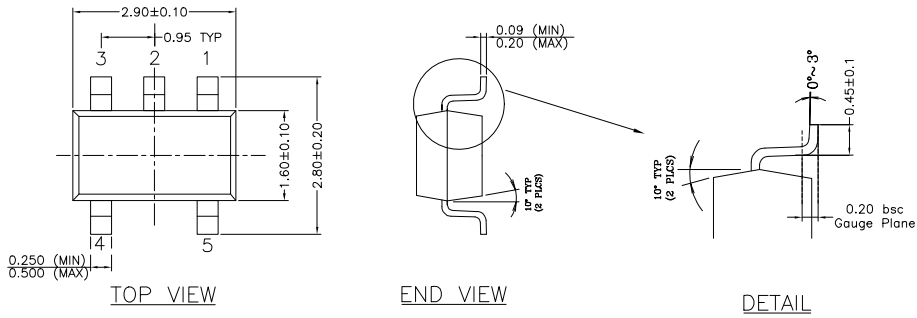
In normal operation the switch's  $R_{ON}$  is low enough that no significant  $I^2R$  heating occurs. Device heating is most often caused by a short circuit, or very-heavy load, when a significant portion of the input supply voltage appears across the switch's power MOSFET. Under these conditions the heat generated will exceed the package and PCB's ability to cool the device and thermal limiting will be invoked.

In Figure 12, die temperature is plotted against  $I_{OUT}$  assuming a constant case temperature of 85°C. The plots also assume a worst case  $R_{ON}$  of 140mΩ at a die temperature of 135°C. Under these conditions it is clear that an SOT-23 packaged device will be on the verge of thermal shutdown, typically 140°C die temperature, when operating at a load current of 1.25A. For this reason we recommend using MLF<sup>®</sup> packaged switches for any design intending to supply continuous currents of 1A or more.



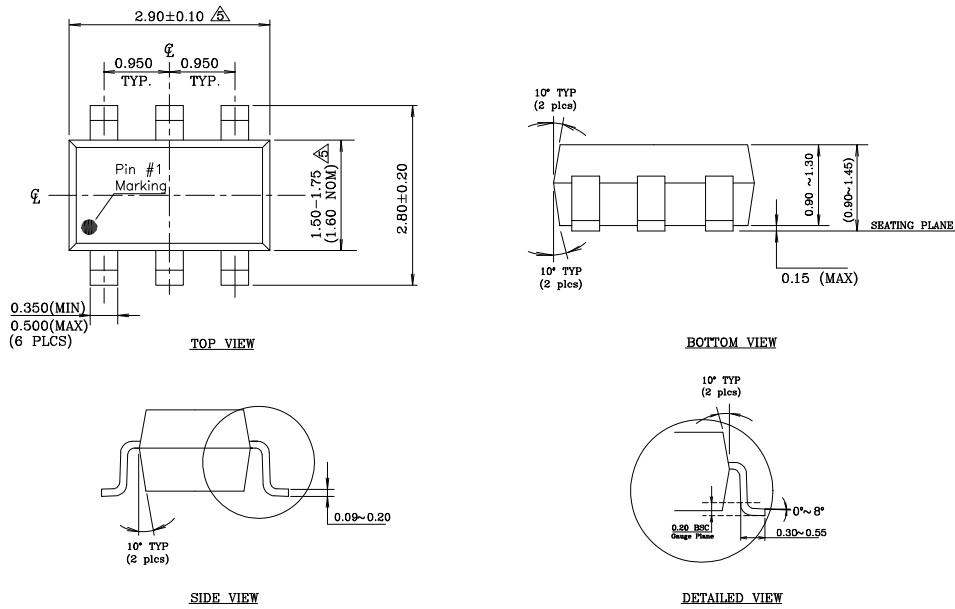
**Figure 12. Die Temperature vs.  $I_{OUT}$**

Package Information



NOTE:  
 1. PACKAGE OUTLINE EXCLUSIVE OF MOLD FLASH & BURR.  
 2. PACKAGE OUTLINE INCLUSIVE OF SOLER PLATING.  
 3. DIMENSION AND TOLERANCE PER ANSI Y14.5M, 1982.  
 4. FOOT LENGTH MEASUREMENT BASED ON GAUGE PLANE METHOD.  
 5. DIE FACES UP FOR MOLD, AND FACES DOWN FOR TRIM/FORM.  
 6. ALL DIMENSIONS ARE IN MILLIMETERS.

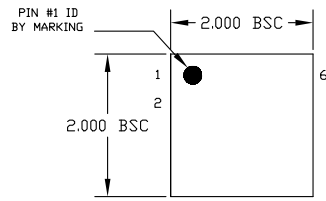
5-Pin SOT-23 (M5)



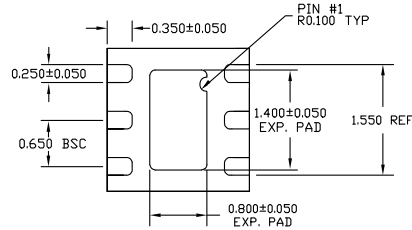
NOTE:  
 1. Dimensions and tolerances are as per ANSI Y14.5M, 1982.  
 2. Package surface to be mirror finish.  
 3. Die is facing up for mold. Die is facing down for trim/form, ie. reverse trim/form.  
 4. The footlength measuring is based on the gauge plane method.  
 5. Dimension are exclusive of mold flash & gate burr.

6-Pin SOT-23 (M6)

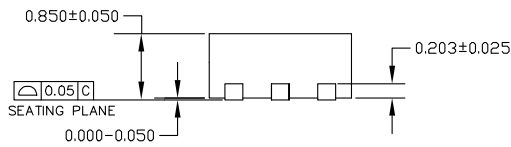
**Package Information (Continued)**



TOP VIEW



BOTTOM VIEW



SIDE VIEW

- NOTE:
1. ALL DIMENSIONS ARE IN MILLIMETERS.
  2. MAX. PACKAGE WARPAGE IS 0.05 mm.
  3. MAXIMUM ALLOWABLE BURRS IS 0.076 mm IN ALL DIRECTIONS.
  4. PIN #1 ID ON TOP WILL BE LASER MARKED.

**6 Pin 2mm x 2mm MLF<sup>®</sup> (ML)**

**Section 1.01 MICREL, INC. 2180 FORTUNE DRIVE SAN JOSE, CA 95131 USA**  
 TEL +1 (408) 944-0800 FAX +1 (408) 474-1000 WEB <http://www.micrel.com>

Micrel makes no representations or warranties with respect to the accuracy or completeness of the information furnished in this data sheet. This information is not intended as a warranty and Micrel does not assume responsibility for its use. Micrel reserves the right to change circuitry, specifications and descriptions at any time without notice. No license, whether express, implied, arising by estoppel or otherwise, to any intellectual property rights is granted by this document. Except as provided in Micrel's terms and conditions of sale for such products, Micrel assumes no liability whatsoever, and Micrel disclaims any express or implied warranty relating to the sale and/or use of Micrel products including liability or warranties relating to fitness for a particular purpose, merchantability, or infringement of any patent, copyright or other intellectual property right.

Micrel Products are not designed or authorized for use as components in life support appliances, devices or systems where malfunction of a product can reasonably be expected to result in personal injury. Life support devices or systems are devices or systems that (a) are intended for surgical implant into the body or (b) support or sustain life, and whose failure to perform can be reasonably expected to result in a significant injury to the user. A Purchaser's use or sale of Micrel Products for use in life support appliances, devices or systems is a Purchaser's own risk and Purchaser agrees to fully indemnify Micrel for any damages resulting from such use or sale.

© 2009 Micrel, Incorporated.